



**NEW
FORMAT**

AJ Sadler

**Mathematics
Specialist**

Student Book

Units 3 & 4



Mathematics Specialist Units 3 & 4

1st revised Edition

A J Sadler

Publishing editor: Robert Yen

Project editor: Alan Stewart

Cover design: Chris Starr (MakeWork)

Text designers: Sarah Anderson, Nicole Melbourne,
Danielle Maccarone

Permissions researcher: Helen Mammides

Answer checker: George Dimitriadis

Production controller: Erin Dowling

Typeset by: Nikki M Group Pty Ltd

Any URLs contained in this publication were checked for currency during the production process. Note, however, that the publisher cannot vouch for the ongoing currency of URLs.

Acknowledgements

Text design images in Chapter 8 pages 205, 209; Chapter 9 page 240: Shutterstock.com/Denis Cristo

Text design image in Chapter 5 page 115: Shutterstock.com/galimova79



© 2017 A J Sadler

Copyright Notice

This Work is copyright. No part of this Work may be reproduced, stored in a retrieval system, or transmitted in any form or by any means without prior written permission of the Publisher. Except as permitted under the *Copyright Act 1968*, for example any fair dealing for the purposes of private study, research, criticism or review, subject to certain limitations. These limitations include: Restricting the copying to a maximum of one chapter or 10% of this book, whichever is greater; providing an appropriate notice and warning with the copies of the Work disseminated; taking all reasonable steps to limit access to these copies to people authorised to receive these copies; ensuring you hold the appropriate Licences issued by the Copyright Agency Limited ("CAL"), supply a remuneration notice to CAL and pay any required fees. For details of CAL licences and remuneration notices please contact CAL at Level 15, 233 Castlereagh Street, Sydney NSW 2000, Tel: (02) 9394 7600, Fax: (02) 9394 7601
Email: info@copyright.com.au
Website: www.copyright.com.au

For product information and technology assistance,
in Australia call **1300 790 853**;
in New Zealand call **0800 449 725**

For permission to use material from this text or product, please email aust.permissions@cengage.com

National Library of Australia Cataloguing-in-Publication Data

Sadler, A. J., author.

Mathematics specialist. Units 3 & 4 / A J Sadler.

1st revised edition
9780170395274 (paperback)
For secondary school age.

Mathematics--Study and teaching (Secondary)--Australia.

Mathematics--Problems, exercises, etc.

Mathematics--Textbooks

Cengage Learning Australia

Level 7, 80 Dorcas Street
South Melbourne, Victoria Australia 3205

Cengage Learning New Zealand

Unit 4B Rosedale Office Park
331 Rosedale Road, Albany, North Shore 0632, NZ

For learning solutions, visit cengage.com.au

Printed in China by China Translation & Printing Services.

1 2 3 4 5 6 7 21 20 19 18 17

PREFACE

This text targets Units Three and Four of the West Australian course *Mathematics Specialist*, a course that is organised into four units altogether, the first two for year eleven and the last two for year twelve.

This West Australian course, *Mathematics Specialist*, is based on the Australian Curriculum Senior Secondary course *Specialist Mathematics*. With only very slight differences between the Unit Three content of these two courses this text is also suitable for anyone following Unit Three of the Australian Curriculum course, *Specialist Mathematics*. For Unit Four, the West Australian course omits some topics that are in the Australian Curriculum, these being the inverse trigonometric functions, integration by parts, exponential random variables, and some applications involving force. Integration by parts is included in this text as an extension activity and the companion volume for *Mathematics Methods* Unit Four includes some questions involving exponential random variables. The inverse trigonometric functions feature in this text in one question of a Miscellaneous Exercise. The applications involving force are not included in this text.

The book contains text, examples and exercises containing many carefully graded questions. A student who studies the appropriate text and relevant examples should make good progress with the exercise that follows.

Each unit commences with a section entitled **Preliminary work**. This section briefly outlines work of particular relevance to the unit and that students should either already have some familiarity with from the mathematics studied in earlier years, or for which the brief outline included in the section may be sufficient to bring the understanding of the concept up to the necessary level.



A **Miscellaneous exercise** features at the end of each chapter and includes questions involving work from preceding chapters, and from the *Preliminary work* section.

A few chapters commence with, or contain, a '**Situation**' or two for students to consider. Answers to these situations are generally not included in the book. Students should be encouraged to discuss their solutions and answers to these situations.

At times in this series of books I have found it appropriate to go a little beyond the confines of the syllabus for the unit involved. In this regard, when considering the absolute value function, and to meet the syllabus requirement to 'use and apply' $|x|$ and the graph of $y = |x|$, I include solving equations and inequalities involving absolute values. With vectors, when considering whether two moving objects meet, or whether their paths cross, I also consider the closest approach situation. In Unit Four, when using a substitution to integrate expressions, I do not limit such considerations to expressions of the form $f(g(x))g'(x)$. For integration by numerical methods I mention the Trapezium rule and Simpson's rule and when considering differential equations I include Euler's method. With sampling I include mention of a significant difference at the 5% level.

I leave it up to the readers, and teachers, to decide whether to cover these aspects.

Alan Sadler

CONTENTS

UNIT THREE

PRELIMINARY WORK **viii**

Number.....	viii
The absolute value.....	ix
Function.....	ix
Algebra.....	x
Vectors.....	xi
Complex numbers.....	xvi
Circles.....	xviii
Differentiation.....	xix
Sketching graphs.....	xx
Antidifferentiation.....	xxi
Trigonometrical identities.....	xxii
Matrices.....	xxii
Use of technology.....	xxiii

1

COMPLEX NUMBERS, A REMINDER **2**

A reminder.....	3
Algebraic fractions.....	5
The remainder theorem.....	6
The factor theorem.....	6
Miscellaneous exercise one.....	9

2

POLAR FORM OF A COMPLEX NUMBER **12**

Polar form of a complex number.....	13
The abbreviated form for $\cos\theta + i\sin\theta$	16
Multiplying and dividing complex numbers expressed in polar form.....	18

Geometrical interpretation.....	19
Regions in the complex plane.....	22
The cube roots of 1.....	27
Nth roots of a non zero complex number.....	28
De Moivre's theorem.....	31
Miscellaneous exercise two.....	36

3

FUNCTIONS **38**

One-to-one and many-to-one.....	39
Combining functions.....	40
Using the output from one function as the input of another.....	42
Domain and range of functions of the form $f \circ g(x)$	43
Inverse functions.....	49
Graphical relationship between a function and its inverse.....	51
Condition for the inverse to exist as a function.....	51
The absolute value function.....	56
The absolute value of x as $\sqrt{x^2}$	57
Solving equations involving absolute values.....	58
Solving inequalities involving absolute values.....	62
The graph of $y = \frac{1}{f(x)}$	67
The graph of $y = \frac{f(x)}{g(x)}$ for $f(x)$ and $g(x)$ polynomials.....	69
Absolute value – extension activity.....	77
Rational functions – extension activity.....	78
Miscellaneous exercise three.....	79

4

VECTOR EQUATION OF A LINE IN THE x - y PLANE **82**

Interception/collision.....	84
Vector equation of a straight line in the x - y plane.....	88
Point of intersection of two straight lines.....	95
Scalar product form of the equation of a straight line in the x - y plane.....	98
Vector equations of curves in the x - y plane.....	101
Vector equations of circles in the x - y plane.....	101
Closest approach.....	107
Distance from a point to a line.....	109
Miscellaneous exercise four.....	111

5

VECTORS IN THREE DIMENSIONS **114**

Three-dimensional vectors.....	117
The angle between two lines.....	118
Vector product (cross product).....	124
Vector equation of a line.....	126
Vector equation of a plane.....	128
Given three points that lie in the plane.....	131
Interception/collision.....	133
Vector equation of a sphere.....	137
Distance from a point to a line revisited.....	140
Miscellaneous exercise five.....	142



6

SYSTEMS OF LINEAR EQUATIONS 146

Systems of equations	148
A systematic algebraic approach for solving systems of linear equations using a matrix form of presentation (and otherwise)	149
Calculators and row echelon form	151
Systems of linear equations having no solution	157
Systems of linear equations having infinitely many solutions.....	159
Miscellaneous exercise six.....	167

7

VECTOR CALCULUS 170

Differentiating vector functions	171
Integrating vector functions	174
Some particular types of motion. . .	178
Miscellaneous exercise seven	182

UNIT FOUR**PRELIMINARY WORK 191**

Differentiation	191
Antidifferentiation and integration .	191
Statistics	191
Trigonometric identities	192
Limit of a sum.....	193
Use of technology.....	193

8

DIFFERENTIATION TECHNIQUES AND APPLICATIONS 194

Explicitly defined and implicitly defined functions	195
Differentiation of implicitly defined functions	195

Differentiation of parametrically defined functions	200
Related rates.....	202
Small changes	211
Marginal rates of change.....	211
Logarithmic differentiation.....	213
Miscellaneous exercise eight	214

9

INTEGRATION TECHNIQUES AND APPLICATIONS 216

Integration by substitution (or change of variable)	217
Definite integrals and the change of variable method	221
Use of trigonometric identities to assist integration	223
Integration to give logarithmic functions.....	227
More about partial fractions	230
Volumes of revolution.....	232
Rotation about the y-axis	232
Numerical integration.....	236
Extension: Integration by parts.....	238
Miscellaneous exercise nine	239

10

DIFFERENTIAL EQUATIONS 242

Differential equations.....	244
Differential equations of the form $\frac{dA}{dt} = kA$, or $\dot{x} = kx$	247
The logistic model for growth.....	250
Can we get some idea of what the relationship between x and y will look like from the differential equation directly, without integrating?.....	254

Slope fields	254
Euler's method.....	258
Miscellaneous exercise ten	260

11

SIMPLE HARMONIC MOTION 264

Revision of rectilinear motion.....	265
A particular type of rectilinear motion: Simple harmonic motion...	269
Solving the differential equation $\ddot{x} = -k^2x$	270
Miscellaneous exercise eleven	279

12

SAMPLE MEANS 282

Sampling	283
Distribution of sample means	284
Increasing the number of samples .	285
Increasing the sample size.....	286
The central limit theorem	289
Sample size	290
Samples with means that are unusually high or unusually low	292
Inferring population parameters from sample statistics.....	296
So do most 95% confidence intervals really contain the population mean? Let's check.....	301
Choosing the sample size	302
Miscellaneous exercise twelve	304

ANSWERS UNIT THREE 311**ANSWERS UNIT FOUR 332****INDEX 341**

IMPORTANT NOTE

This series of texts has been written based on my interpretation of the appropriate *Mathematics Specialist* syllabus documents as they stand at the time of writing. It is likely that as time progresses some points of interpretation will become clarified and perhaps even some changes could be made to the original syllabus. I urge teachers of the *Mathematics Specialist* course, and students following the course, to check with the appropriate curriculum authority to make themselves aware of the latest version of the syllabus current at the time they are studying the course.

Acknowledgements

As with all of my previous books I am again indebted to my wife, Rosemary, for her assistance, encouragement and help at every stage.

To my three beautiful daughters, Rosalyn, Jennifer and Donelle, thank you for the continued understanding you show when I am ‘still doing sums’ and for the love and belief you show.

To the delightfully supportive team at Cengage – I thank you all.

Alan Sadler

Mathematics Specialist

Unit Three



UNIT THREE PRELIMINARY WORK

This book assumes that you are already familiar with a number of mathematical ideas from your mathematical studies in earlier years.

This section outlines the ideas which are of particular relevance to Unit Three of the *Mathematics Specialist* course and for which familiarity will be assumed, or for which the brief explanation given here may be sufficient to bring your understanding of the concept up to the necessary level.

Read this 'Preliminary work' section and if anything is not familiar to you, and you don't understand the brief mention or explanation given here, you may need to do some further reading to bring your understanding of those concepts up to an appropriate level for this unit. (If you do understand the work but feel somewhat 'rusty' with regards to applying the ideas, some of the chapters afford further opportunities for revision, as do some of the questions in the miscellaneous exercises at the end of chapters.)

- Chapters in this book will continue some of the topics from this preliminary work by building on the assumed familiarity with the work.
- The **miscellaneous exercises** that feature at the end of each chapter may include questions requiring an understanding of the topics briefly explained here.
- Much of the content of this preliminary work section is from Units One and Two of the *Mathematics Specialist* course. It is assumed that students embarking on this Unit Three of *Mathematics Specialist* will have successfully completed these two prior units, will also have successfully completed Units One and Two of *Mathematics Methods* and will also be taking Unit Three of *Mathematics Methods*, probably at the same time as studying this unit.

Number

In the real number system, \mathbb{R} , it is assumed that you are familiar with, and competent in the use of, positive and negative numbers, recurring decimals, square roots and cube roots and that you are able to choose levels of accuracy to suit contexts and distinguish between exact values, approximations and estimates.

Numbers expressed with positive, negative and fractional powers should also be familiar to you.

An ability to simplify expressions involving square roots is also assumed.



Shutterstock.com/Stuart Miles

The absolute value

The absolute value of a number is the distance on the number line that the number is from the origin.

The absolute value of x is written $|x|$ and equals x when x is positive,
and equals $-x$ when x is negative.

Thus $|3| = 3$, $|-3| = 3$, $|4| = 4$, $|-4| = 4$.

Just as $|x|$ is the distance x is from the origin, $|x - a|$ tells us the distance x is from the number a .

Function

It is assumed that you are familiar with the idea that in mathematics any rule that takes any input value that it can cope with and assigns to it a one, *and only one*, output value is called a **function**.

Familiarity with the function notation $f(x)$ is also assumed.

It can be useful at times to consider a function as a machine. A box of numbers (the **domain**) is fed into the machine, a certain rule is applied to each number, and the resulting output forms a new box of numbers, the **range**.

In this way $f(x) = x^2 + 3$, with domain $\{1, 2, 3, 4, 5\}$, could be 'pictured' as follows:

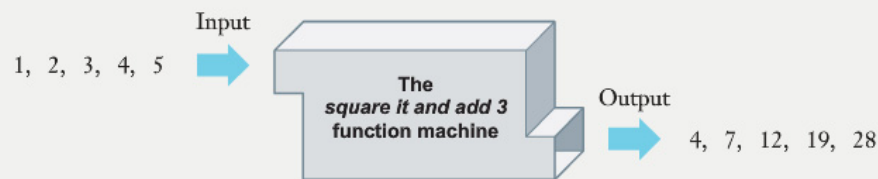

If we are not given a specific domain, we assume it to be all the real numbers that the function can cope with, sometimes referred to as the **natural domain** of the function.

Thus the function $f(x) = \sqrt{x - 3}$ has a domain of all the real numbers greater than or equal to 3, i.e., $\{x \in \mathbb{R}: x \geq 3\}$.

For this domain the function can put out all the real numbers greater than or equal to zero. Thus the range of the function will be all real numbers greater than or equal to 0, i.e., $\{y \in \mathbb{R}: y \geq 0\}$.

It is assumed you are particularly familiar with linear and quadratic functions, their characteristic equations and their graphs, and have some familiarity with the graphs of $y = x^3$, $y = \sqrt{x}$ and $y = \frac{1}{x}$.

It is further assumed that how the graph of $y = af[b(x - c)] + d$ changes as the values of a , b , c and d are altered is something you have previously considered for various functions.

Remember that linear and quadratic functions are members of the larger family of functions called **polynomial functions**. These are functions of the form

$$f(x) = a_n x^n + a_{n-1} x^{n-1} + a_{n-2} x^{n-2} + \dots + a_2 x^2 + a_1 x + a_0$$

where n is a non-negative integer and $a_n, a_{n-1}, a_{n-2}, \dots$ are all numbers, called the **coefficients** of x^n, x^{n-1}, x^{n-2} , etc.

The highest power of x is the **order** of the polynomial.

Thus linear functions, $y = mx + c$, are polynomials of order 1,
 quadratic functions, $y = ax^2 + bx + c$, are polynomials of order 2,
 cubic functions, $y = ax^3 + bx^2 + cx + d$, are polynomials of order 3, etc.

Though not an idea you would necessarily be familiar with, but one that should seem reasonable, is that of using the output from one function as the input of a second function. In this way we form a **composite function**, also referred to as a **function of a function**.

Suppose that $f(x) = x^2$ and $g(x) = x + 3$.

If we feed the set of numbers $\{-3, -2, -1, 0, 1, 2, 3\}$ into f and then feed the output into g what numbers will g output?

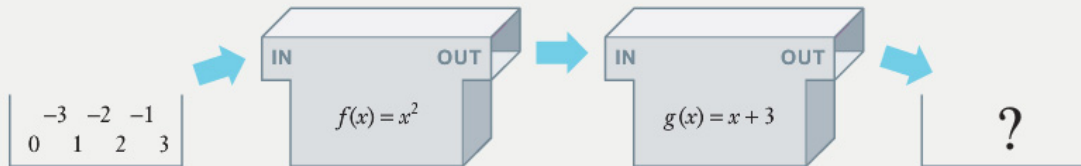

With the domain stated, combining the functions f and g in this way will give a final output of $\{3, 4, 7, 12\}$:

$$\{-3, -2, -1, 0, 1, 2, 3\} \xrightarrow{f(x)} \{0, 1, 4, 9\} \xrightarrow{g(x)} \{3, 4, 7, 12\}$$

We write this combined function as $g[f(x)]$
 or as $g \circ f(x)$ or $g \circ f(x)$ for 'g of f of x'
 or as $gf(x)$.

Note that though our 'machine diagram' above shows the 'f function' first we write the combined function as $gf(x)$. This is to show that the 'f function', being closest to the '(x)', operates on the x values first.

Algebra

It is assumed that you are already familiar with manipulating algebraic expressions, in particular:

- Expanding and simplifying:

For example	$4(x + 3) - 3(x + 2)$	expands to	$4x + 12 - 3x - 6$
		which simplifies to	$x + 6$
	$(x - 7)(x + 1)$	expands to	$x^2 + 1x - 7x - 7$
		which simplifies to	$x^2 - 6x - 7$
	$(2x - 7)^2$, i.e. $(2x - 7)(2x - 7)$	expands to	$4x^2 - 28x + 49$

- Factorising:

For example	$21x + 7$	factorises to	$7(3x + 1)$
	$15apy + 12pyz - 6apq$	factorises to	$3p(5ay + 4yz - 2aq)$
	$x^2 - 6x - 7$	factorises to	$(x - 7)(x + 1)$
	$x^2 - 9$	factorises to	$(x - 3)(x + 3)$

the last one being an example of the *difference of two squares* result:

$$x^2 - y^2 \quad \text{factorises to} \quad (x - y)(x + y)$$

- Solving equations

In particular: linear equations, simultaneous equations, quadratic equations, including use of the formula $x = \frac{-b \pm \sqrt{b^2 - 4ac}}{2a}$, exponential equations (e.g. $2^x + 3 = 35$), trigonometrical equations (e.g. $\sin x = 0.5$ for $0 \leq x \leq 360^\circ$),

and in the use of your calculator to solve equations.

- Completing the square

To express $x^2 - 6x + 10$, for example, in 'completed square form':

create a gap to allow the square of half the coefficient of x to be inserted,

$$\begin{aligned} x^2 - 6x + 10 &= x^2 - 6x + 9 + 10 - 9 \\ \text{insert (and subtract)} &= x^2 - 6x + 9 + 10 - 9 \\ \text{factorise} &= (x - 3)^2 + 1 \end{aligned}$$

- Inequalities

It is assumed that you are familiar with the meaning and use of the symbols $<$, \leq , $>$ and \geq , can solve simple linear inequalities and display the solutions as points on a number line. For example:

Given $5x - 3 < 7$
 $5x < 10$
 $x < 2$

Given $1 - 3x \leq 13$
 $-3x \leq 12$
 $3x \geq -12$
 $x \geq -4$

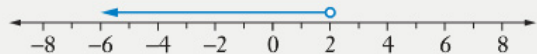

Note especially

- in the example above right, how multiplying by -1 'reverses' the inequality
- the significance of the open and filled circles.

Vectors

Quantities which have magnitude and direction are called **vectors**.

Common examples of vector quantities are:

Displacement, e.g. 5 km south.
 Force, e.g. 6 Newtons upwards.

Velocity, e.g. 5 m/s north.
 Acceleration, e.g. 5 m/s² east.

Quantities which have magnitude only are not vectors. Such quantities are called **scalars**. Common examples of scalar quantities are:

Distance, e.g. 5 km.
 The magnitude of a force, e.g. 6 Newtons.
 The magnitude of the acceleration, e.g. 5 m/s².

Speed, e.g. 5 m/s.
 Energy, e.g. 50 joules.

We represent vector quantities diagrammatically by a line segment in the given direction and whose length represents the magnitude of the vector.

For example, the diagram on the right shows a vector of magnitude 5 units and in direction due east.

We write this vector as \underline{AB} or \overrightarrow{AB} .

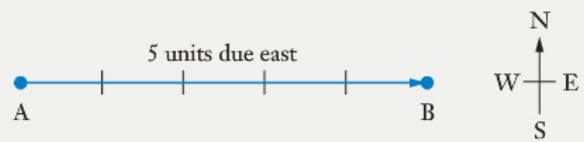

The order of the letters indicates the direction, i.e. **from A to B**.

Vectors are also written using lowercase letters and in such cases bold type or underlining is used.

For the magnitude of vector **a**, we write $|\mathbf{a}|$ or $|\underline{a}|$ or simply a .

Vectors are equal if they have the same magnitude **and** the same direction.

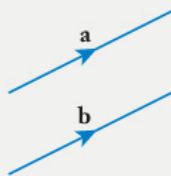
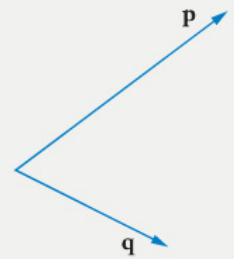

$\mathbf{a} = \mathbf{b}$
Same magnitude,
same direction.

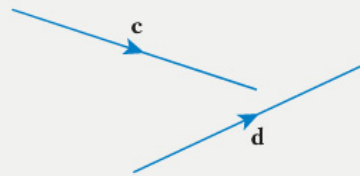

$\mathbf{c} \neq \mathbf{d}$
Same magnitude,
different directions.

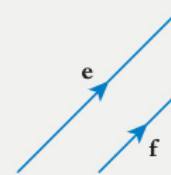

$\mathbf{e} \neq \mathbf{f}$
Same direction,
different magnitudes.

If for some positive scalar k , $\mathbf{b} = k\mathbf{a}$, then **b** is in the same direction as **a** and k times the magnitude. If k is negative then **b** will be in the opposite direction to **a** and $|k|$ times the magnitude.

Two vectors are parallel if one is a scalar multiple of the other.

If the scalar multiple is positive the vectors are said to be *like* parallel vectors, i.e. in the *same* direction.

If the scalar multiple is negative the vectors are said to be *unlike* parallel vectors, i.e. in *opposite* directions.

To add two vectors means to find the single, or **resultant**, vector that could replace the two. We add the vectors using a **vector triangle** in which the two vectors to be added follow 'nose to tail' and form two of the sides of the triangle. The resultant is then the third side of the triangle with its direction 'around the triangle' being in the opposite sense to the other two.

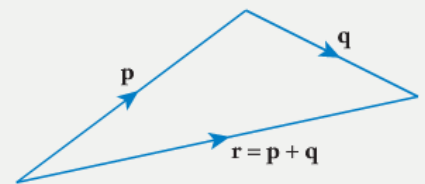

This vector addition is sometimes referred to as the **parallelogram law**.

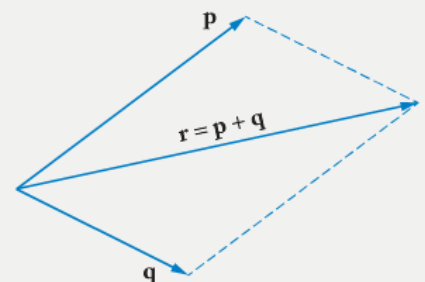

To give meaning to vector subtraction we consider $\mathbf{a} - \mathbf{b}$ as $\mathbf{a} + (-\mathbf{b})$ and then use our technique for adding vectors.

If we add a vector to the negative of itself we obtain the **zero vector**.

The zero vector has zero magnitude and an undefined direction.

Given the vector statement $h\mathbf{a} = k\mathbf{b}$ we can conclude that some scalar multiple of \mathbf{a} has the same magnitude and direction as some scalar multiple of \mathbf{b} . If this is the case then either

\mathbf{a} and \mathbf{b} are parallel (because one is a scalar multiple of the other),

or $h = k = 0$.

Thus if \mathbf{a} and \mathbf{b} are not parallel and we have a vector expression of the form

$$p\mathbf{a} + q\mathbf{b} = r\mathbf{a} + s\mathbf{b} \quad (\text{for scalar } p, q, r \text{ and } s) \quad \leftarrow \text{equation [1]}$$

i.e. $(p - r)\mathbf{a} = (s - q)\mathbf{b}$,

then $p = r$ and $s = q$.

Thus in equation [1], with \mathbf{a} and \mathbf{b} not parallel, we can equate the coefficients of \mathbf{a} , and we can equate the coefficients of \mathbf{b} .

Vectors can be expressed in terms of their **horizontal and vertical components**.

With \mathbf{i} and \mathbf{j} representing unit vectors horizontally and vertically respectively, the vectors \mathbf{a} , \mathbf{b} , \mathbf{c} , \mathbf{d} and \mathbf{e} shown in the diagram can be written:

$$\mathbf{a} = 2\mathbf{j}$$

$$\mathbf{c} = \mathbf{i} + 2\mathbf{j}$$

$$\mathbf{e} = 2\mathbf{i} + \mathbf{j}$$

$$\mathbf{b} = 3\mathbf{i}$$

$$\mathbf{d} = -\mathbf{i} + 2\mathbf{j}$$

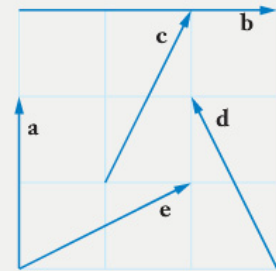

Expressed in this component form the vector arithmetic is straightforward:

$$\begin{aligned} \mathbf{c} + \mathbf{e} &= (\mathbf{i} + 2\mathbf{j}) + (2\mathbf{i} + \mathbf{j}) \\ &= 3\mathbf{i} + 3\mathbf{j} \end{aligned}$$

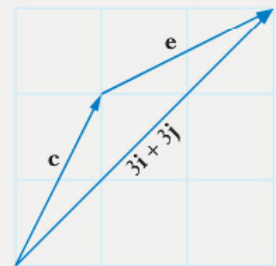

With $\mathbf{p} = a\mathbf{i} + b\mathbf{j}$

the **magnitude**, or **modulus**, of \mathbf{p} is given by

$$|\mathbf{p}| = \sqrt{a^2 + b^2}$$

and θ , see diagram, is found using $\tan \theta = \frac{b}{a}$.

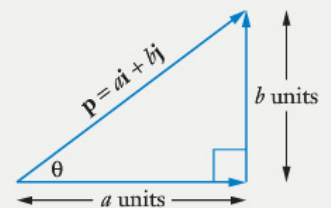

The vector $a\mathbf{i} + b\mathbf{j}$ is sometimes written as an **ordered pair** (a, b) ,
or perhaps $\langle a, b \rangle$,

and sometimes as a **column matrix** $\begin{pmatrix} a \\ b \end{pmatrix}$.

In the diagram on the right \vec{OP} , \vec{AB} and \vec{CD} are each $3\mathbf{i} + \mathbf{j}$. Such vectors are sometimes referred to as **displacement vectors** as they give the *displacement* of P from O, B from A and D from C respectively.

However with O as the origin, only point P has the **position vector** $3\mathbf{i} + \mathbf{j}$.

- Point A has position vector $\mathbf{i} + 2\mathbf{j}$,
- point B has position vector $4\mathbf{i} + 3\mathbf{j}$,
- point C has position vector $4\mathbf{j}$,
- point D has position vector $3\mathbf{i} + 5\mathbf{j}$.

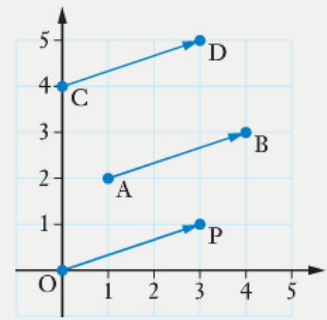

Position vectors give the position of a point relative to the origin. Hence the position vector of point H on the right is $\mathbf{i} + 3\mathbf{j}$.

If instead we want to give the position of H **relative to** point E we write:

$$\begin{aligned} {}_H\mathbf{r}_E &= \vec{EH} \\ &= -3\mathbf{i} + 2\mathbf{j}. \end{aligned}$$

Similarly ${}_G\mathbf{r}_E = -2\mathbf{i} + 3\mathbf{j}, \quad {}_F\mathbf{r}_H = 4\mathbf{i} + \mathbf{j}, \quad {}_E\mathbf{r}_G = 2\mathbf{i} - 3\mathbf{j}.$

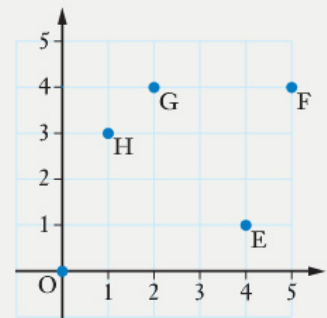

It follows that ${}_P\mathbf{r}_Q = \vec{QP}$
 $= -\mathbf{r}_Q + \mathbf{r}_P$

i.e. ${}_P\mathbf{r}_Q = \mathbf{r}_P - \mathbf{r}_Q$

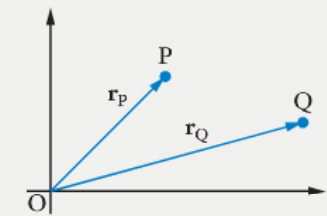

Similarly we can talk of ${}_A\mathbf{v}_B$, the **velocity of A relative to B**. This means the velocity of A as seen by an observer on B.

To view the situation from the point of view of an observer on B we need to imagine a velocity of $-\mathbf{v}_B$ is imposed on the whole system. It will then seem as though B is reduced to rest and the velocity A has in this system ($= \mathbf{v}_A - \mathbf{v}_B$) will equal the velocity of A as seen by an observer on B. i.e. ${}_A\mathbf{v}_B = \mathbf{v}_A - \mathbf{v}_B$.

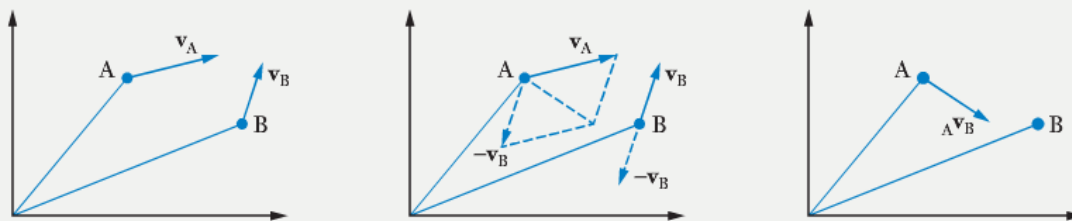

(All velocities are relative to something. When we write \mathbf{v}_A we usually mean the velocity of A relative to the earth.)



We define the **scalar product** of two vectors **a** and **b** to be the magnitude of **a** multiplied by the magnitude of **b** multiplied by the cosine of the angle between **a** and **b**. We write this product as **a.b** and say this as 'a dot b'. For this reason the scalar product is also referred to as the 'dot product'.

Thus $\mathbf{a} \cdot \mathbf{b} = |\mathbf{a}| |\mathbf{b}| \cos \theta$ where θ is the angle between **a** and **b**.

- ' $\mathbf{a} \cos \theta$ ' is the **projection** of **a** onto **b**, or the **resolved part** of **a** in the direction of **b**.

Similarly we can refer to ' $\mathbf{b} \cos \theta$ ' as the projection of **b** onto **a**, or the resolved part of **b** in the direction of **a**.

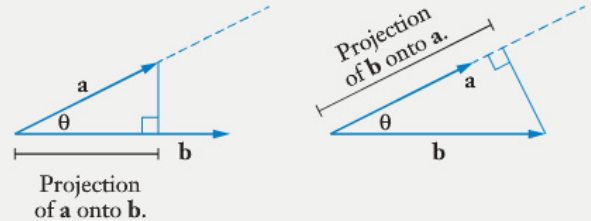

- Remember that the angle between two vectors refers to the angle between the vectors when they are either both directed away from a point or both directed towards it.

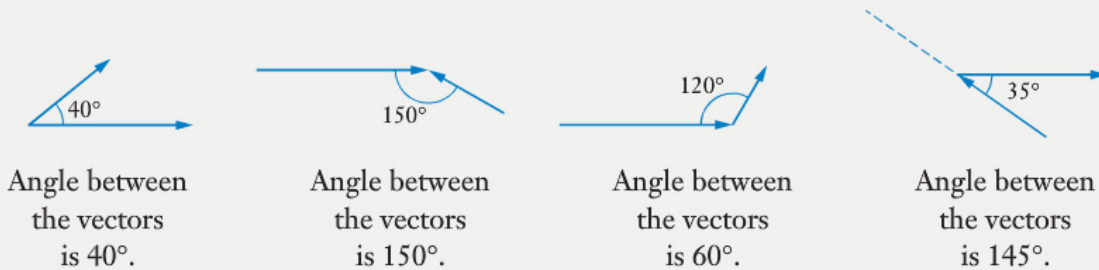

- It follows, from the definition of the scalar product of two vectors, that if **a** and **b** are perpendicular to each other then $\mathbf{a} \cdot \mathbf{b} = 0$.
- It can be shown that the following algebraic properties of the scalar product follow from the definition of $\mathbf{a} \cdot \mathbf{b}$.

$$\begin{aligned} \mathbf{a} \cdot \mathbf{b} &= \mathbf{b} \cdot \mathbf{a} & \mathbf{a} \cdot (\lambda \mathbf{b}) &= (\lambda \mathbf{a}) \cdot \mathbf{b} = \lambda (\mathbf{a} \cdot \mathbf{b}) & \mathbf{a} \cdot \mathbf{a} &= a^2 \\ \mathbf{a} \cdot (\mathbf{b} + \mathbf{c}) &= \mathbf{a} \cdot \mathbf{b} + \mathbf{a} \cdot \mathbf{c} & (\mathbf{a} + \mathbf{b}) \cdot \mathbf{c} &= \mathbf{a} \cdot \mathbf{c} + \mathbf{b} \cdot \mathbf{c} \\ (\mathbf{a} + \mathbf{b}) \cdot (\mathbf{c} + \mathbf{d}) &= \mathbf{a} \cdot \mathbf{c} + \mathbf{a} \cdot \mathbf{d} + \mathbf{b} \cdot \mathbf{c} + \mathbf{b} \cdot \mathbf{d} \end{aligned}$$

- It also follows that:

$$\text{If } \mathbf{a} = x_1 \mathbf{i} + y_1 \mathbf{j} \quad \text{and} \quad \mathbf{b} = x_2 \mathbf{i} + y_2 \mathbf{j} \quad \text{then} \quad \mathbf{a} \cdot \mathbf{b} = x_1 x_2 + y_1 y_2$$

It is assumed that you are familiar with using the above statement to determine the angle between two vectors, given the vectors in component form.

It is assumed that from your previous study of vectors you are familiar with using the above ideas to prove various geometrical results.



Complex numbers

You should be familiar with the idea of a **complex number** as one that is written in the form $a + bi$ (sometimes written $a + ib$) where a and b are real and $i = \sqrt{-1}$.

For some students the first encounter with i representing $\sqrt{-1}$ is when they use their calculator to solve a quadratic equation that has 'no real roots'. For example when solving the quadratic equation

$$x^2 + 6x + 13 = 0.$$

If we attempt to solve this equation using a calculator we may be given a message indicating there are no solutions, or we may be given solutions that involve ' i ', dependent upon whether our calculator is set to solve for real solutions or complex solutions. See the displays below.

solve($x^2 + 6 \cdot x + 13 = 0, x$)
No Solution

solve($x^2 + 6 \cdot x + 13 = 0, x$)
{ $x = -3 - 2 \cdot i, x = -3 + 2 \cdot i$ }

The complex number $a + bi$ consists of a real part and an imaginary part.

For $z = a + bi$ we say that the real part of z is a : $\text{Re}(z) = a$
and the imaginary part of z is b : $\text{Im}(z) = b$.

Thus if $z = 4 + 5i$ then $\text{Re}(z) = 4$
and $\text{Im}(z) = 5$.

Complex numbers can be added to each other, subtracted from each other, multiplied together, divided by each other and multiplied or divided by a real number.

This is demonstrated below, and on the next page, for $w = 2 + 3i$ and $z = 5 - 4i$. Note that in each case the answer is given in the form $a + bi$ and especially note how this is achieved when one complex number is divided by another on the next page.

$$\begin{aligned}w + z &= (2 + 3i) + (5 - 4i) \\ &= 7 - i\end{aligned}$$

$$\begin{aligned}w - z &= (2 + 3i) - (5 - 4i) \\ &= 2 + 3i - 5 + 4i \\ &= -3 + 7i\end{aligned}$$

$$\begin{aligned}3w - 2z &= 3(2 + 3i) - 2(5 - 4i) \\ &= 6 + 9i - 10 + 8i \\ &= -4 + 17i\end{aligned}$$

$$\begin{aligned}wz &= (2 + 3i)(5 - 4i) \\ &= 10 - 8i + 15i - 12i^2 \\ &= 10 - 8i + 15i + 12 \\ &= 22 + 7i\end{aligned}$$

$$\begin{aligned}
z^2 &= (5 - 4i)(5 - 4i) \\
&= 25 - 20i - 20i + 16i^2 \\
&= 25 - 20i - 20i - 16 \\
&= 9 - 40i
\end{aligned}
\qquad
\begin{aligned}
\frac{w}{z} &= \frac{(2 + 3i)}{(5 - 4i)} \\
\therefore \frac{w}{z} &= \frac{(2 + 3i)(5 + 4i)}{(5 - 4i)(5 + 4i)} \\
&= \frac{10 + 8i + 15i + 12i^2}{25 + 20i - 20i - 16i^2} \\
&= \frac{-2 + 23i}{41} \\
&= -\frac{2}{41} + \frac{23}{41}i
\end{aligned}$$

Alternatively these answers can be obtained from a calculator.

If $z = a + bi$ we say that $a - bi$ is the **conjugate** of z (also referred to as the **complex conjugate** of z). We use the symbol \bar{z} for the conjugate of z .

Thus,

if	$z = 2 + 3i$	then	$\bar{z} = 2 - 3i,$	
	$z = 5 - 7i$		$\bar{z} = 5 + 7i,$	
	$z = -2 + 8i$		$\bar{z} = -2 - 8i,$	
	$z = -3 - 4i$		$\bar{z} = -3 + 4i,$	etc.

For any complex number $z (= a + bi)$, both the sum

$$\begin{aligned}
z + \bar{z} &= (a + bi) + (a - bi) \\
&= 2a
\end{aligned}$$

and the product

$$\begin{aligned}
z\bar{z} &= (a + bi)(a - bi) \\
&= a^2 + b^2
\end{aligned}$$

are real.

(The fact that the product $z\bar{z}$ is real was used to produce a real denominator when $\frac{w}{z}$ was formed earlier on this page.)

If two complex numbers, w and z , are equal then

$$\operatorname{Re}(w) = \operatorname{Re}(z) \qquad \text{and} \qquad \operatorname{Im}(w) = \operatorname{Im}(z).$$

If we write the complex number $a + bi$ as an **ordered pair** (a, b) this can be used like coordinates to represent the complex number as a point on a graph. Instead of x and y axes we have real and imaginary axes. Such a graphical representation is called an **Argand diagram** and the plane containing the real and imaginary axes is referred to as the **complex plane**. The complex number $a + bi$ can be thought of as the point (a, b) on the Argand diagram or as the vector from the origin to the point (a, b) .



The Argand diagram on the right shows the complex numbers

$$z_1 = 6 + 4i,$$

$$z_2 = -7 + 6i,$$

$$z_3 = -6 - 3i,$$

and $z_4 = 4 - 3i.$

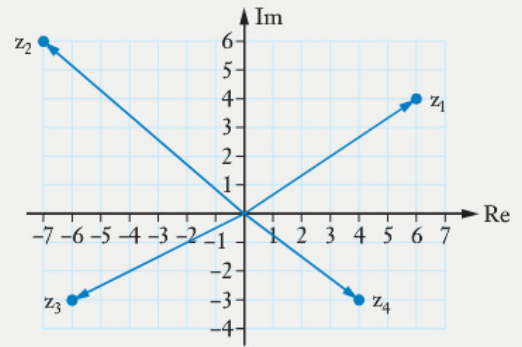

Notice that we can then add complex numbers in the complex plane using the ‘nose to tail’ method of vector addition.

$$\begin{aligned} z_2 + z_3 &= (-7 + 6i) + (-6 - 3i) \\ &= -13 + 3i \end{aligned}$$

$$\begin{aligned} z_1 + z_4 &= (6 + 4i) + (4 - 3i) \\ &= 10 + i \end{aligned}$$

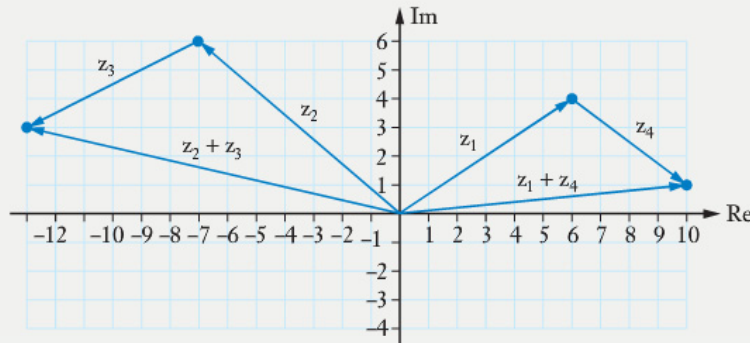

Circles

The reader is reminded of the following:

$$\begin{aligned} x^2 + y^2 &= r^2 && \text{is the equation of a circle centre } (0, 0) \text{ and radius } r, \\ (x - p)^2 + (y - q)^2 &= r^2 && \text{is the equation of a circle centre } (p, q) \text{ and radius } r. \end{aligned}$$

Given the equation:

$$x^2 + y^2 + 6y = 10x$$

Create gaps

$$x^2 - 10x + \dots + y^2 + 6y + \dots = 0$$

Complete the squares

$$x^2 - 10x + 25 + y^2 + 6y + 9 = 0 + 25 + 9$$

i.e.

$$(x - 5)^2 + (y + 3)^2 = 34$$

Thus $x^2 + y^2 + 6y = 10x$ is the equation of circle, centre $(5, -3)$ and radius $\sqrt{34}$.

By way of practice confirm that the equation $2x^2 + x + 2y^2 - 5y = 3$ is that of a circle centre $(-0.25, 1.25)$ and radius $\frac{5\sqrt{2}}{4}$. (Hint: Divide through by 2 first.)

Differentiation

It is assumed that you are familiar with the idea of the **gradient**, or *slope*, of a line and, in particular, that whilst a straight line has the same gradient everywhere, the gradient of a curve varies as we move along the curve.

To find the gradient at a particular point, P, on a curve $y = f(x)$ we choose some other point, Q, on the curve whose x -coordinate is a little more than that of point P.

Suppose P has an x -coordinate of x and Q has an x -coordinate of $(x + h)$.

The corresponding y -coordinates of P and Q will then be $f(x)$ and $f(x + h)$.

Thus the gradient of PQ = $\frac{f(x + h) - f(x)}{h}$.

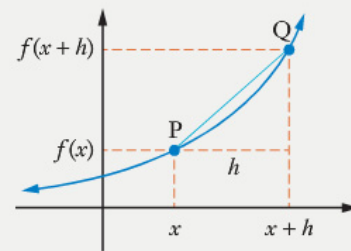

We then bring Q closer and closer to P, i.e. we allow h to tend to zero, and we determine the limiting value of the gradient of PQ.

i.e. Gradient at P = limit of $\frac{f(x + h) - f(x)}{h}$ as h tends to zero.

This gives us the **instantaneous rate of change** of the function at P.

The process of determining the **gradient formula** or **gradient function** of a curve is called **differentiation**.

Writing h , the small increase, or *increment*, in the x coordinate, as δx , where 'δ' is a Greek letter pronounced 'delta', and $f(x + h) - f(x)$, the small increment in the y coordinate as δy , we have:

$$\text{Gradient function} = \lim_{\delta x \rightarrow 0} \frac{\delta y}{\delta x}$$

This **derivative** is written as $\frac{dy}{dx}$ and pronounced 'dee y by dee x '.

This 'limiting chord process' gives the following results:

$$\text{If } y = x^2 \quad \text{then } \frac{dy}{dx} = 2x.$$

$$\text{If } y = x^3 \quad \text{then } \frac{dy}{dx} = 3x^2.$$

$$\text{If } y = x^4 \quad \text{then } \frac{dy}{dx} = 4x^3.$$

$$\text{If } y = x^5 \quad \text{then } \frac{dy}{dx} = 5x^4.$$

The general statement is:

$$\text{If } y = ax^n \quad \text{then } \frac{dy}{dx} = anx^{n-1}.$$

You should also be familiar with the following points:

- If $y = f(x)$ then the derivative of y with respect to x can be written as $\frac{dy}{dx}$, $\frac{df}{dx}$ or $\frac{d}{dx} f(x)$.
- A shorthand notation using a 'dash' may be used for differentiation with respect to x . Thus if $y = f(x)$ we can write $\frac{dy}{dx}$ as $f'(x)$ or simply y' or f' .
- If $y = f(x) \pm g(x)$ then $\frac{dy}{dx} = f'(x) \pm g'(x)$.

Whenever we are faced with the task of finding the gradient formula, gradient function or derivative of some 'new' function, for which we do not already have a rule, for example if we wanted to determine the gradient function for $y = \sin x$, we simply go back to the basic principle:

$$\text{Gradient at } P(x, f(x)) = \lim_{h \rightarrow 0} \frac{f(x+h) - f(x)}{h}$$

Sketching graphs

The use of differentiation to determine the gradient function of a curve can give useful information about the nature of the graph and assist us in making a **sketch** of the graph. Whilst we would not expect to be able to read values from the sketch of a graph with any great accuracy, the sketch should still be neatly drawn and should show the noteworthy features of the graph. In relation to graph sketching it is assumed that you are already familiar with, and understand, the following terms:

Turning points.

Stationary points.

Local and global maxima and minima.

Horizontal, and non-horizontal, points of inflection.

Intercepts with the axes.

Asymptotes.

Concavity.

Symmetry.

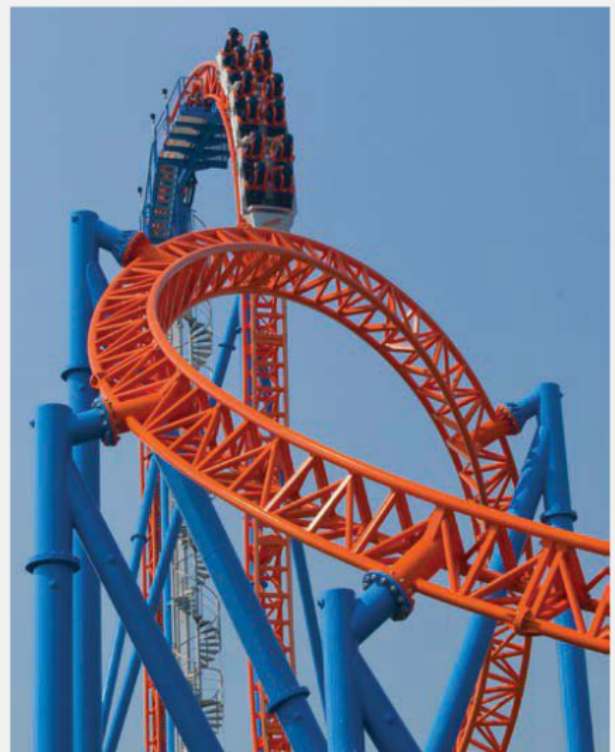

Shutterstock.com/aslostepic

Antidifferentiation

Antidifferentiation is, as its name suggests, the opposite of differentiation.

Given the **derivative**, or **gradient function**, $\frac{dy}{dx}$, antidifferentiation returns us to the function, or **primitive**.

However there are a many functions that differentiate to $2x$, for example:

$$\text{If } y = x^2 \quad \text{then } \frac{dy}{dx} = 2x.$$

$$\text{If } y = x^2 + 1 \quad \text{then } \frac{dy}{dx} = 2x.$$

$$\text{If } y = x^2 - 3 \quad \text{then } \frac{dy}{dx} = 2x. \quad \text{Etc.}$$

Thus we say that the antiderivative of $2x$ is $x^2 + c$ where c is some constant. Given further information it may be possible to determine the value of this constant.

The general statement is:

$$\text{If } \frac{dy}{dx} = ax^n \quad \text{then } y = \frac{ax^{n+1}}{n+1} + c$$

Remembered as: '*Increase the power by one and divide by the new power.*'

(Clearly this rule cannot apply for $n = -1$. Such a situation is beyond the scope of this unit.)

$$\begin{aligned} \text{Hence the antiderivative of } 6x^2 + 7 \quad \text{is} \quad & \frac{6x^3}{3} + \frac{7x^1}{1} + c \\ \text{i.e.} \quad & 2x^3 + 7x + c \end{aligned}$$

It is also assumed that you are familiar with the fact that antidifferentiation is also known as **integration**. Instead of being asked to find the antiderivative of $6x^2 + 7$ we could be asked to **integrate** $6x^2 + 7$.

Integration uses the symbol \int .

$$\begin{aligned} \text{Hence the fact that the antiderivative of } 6x^2 + 7 \quad \text{is} \quad & 2x^3 + 7x + c \\ \text{could be written as} \quad & \int (6x^2 + 7) dx = 2x^3 + 7x + c \end{aligned}$$

the ' dx ' indicating that the antidifferentiation, or integration, is with respect to the variable x .

Our general rule for antidifferentiating ax^n could then be written:

$$\int ax^n dx = \frac{ax^{n+1}}{n+1} + c$$

Trigonometrical identities

It is assumed that you are already familiar with the following trigonometrical identities:

$$\sin^2 \theta + \cos^2 \theta = 1 \quad (\text{Pythagorean identity.})$$

(Sometimes referred to as the first of the Pythagorean identities.)

$$\sin(A \pm B) = \sin A \cos B \pm \cos A \sin B$$

$$\cos(A \pm B) = \cos A \cos B \mp \sin A \sin B$$

(From which $\sin 2A = 2 \sin A \cos A$ and $\cos 2A = \cos^2 A - \sin^2 A$.)

It is also assumed that you are familiar with the fact that the reciprocals of $\sin \theta$, $\cos \theta$ and $\tan \theta$,

i.e. $\frac{1}{\sin \theta}$, $\frac{1}{\cos \theta}$ and $\frac{1}{\tan \theta}$ are given names of their own.

$$\frac{1}{\cos \theta} = \sec \theta \quad \frac{1}{\sin \theta} = \operatorname{cosec} \theta \quad \frac{1}{\tan \theta} = \cot \theta \quad \left(= \frac{\cos \theta}{\sin \theta} \right)$$

\sec , cosec and \cot being abbreviations for secant, cosecant and cotangent.

Pythagorean identities can be established for these reciprocal functions:

$$\tan^2 \theta + 1 = \sec^2 \theta$$

$$1 + \cot^2 \theta = \operatorname{cosec}^2 \theta$$

Matrices

It is assumed that you are familiar with the 'rows and columns' presentation of information called a **matrix**.

Whilst the following ideas should all be familiar to you:

the size of a matrix,
a row matrix,
a column matrix,
equal matrices,
addition and subtraction of matrices,
multiplication of a matrix by a scalar,
multiplication of a matrix by a matrix,
square matrices,
the leading diagonal of a square matrix,
multiplicative identity matrices,
and the inverse of a 2×2 matrix,

and

for this unit, two ideas of particular relevance are:

the determinant of a 2×2 matrix
and solving simultaneous equations by matrix methods.

You are reminded of these two ideas on the next page.

- For the 2×2 matrix $A = \begin{bmatrix} a & b \\ c & d \end{bmatrix}$ the quantity $(ad - bc)$ is the **determinant** of A .
- To solve the simultaneous equations $\begin{cases} x - y = 7 \\ 2x + 3y = 4 \end{cases}$

First write the equations in matrix form: $\begin{bmatrix} 1 & -1 \\ 2 & 3 \end{bmatrix} \begin{bmatrix} x \\ y \end{bmatrix} = \begin{bmatrix} 7 \\ 4 \end{bmatrix}$.

Then use the multiplicative inverse of $\begin{bmatrix} 1 & -1 \\ 2 & 3 \end{bmatrix}$, i.e. $\frac{1}{5} \begin{bmatrix} 3 & 1 \\ -2 & 1 \end{bmatrix}$, as shown below.

Given $\begin{bmatrix} 1 & -1 \\ 2 & 3 \end{bmatrix} \begin{bmatrix} x \\ y \end{bmatrix} = \begin{bmatrix} 7 \\ 4 \end{bmatrix}$

It follows that $\frac{1}{5} \begin{bmatrix} 3 & 1 \\ -2 & 1 \end{bmatrix} \begin{bmatrix} 1 & -1 \\ 2 & 3 \end{bmatrix} \begin{bmatrix} x \\ y \end{bmatrix} = \frac{1}{5} \begin{bmatrix} 3 & 1 \\ -2 & 1 \end{bmatrix} \begin{bmatrix} 7 \\ 4 \end{bmatrix}$

Hence $\begin{bmatrix} 1 & 0 \\ 0 & 1 \end{bmatrix} \begin{bmatrix} x \\ y \end{bmatrix} = \frac{1}{5} \begin{bmatrix} 3 & 1 \\ -2 & 1 \end{bmatrix} \begin{bmatrix} 7 \\ 4 \end{bmatrix}$

$$\begin{bmatrix} x \\ y \end{bmatrix} = \frac{1}{5} \begin{bmatrix} 3 & 1 \\ -2 & 1 \end{bmatrix} \begin{bmatrix} 7 \\ 4 \end{bmatrix}$$

$$= \frac{1}{5} \begin{bmatrix} 25 \\ -10 \end{bmatrix}$$

Thus, $x = 5$ and $y = -2$.

Use of technology

You are encouraged to use your calculator, computer programs and the internet whenever appropriate during this unit.

However you should make sure that you can also perform the basic processes without the assistance of such technology when required to do so.

Note: The illustrations of calculator displays shown in the book may not exactly match the display from your calculator. The illustrations are not meant to show you exactly what your calculator will necessarily display but are included more to inform you that at that moment the use of a calculator could well be appropriate.



Complex numbers, a reminder

- A reminder
- Algebraic fractions
- The remainder theorem
- The factor theorem
- Miscellaneous exercise one

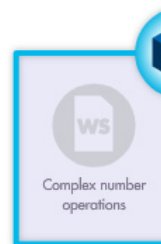

A reminder

As the title suggests, this chapter serves as a reminder of the complex number work you are likely to have covered in earlier units, and that was mentioned in the complex number part of the *Preliminary work* section. However, as we will see later, the chapter also introduces two further ideas, namely the factor theorem and the remainder theorem. Before considering these theorems, first allow the chapter to serve its 'reminder purpose' and work through the following exercise involving complex numbers.

Exercise 1A

1 Write each of the following in the form ai where a is real and $i = \sqrt{-1}$.

a $\sqrt{-64}$ **b** $\sqrt{-8}$ **c** $\sqrt{-10}$ **d** $\sqrt{-63}$

2 For the complex number $z = -5 + 3i$ state

a $\text{Re}(z)$ **b** $\text{Im}(z)$

3 For the complex number $z = 12 - 5i$ state

a $\text{Re}(z)$ **b** $\text{Im}(z)$

4 Use the fact that if $ax^2 + bx + c = 0$ then $x = \frac{-b \pm \sqrt{b^2 - 4ac}}{2a}$ to determine the *exact* solutions of the following quadratic equations, giving your answers in the form $d + ei$ where d and e are real numbers and $i = \sqrt{-1}$.

a $x^2 - 3x + 3 = 0$

b $x^2 + 4x + 7 = 0$

c $3x^2 - x + 1 = 0$

d $5x^2 + 8x + 4 = 0$

Simplify each of the following expressions.

5 $(3 + 7i) + (2 - i)$

6 $(1 - 2i) - (3 - 2i)$

7 $12 + 4i - 2 - 5i$

8 $6 - i + 3 + 4i$

9 $(1 + i) + (3 - 2i) + (4 - i)$

10 $2(5 - 2i) + 2(-5 + 3i)$

11 $7(1 - 3i) + 15i$

12 $5 + 3(4 + 2i)$

13 $\text{Re}(5 + 2i) + \text{Re}(-3 + 4i)$

14 $\text{Im}(-1 - 7i) + \text{Im}(3 + 2i)$

15 $(5 - 2i)(2 + 3i)$

16 $(3 + i)(3 + 2i)$

17 $(2 + i)(2 - i)$

18 $(-2 + 7i)(7 - 2i)$

Express each of the following in the form $a + bi$ where a and b are real numbers.

19 $\frac{2-3i}{1+2i}$

20 $\frac{2-3i}{2+3i}$

21 $\frac{5-2i}{3+4i}$

22 $\frac{i}{2-i}$

23 If $w = 2 + 3i$ and $z = 5 - i$ determine exactly

a $w + z$

b $w - z$

c $5w - 4z$

d wz

e z^2

f $\frac{w}{z}$

24 If $z = 4 - 7i$ and \bar{z} is the complex conjugate of z determine

a \bar{z}

b $z + \bar{z}$

c $z\bar{z}$

d $\frac{z}{\bar{z}}$

25 Given that: $z = 5 + ai$,
 $w = b - 34i$,
 a and b are real numbers,
and $z = w$,
determine a and b .

26 If $(a + 5i)(2 - i) = b$ where a and b are real numbers, determine a and b .

27 a Use the quadratic formula to prove that if a quadratic equation has any non-real roots then it must have two and they must be conjugates of each other.

b One root of $x^2 + px + q = 0$, for p and q real, is $x = 2 + 3i$. Find p and q .

c One root of $x^2 + dx + e = 0$, for d and e real, is $x = 3 - 2i$. Find d and e .

28 First note the following statements:

- The complex number $a + bi$ can be expressed as the 'ordered pair' (a, b) .
- Each of the parts of this question use this ordered pair representation of a complex number.

Simplify the following, giving answers in ordered pair form.

a $(5, 1) + (-3, 2)$

b $(-2, 3) - (1, 3)$

c $(2, 0) \times (2, 1)$

d $(5, -1) \div (-5, 12)$

29 Find all possible real number pairs a, b such that $\frac{14-5i}{a-4i} = 2 + bi$.

Algebraic fractions

If a fraction has polynomial expressions for both numerator and denominator the fraction may be either 'proper' or 'improper'.

Proper algebraic fractions have the order of the numerator (the top of the fraction) less than the order of the denominator (the bottom of the fraction).

For example: $\frac{x}{x^2 + 3}$, $\frac{x^2 + 3x + 4}{x^3 + 2x + 1}$, $\frac{x^3 + 6x^2 + 2x + 1}{x^5 - 6}$

Improper algebraic fractions have the order of the numerator equal to or greater than the order of the denominator.

For example: $\frac{x^2 + 3x + 4}{x + 4}$, $\frac{x^3 + 7x^2 + 5x - 1}{x - 3}$, $\frac{x^2 + 3x + 4}{x^2 - 2x + 1}$, $\frac{x^3 + 6x^2 + 1}{x^2 + 3x - 2}$

Improper algebraic fractions can, with a bit of 'algebraic juggling', be rearranged to an expression involving a proper fraction.

For example:
$$\begin{aligned}\frac{x^2 + 3x + 4}{x + 4} &= \frac{x(x + 4) - x + 4}{x + 4} \\ &= \frac{x(x + 4) - (x + 4) + 8}{x + 4} \\ &= x - 1 + \frac{8}{x + 4}\end{aligned}$$

We could say that $(x + 4)$, goes into $x^2 + 3x + 4$, $(x - 1)$ times, with a remainder of 8 still left over the $x + 4$.

$$\begin{aligned}\frac{x^3 + 7x^2 + 5x - 1}{x - 3} &= \frac{x^2(x - 3) + 10x^2 + 5x - 1}{x - 3} \\ &= \frac{x^2(x - 3) + 10x(x - 3) + 35x - 1}{x - 3} \\ &= \frac{x^2(x - 3) + 10x(x - 3) + 35(x - 3) + 104}{x - 3} \\ &= x^2 + 10x + 35 + \frac{104}{x - 3}\end{aligned}$$

We could say that $(x - 3)$, goes into $x^3 + 7x^2 + 5x - 1$, $(x^2 + 10x + 35)$ times, with a remainder of 104 still left over the $x - 3$.



The remainder theorem

If a polynomial, $f(x)$, is divided by $(x - a)$ until the remainder is a constant (i.e. does not involve x), then this remainder is $f(a)$. This is the **remainder theorem**.

Suppose $f(x) = x^2 + 3x + 4$.

According to the remainder theorem, if we divide $x^2 + 3x + 4$ by $(x + 4)$, i.e. $(x - (-4))$, we should find that the remainder is $f(-4)$.

$$\begin{aligned}\text{Now if} \quad f(x) &= x^2 + 3x + 4 \\ f(-4) &= (-4)^2 + 3(-4) + 4 \\ &= 16 - 12 + 4 \\ &= 8\end{aligned}$$

This is indeed the remainder we obtained when we divided $x^2 + 3x + 4$ by $(x + 4)$ on the previous page.

Suppose $f(x) = x^3 + 7x^2 + 5x - 1$.

According to the remainder theorem, if we divide $x^3 + 7x^2 + 5x - 1$ by $(x - 3)$, we should find that the remainder is $f(3)$.

$$\begin{aligned}\text{Now if} \quad f(x) &= x^3 + 7x^2 + 5x - 1 \\ f(3) &= (3)^3 + 7(3)^2 + 5(3) - 1 \\ &= 27 + 63 + 15 - 1 \\ &= 104\end{aligned}$$

Again this is the remainder we obtained when we divided $x^3 + 7x^2 + 5x - 1$ by $(x - 3)$ on the previous page.

To prove the remainder theorem we express the polynomial $f(x)$ as the product of $(x - a)$ and some suitable chosen polynomial $g(x)$, with some suitable chosen constant k added,

$$\text{i.e.} \quad f(x) = g(x)(x - a) + k.$$

Then, dividing $f(x)$ by $(x - a)$ will leave a remainder of k .

$$\begin{aligned}\text{However, if we substitute } x = a \text{ into} \quad f(x) &= g(x)(x - a) + k \\ \text{we obtain} \quad f(a) &= g(a)(a - a) + k \\ \text{i.e.} \quad f(a) &= k\end{aligned}$$

Hence the remainder, k , is equal to $f(a)$, as required.

The factor theorem

From the remainder theorem it follows that for the polynomial $f(x)$, if $f(a) = 0$ then dividing $f(x)$ by $(x - a)$ leaves no remainder, i.e. $(x - a)$ must be a factor of $f(x)$.

Remembering some of the logic symbols encountered in Unit One of the *Mathematics Specialist* course we can write:

$$\begin{aligned}\text{If } f(a) = 0 \text{ then } (x - a) \text{ is a factor of } f(x): \quad f(a) = 0 &\Rightarrow (x - a) \text{ is a factor of } f(x). \\ \text{If } (x - a) \text{ is a factor of } f(x) \text{ then } f(a) = 0: \quad (x - a) \text{ is a factor of } f(x) &\Rightarrow f(a) = 0. \\ f(a) = 0 &\Leftrightarrow (x - a) \text{ is a factor of } f(x).\end{aligned}$$

This is the **factor theorem**.

EXAMPLE 1

- a** For $f(x) = x^4 - 6x^3 + 10x^2 + 2x - 15$ determine $f(1)$, $f(-1)$, $f(3)$ and $f(-3)$.
- b** Without using the solve facility of some calculators, solve the following equation.

$$x^4 - 6x^3 + 10x^2 + 2x - 15 = 0$$

Solution

a If

$$f(x) = x^4 - 6x^3 + 10x^2 + 2x - 15$$

$$f(1) = (1)^4 - 6(1)^3 + 10(1)^2 + 2(1) - 15$$

$$= 1 - 6 + 10 + 2 - 15$$

$$= -8$$

$$f(-1) = (-1)^4 - 6(-1)^3 + 10(-1)^2 + 2(-1) - 15$$

$$= 1 + 6 + 10 - 2 - 15$$

$$= 0$$

$$f(3) = (3)^4 - 6(3)^3 + 10(3)^2 + 2(3) - 15$$

$$= 81 - 162 + 90 + 6 - 15$$

$$= 0$$

$$f(-3) = (-3)^4 - 6(-3)^3 + 10(-3)^2 + 2(-3) - 15$$

$$= 81 + 162 + 90 - 6 - 15$$

$$= 312$$

Hence, $f(1) = -8$, $f(-1) = 0$, $f(3) = 0$ and $f(-3) = 312$.

- b** With $f(-1) = 0$ and $f(3) = 0$ we know that $(x + 1)$ and $(x - 3)$ are factors of $f(x)$.

$$\therefore f(x) = x^4 - 6x^3 + 10x^2 + 2x - 15$$

$$= (x + 1)(x - 3)(ax^2 + bx + c)$$

By inspection (consider the x^4 term and the constant term, -15), $a = 1$ and $c = 5$.

$$\therefore f(x) = (x + 1)(x - 3)(x^2 + bx + 5)$$

$$= (x^2 - 2x - 3)(x^2 + bx + 5)$$

Were we to expand the above expression the coefficient of x^2 would be $(5 - 2b - 3)$.

Thus $5 - 2b - 3 = 10$

Giving $b = -4$

Hence $f(x) = (x + 1)(x - 3)(x^2 - 4x + 5)$

Thus if $x^4 - 6x^3 + 10x^2 + 2x - 15 = 0$

$$(x + 1)(x - 3)(x^2 - 4x + 5) = 0$$

$$x + 1 = 0$$

$$x = -1$$

$$x - 3 = 0$$

$$x = 3$$

or $x^2 - 4x + 5 = 0$

$$x = \frac{4 \pm \sqrt{16 - 4(1)(5)}}{2}$$

$$= 2 \pm i$$

The required solutions are $x = -1$, $x = 3$, $x = 2 + i$, $x = 2 - i$.



Exercise 1B

(In this exercise, when asked to solve an equation, give both real and complex solutions.)

- 1** Given that $(x - 1)$ is a factor of $2x^3 + x^2 + px + 35$, determine p .
- 2** Given that $x^3 + 3x^2 - 2x - 16 = (x - a)(bx^2 + cx + d)$, determine a, b, c and d (all $\in \mathbb{R}$).
- 3 a** Using the ‘algebraic juggling’ approach demonstrated on an earlier page, determine the remainder when $x^2 - 7x + 3$ is divided by $(x - 1)$.
b Use the remainder theorem to confirm your answer for part **a**.
- 4 a** Using the ‘algebraic juggling’ approach demonstrated on an earlier page, determine the remainder when $2x^3 + 3x^2 - 4x + 3$ is divided by $(x + 1)$.
b Use the remainder theorem to confirm your answer for part **a**.
- 5** Find the remainder when $x^2 + 3x - 6$ is divided by $(x - 2)$.
- 6** Find the remainder when $x^3 - 5x^2 - 8x + 7$ is divided by $(x + 2)$.
- 7** The function $f(x) = 2x^3 + ax^2 + bx - 2$ has $(2x - 1)$ as a factor but a remainder of -6 is left when $f(x)$ is divided by $(x + 1)$. Find a and b .
- 8 a** For $f(x) = x^3 - 3x^2 + 7x - 5$ determine $f(-1)$ and $f(1)$.
b *Without* using the solve facility of some calculators, solve the equation:
$$x^3 - 3x^2 + 7x - 5 = 0$$

c *Without* using the solve facility of some calculators, solve the equation:
$$x^4 - 3x^3 + 7x^2 - 5x = 0$$
- 9 a** For $f(x) = x^4 - 5x^3 - x^2 + 11x - 30$ determine $f(-2), f(2), f(-5)$ and $f(5)$.
b *Without* using the solve facility of some calculators, solve the equation:
$$x^4 - 5x^3 - x^2 + 11x - 30 = 0$$
- 10 a** For $f(x) = 2x^3 - x^2 + 2x - 1$ determine $f(1)$ and $f(0.5)$.
b *Without* using the solve facility of some calculators, solve the equation:
$$2x^3 - x^2 + 2x - 1 = 0$$
- 11** *Without* using the solve facility of some calculators, solve the equation:
$$(x^2 + 2x + 2)(x^2 - 2x + 5) = 0$$
- 12** *Without* using the solve facility of some calculators, solve the equation:
$$2x^3 - 3x^2 + 9x - 8 = 0$$
- 13** *Without* using the solve facility of some calculators, solve the equation:
$$3x^4 - 3x^3 - 2x^2 + 4x = 0$$

Miscellaneous exercise one

This miscellaneous exercise may include questions involving the work of this chapter and the ideas mentioned in the Preliminary work section at the beginning of the book.

1 Simplify each of the following.

a $(7 + 3i)(7 - 3i)$

b $(5 + i)(5 - i)$

c $(3 + 2i)(2 - 3i)$

d $(1 - 5i)^2$

e $\frac{3 - 2i}{2 + i}$

f $\frac{1 + 2i}{3 - 4i}$

2 Given that $z = 3 - 4i$ and $w = -4 + 5i$ determine

a $z + w$

b zw

c \bar{z} , the conjugate of z

d z^2

e $\overline{z\bar{w}}$

f $\bar{z}\bar{w}$

g the complex number q such that $\operatorname{Re}(q) = \operatorname{Re}(\bar{w})$
and $\operatorname{Im}(q) = \operatorname{Im}(\bar{z})$.

3 Express $(1 + i)^5$ in the form $a + bi$.

4 Determine $\operatorname{Im}[(1 - 3i)^3]$.

5 Find:

a $\operatorname{Re}(3 - 2i) \times \operatorname{Re}(2 + i)$

b $\operatorname{Re}[(3 - 2i) \times (2 + i)]$

6 Given that $(x - 5)$ is a factor of $x^4 + qx^3 - 14x^2 - 45x - 50$, determine q .

7 Given that $2x^3 - x^2 + 3x + 6 = (x - a)(bx^2 + cx + d)$, determine a, b, c and d (all real).

8 The function $f(x) = x^4 + 3x^3 + px^2 + qx - 30$ has $(x - 3)$ as a factor but a remainder of -48 is left when $f(x)$ is divided by $(x - 1)$. Find p and q .

9 If $\mathbf{a} = 3\mathbf{i} - \mathbf{j}$, $\mathbf{b} = 2\mathbf{i} + 4\mathbf{j}$ and $\mathbf{c} = d\mathbf{i} - 9\mathbf{j}$.

Find

a a vector in the same direction as \mathbf{a} but twice the magnitude of \mathbf{a} ,

b a vector in the same direction as \mathbf{b} but equal in magnitude to \mathbf{a} ,

c the possible values of d if \mathbf{c} has the same magnitude as $3\mathbf{a}$,

d $\mathbf{a} \cdot \mathbf{b}$

e the angle between \mathbf{a} and \mathbf{b} , to the nearest degree.

10 With \mathbf{a} as defined in the diagram below, express each of the vectors \mathbf{b} , \mathbf{c} , \mathbf{d} , \mathbf{e} , \mathbf{f} and \mathbf{g} in terms of \mathbf{a} .

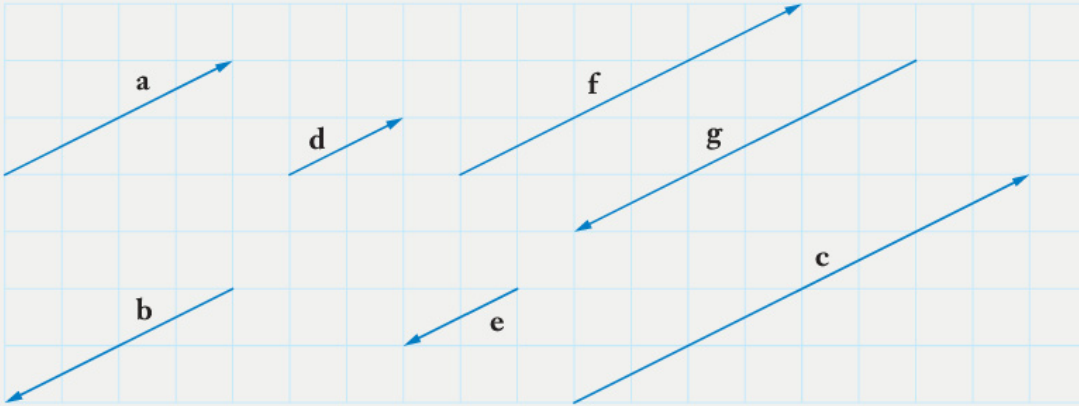

11 With \mathbf{p} and \mathbf{q} as defined in the diagram below, express each of the vectors \mathbf{r} , \mathbf{s} , \mathbf{t} and \mathbf{u} in terms of \mathbf{p} and \mathbf{q} .

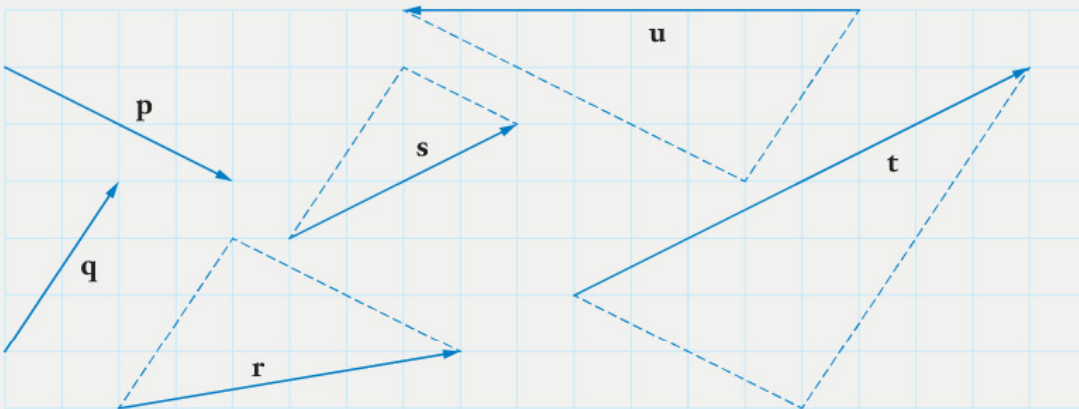

12 *Without* using the solve facility of some calculators, solve the equation

$$x^3 + 6x^2 + 4x - 40 = 0.$$

13 For this question the non-zero vectors \mathbf{p} , \mathbf{q} , \mathbf{r} and \mathbf{s} are such that:

$$\mathbf{p} = a(\mathbf{i} + \mathbf{j}), \quad \mathbf{q} = 2\mathbf{i} - b\mathbf{j}, \quad \mathbf{r} = c\mathbf{i} + d\mathbf{j} \quad \text{and} \quad \mathbf{s} = e\mathbf{i} + f\mathbf{j}.$$

Find the possible values of a , b , c , d , e and f given that all of the following statements are true:

- \mathbf{p} is perpendicular to \mathbf{q} .
- $|\mathbf{p}| = |\mathbf{q}|$.
- $\mathbf{q} - 3\mathbf{r} = 23\mathbf{i} - 5\mathbf{j}$.
- \mathbf{s} is in the same direction as \mathbf{q} but equal in magnitude to \mathbf{r} .

2.

Polar form of a complex number

- Polar form of a complex number
- The abbreviated form for $\cos \theta + i \sin \theta$
- Multiplying and dividing complex numbers expressed in polar form
- Geometrical interpretation
- Regions in the complex plane
- The cube roots of 1
- N th roots of a non zero complex number
- De Moivre's theorem
- Miscellaneous exercise two



Polar form of a complex number

The *Preliminary work* section at the beginning of this book reminded you of the idea of representing a complex number $a + bi$ graphically on an **Argand diagram**, either as a point (a, b) or as a vector from the origin to the point (a, b) .

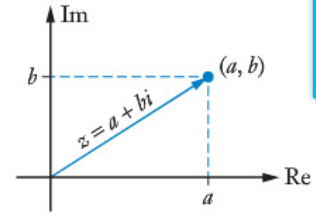

If we write $|z|$ for the magnitude of this vector, and if it makes an angle θ with the positive real axis, see diagram, then:

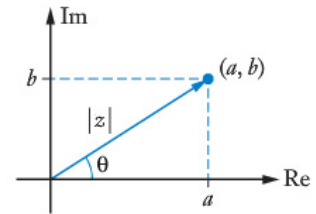
$$\begin{aligned} z &= a + bi \\ &= |z| \cos \theta + i |z| \sin \theta \\ &= |z| (\cos \theta + i \sin \theta) \end{aligned}$$

This is the **polar form** of the complex number z .

(Some calculators may refer to this as the ‘*Trig*’ form.)

- Note
- The magnitude of the complex number, $|z|$, is called the **modulus** of z , written $\text{mod } z$. (The letter r is also used for the modulus of a complex number.)
 - With $z = a + bi$, $|z| = \sqrt{a^2 + b^2}$.
 $|z| = \sqrt{a^2 + b^2}$ is the distance the point representing $a + bi$ is from the origin.
 It is the magnitude of the vector representing $a + bi$.
 - The angle θ , measured anticlockwise from the positive real axis, is said to be the **argument** of the complex number, written $\text{arg } z$.
 $\text{Arg } z$ is usually stated in radians but can be given in degrees.
 $\text{Arg } z$ is not defined for the number $(0 + 0i)$.
 - With θ in radians we could also refer to $(\theta \pm 2\pi)$, $(\theta \pm 4\pi)$, $(\theta \pm 6\pi)$, etc. as being the argument of a complex number that makes an angle θ with the positive real axis. To avoid this confusion we refer to the value $-\pi < \theta \leq \pi$ (or in degrees $-180^\circ < \theta \leq 180^\circ$) as the **principal argument** of the complex number. The interval $-\pi < \theta \leq \pi$ is sometimes written as $(-\pi, \pi]$. In this form, note carefully the significance of the type of bracket used.

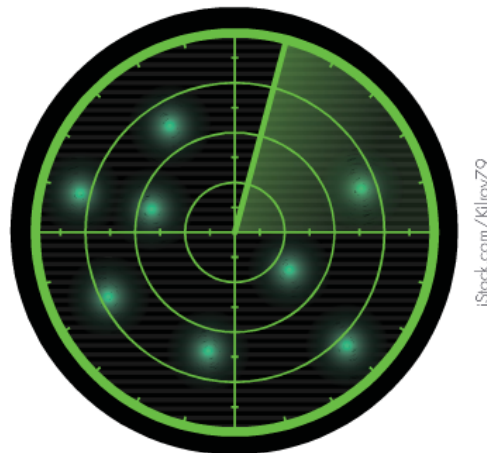

For the Argand diagram on the right:

z_1 has modulus 5 and principal argument $\frac{\pi}{3}$.

z_2 has modulus 6 and principal argument $\frac{3\pi}{4}$.

z_3 has modulus 3 and principal argument $-\frac{\pi}{2}$.

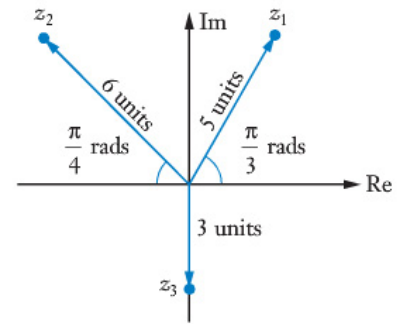

EXAMPLE 1

Express the complex number $3 + 4i$ in the form $r(\cos \theta + i \sin \theta)$, for $-\pi < \theta \leq \pi$, and with θ given correct to four decimal places.

Solution

From the sketch on the right we see that

$$\begin{aligned} \text{mod } z &= \sqrt{3^2 + 4^2} \\ &= 5 \end{aligned}$$

and $\tan \theta = \frac{4}{3}$

$\therefore \arg z = 0.9273$ rads (correct to 4 decimal places)

Thus $z = 5(\cos 0.9273 + i \sin 0.9273)$

Alternatively we could use the ability of some calculators to

- determine $\text{mod } z$ and $\arg z$,
- to convert cartesian coordinates to polar coordinates direct.

Thus, as before, the complex number

$$z = 3 + 4i$$

has the **polar form**:

$$z = 5(\cos 0.9273 + i \sin 0.9273)$$

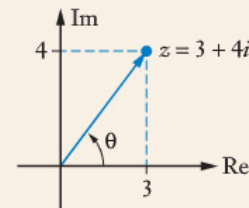

$ 3 + 4i $	5
$\arg(3 + 4i)$	0.927295218
$\text{toPol}\left(\begin{bmatrix} 3 \\ 4 \end{bmatrix}\right)$	$\left[\begin{array}{c} 5 \\ \angle(0.927295218) \end{array} \right]$

Note • $z = a + ib$ is the **rectangular** or **cartesian** form of the complex number z .

This cartesian form is sometimes written as the ordered pair (a, b) .

- In the polar form, $z = r(\cos \theta + i \sin \theta)$, r and θ are real and it is usual to have

$$r \geq 0 \text{ and } -\pi < \theta \leq \pi.$$

This polar form can also be written as an ordered pair (r, θ) , with squared brackets $[r, \theta]$ sometimes used to distinguish polar form.

Exercise 2A

1 Find $|z|$ for each of the following, giving exact answers.

a $z = 4 - 3i$

b $z = 12 + 5i$

c $z = 3 + 2i$

d $z = 3 - 2i$

e $z = 1 + 5i$

f $z = 5i$

2 Find the principal argument of each of the following complex numbers, giving exact answers in radians.

a $z = 2 + 2i$

b $z = 2 - 2i$

c $z = -2 + 2i$

d $z = -2 - 2i$

e $z = -2 + 2\sqrt{3}i$

f $z = 3 - 3\sqrt{3}i$

3 Express the complex numbers z_1 to z_{12} , given below, in the form

$$r(\cos \theta + i \sin \theta), \text{ with } r \geq 0 \text{ and } -\pi < \theta \leq \pi.$$

$$z_1 = 3 \left(\cos \frac{13\pi}{6} + i \sin \frac{13\pi}{6} \right)$$

$$z_2 = 3(\cos 3\pi + i \sin 3\pi)$$

$$z_3 = 4 \left(\cos \frac{5\pi}{4} + i \sin \frac{5\pi}{4} \right)$$

$$z_4 = 2(\cos(-\pi) + i \sin(-\pi))$$

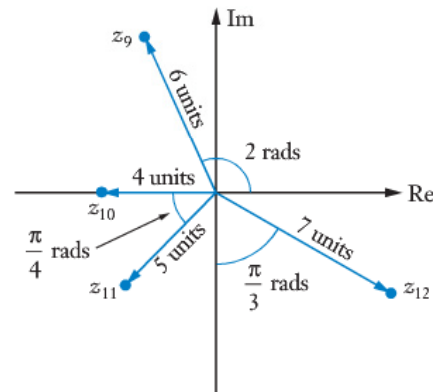
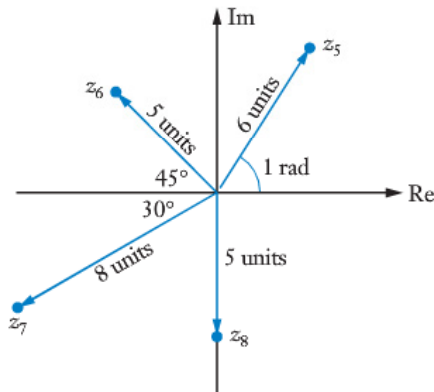

4 Express the complex numbers z_{13} to z_{26} , given below, in the form

$$r(\cos \theta + i \sin \theta), \text{ with } r \geq 0 \text{ and } -\pi < \theta \leq \pi$$

stating r exactly and θ correct to 4 decimal places (if rounding is necessary).

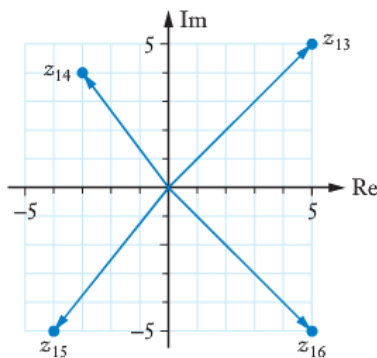

$$z_{17} = 5 + 12i$$

$$z_{18} = 1 + 7i$$

$$z_{19} = 1 - 7i$$

$$z_{20} = -7 + i$$

$$z_{21} = 5\sqrt{3} + 5i$$

$$z_{22} = 4i$$

$$z_{23} = 4$$

$$z_{24} = -4$$

$$z_{25} = -3i$$

$$z_{26} = 3$$

5 Express z_{27} to z_{32} in the form $a + bi$, with a and b stated exactly.

$$z_{27} = 2 \left(\cos \frac{\pi}{4} + i \sin \frac{\pi}{4} \right)$$

$$z_{28} = 4 \left(\cos \frac{5\pi}{6} + i \sin \frac{5\pi}{6} \right)$$

$$z_{29} = 4 \left(\cos \left(-\frac{\pi}{3} \right) + i \sin \left(-\frac{\pi}{3} \right) \right)$$

$$z_{30} = 6 \left(\cos \left(-\frac{2\pi}{3} \right) + i \sin \left(-\frac{2\pi}{3} \right) \right)$$

$$z_{31} = 5(\cos 2\pi + i \sin 2\pi)$$

$$z_{32} = \left(\cos \frac{7\pi}{2} + i \sin \frac{7\pi}{2} \right)$$

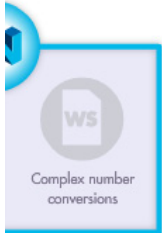

The abbreviated form for $\cos \theta + i \sin \theta$

To save us having to write $\cos \theta + i \sin \theta$ we can use the abbreviation $\text{cis } \theta$.

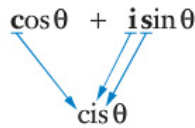

Thus $r(\cos \theta + i \sin \theta) = r \text{cis } \theta$.

e.g. $5(\cos 2 + i \sin 2) = 5 \text{cis } 2$.

$$\begin{aligned} 4 \text{cis } \frac{\pi}{3} &= 4 \left(\cos \frac{\pi}{3} + i \sin \frac{\pi}{3} \right) \\ &= 2 + 2\sqrt{3}i. \end{aligned}$$

EXAMPLE 2

Express each of the following in the form $r \text{cis } \theta$, with $r \geq 0$ and $-\pi < \theta \leq \pi$.

a $3 - 3i$,

b $3i$,

c -4 .

Solution

a $\text{mod}(3 - 3i) = \sqrt{3^2 + (-3)^2}$
 $= 3\sqrt{2}$

$$\arg(3 - 3i) = -\frac{\pi}{4}$$

$$\therefore 3 - 3i = 3\sqrt{2} \text{cis} \left(-\frac{\pi}{4} \right)$$

b $3i = 3 \text{cis} \frac{\pi}{2}$

c $-4 = 4 \text{cis } \pi$

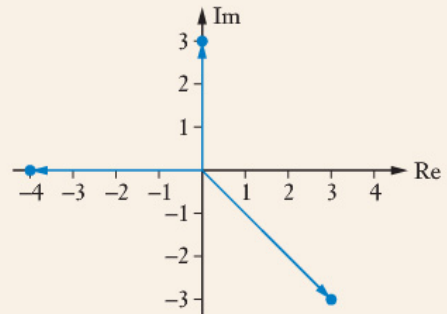

Exercise 2B

1 Express z_1 to z_8 shown below in the form $r \operatorname{cis} \theta$, with $r \geq 0$ and $-\pi < \theta \leq \pi$.

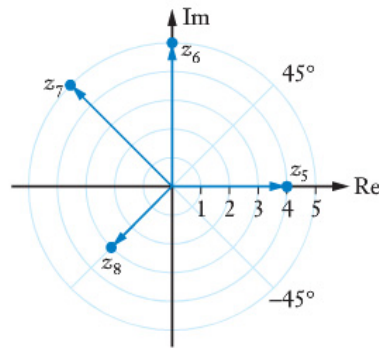
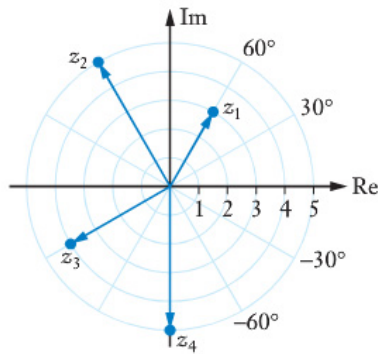

Express each of the following in the form $r \operatorname{cis} \theta$, with $r \geq 0$ and $-\pi < \theta \leq \pi$.

2 $2 \left(\cos \frac{\pi}{10} + i \sin \frac{\pi}{10} \right)$

3 $7 \left(\cos \frac{5\pi}{8} + i \sin \frac{5\pi}{8} \right)$

4 $9(\cos 30^\circ + i \sin 30^\circ)$

5 $3(\cos 330^\circ + i \sin 330^\circ)$

6 $5 \left(\cos \frac{3\pi}{2} + i \sin \frac{3\pi}{2} \right)$

7 $4 \left(\cos \frac{8\pi}{3} + i \sin \frac{8\pi}{3} \right)$

8 $2 \left(\cos \left(-\frac{5\pi}{3} \right) + i \sin \left(-\frac{5\pi}{3} \right) \right)$

9 $2(\cos(-3\pi) + i \sin(-3\pi))$

Simplify:

10 $7 \operatorname{cis} \frac{\pi}{2}$

11 $5 \operatorname{cis} \left(-\frac{\pi}{2} \right)$

12 $\operatorname{cis} \pi$

13 $3 \operatorname{cis} 2\pi$

Express each of the following in the form $a + bi$, with exact values for a and b .

14 $10 \operatorname{cis} \frac{\pi}{4}$

15 $4 \operatorname{cis} \frac{2\pi}{3}$

16 $4 \operatorname{cis} \left(-\frac{2\pi}{3} \right)$

17 $12 \operatorname{cis} \left(-\frac{4\pi}{3} \right)$

Express each of the following in the form $r \operatorname{cis} \theta$, for $-\pi < \theta \leq \pi$. Give r (≥ 0) as an exact value and, if rounding is necessary, give θ correct to 4 decimal places.

18 $-7 + 24i$

19 $-5 + 12i$

20 $1 + 2i$

21 $5i$

22 If $z = a + bi$ we define \bar{z} , the complex **conjugate** of z , as $\bar{z} = a - bi$.

a Make a copy of the Argand diagram shown on the right and include \bar{z} and \bar{w} .

b If $z = r_1 \operatorname{cis} \alpha$, $-\pi < \alpha \leq \pi$,
and $w = r_2 \operatorname{cis} \beta$, $-\pi < \beta \leq \pi$,
express \bar{z} and \bar{w} in 'cis form'.

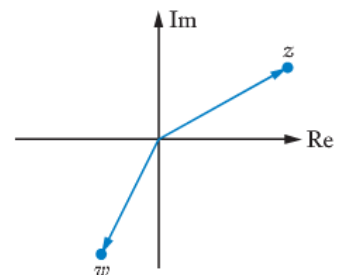

Find the complex conjugates of the following, giving your answers in polar form, $r \operatorname{cis} \theta^\circ$, with $r \geq 0$ and $-180 < \theta \leq 180$.

23 $2 \operatorname{cis} 30^\circ$

24 $7 \operatorname{cis} 120^\circ$

25 $4 \operatorname{cis} 390^\circ$

26 $10 \operatorname{cis}(-200^\circ)$

Find the complex conjugates of the following, giving answers in polar form, $r \operatorname{cis} \theta$, with $r \geq 0$ and $-\pi < \theta \leq \pi$.

27 $2 \operatorname{cis} \frac{\pi}{2}$

28 $5 \operatorname{cis} \left(-\frac{3\pi}{4} \right)$

29 $5 \operatorname{cis} 0.5$

30 $5 \operatorname{cis} \frac{7\pi}{2}$



Multiplying and dividing complex numbers expressed in polar form

Suppose that $z = r_1 \operatorname{cis} \alpha$ and $w = r_2 \operatorname{cis} \beta$
 $= r_1(\cos \alpha + i \sin \alpha)$ $= r_2(\cos \beta + i \sin \beta)$

Then $zw = (r_1 \operatorname{cis} \alpha)(r_2 \operatorname{cis} \beta)$
 $= r_1 r_2 (\cos \alpha + i \sin \alpha)(\cos \beta + i \sin \beta)$
 $= r_1 r_2 [(\cos \alpha \cos \beta - \sin \alpha \sin \beta) + i(\sin \alpha \cos \beta + \cos \alpha \sin \beta)]$
 $= r_1 r_2 [\cos(\alpha + \beta) + i \sin(\alpha + \beta)]$
 $= r_1 r_2 \operatorname{cis}(\alpha + \beta)$

Or, using the 'square bracket' notation: $[r_1, \alpha][r_2, \beta] = [r_1 r_2, \alpha + \beta]$

Thus: **When we multiply two complex numbers we multiply the moduli and add the arguments** (adding or subtracting multiples of 2π to ensure $-\pi < \arg \leq \pi$).

The reader is left to confirm that if $z = r_1 \operatorname{cis} \alpha$ and $w = r_2 \operatorname{cis} \beta$

then $\frac{z}{w} = \frac{r_1}{r_2} \operatorname{cis}(\alpha - \beta)$.

I.e.: **When we divide two complex numbers we divide the moduli and subtract the arguments** (adding or subtracting multiples of 2π to ensure $-\pi < \arg \leq \pi$).

(Question: Is the order of subtraction of the angles important?)

EXAMPLE 3

If $z = 5 \operatorname{cis} \frac{3\pi}{4}$ and $w = 2 \operatorname{cis} \frac{\pi}{3}$ express each of the following in the form $r \operatorname{cis} \theta$ with $r \geq 0$ and $-\pi < \theta \leq \pi$.

a zw

b $\frac{z}{w}$

c $2z$

d iz

Solution

$$\begin{aligned} \mathbf{a} \quad zw &= 5 \operatorname{cis} \frac{3\pi}{4} \cdot 2 \operatorname{cis} \frac{\pi}{3} \\ &= 10 \operatorname{cis} \left(\frac{3\pi}{4} + \frac{\pi}{3} \right) \\ &= 10 \operatorname{cis} \frac{13\pi}{12} \\ &= 10 \operatorname{cis} \left(-\frac{11\pi}{12} \right) \end{aligned}$$

$$\begin{aligned} \mathbf{b} \quad \frac{z}{w} &= \left(5 \operatorname{cis} \frac{3\pi}{4} \right) \div \left(2 \operatorname{cis} \frac{\pi}{3} \right) \\ &= \frac{5}{2} \operatorname{cis} \left(\frac{3\pi}{4} - \frac{\pi}{3} \right) \\ &= 2.5 \operatorname{cis} \frac{5\pi}{12} \end{aligned}$$

$$\begin{aligned} \mathbf{c} \quad 2z &= 2 \operatorname{cis} 0 \cdot 5 \operatorname{cis} \frac{3\pi}{4} \\ &= 10 \operatorname{cis} \frac{3\pi}{4} \end{aligned}$$

$$\begin{aligned} \mathbf{d} \quad iz &= 1 \operatorname{cis} \frac{\pi}{2} \cdot 5 \operatorname{cis} \frac{3\pi}{4} \\ &= 5 \operatorname{cis} \left(-\frac{3\pi}{4} \right) \end{aligned}$$

Geometrical interpretation

If $z = r_1 \operatorname{cis} \alpha$ and $w = r_2 \operatorname{cis} \beta$

then $zw = r_1 r_2 \operatorname{cis} (\alpha + \beta)$.

Thus the effect of multiplying z by w is to rotate z anticlockwise about the origin by an angle β , and increase the length of z by a factor $|w|$.

For example suppose that $z = 3 \operatorname{cis} 80^\circ$ and $w = 2 \operatorname{cis} 50^\circ$.

It follows that $zw = (3 \operatorname{cis} 80^\circ)(2 \operatorname{cis} 50^\circ)$
 $= 6 \operatorname{cis} 130^\circ$,

i.e. a 50° anticlockwise rotation of z about the origin with a doubling of length, as shown below.

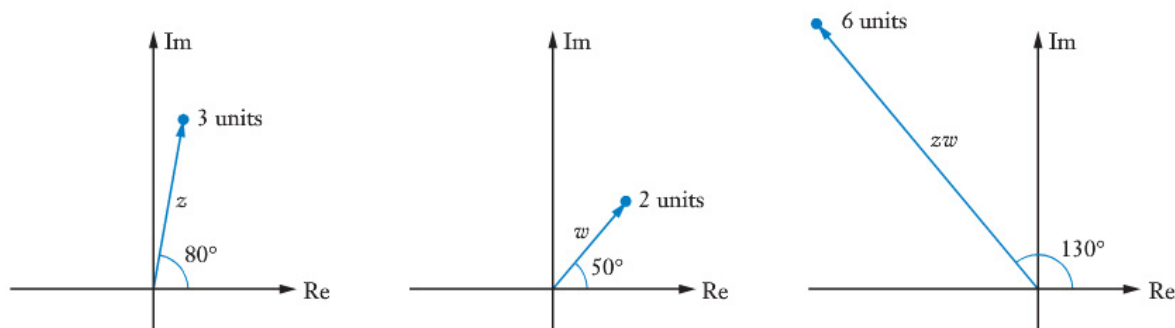

Exercise 2C

Determine zw for each of the following, giving your answer in the same form as z and w are given.

1 $z = 2 + 3i$, $w = 5 - 2i$.

2 $z = 3 + 2i$, $w = -1 + 2i$.

3 $z = 3 \operatorname{cis} 60^\circ$, $w = 5 \operatorname{cis} 20^\circ$.

4 $z = 3 \operatorname{cis} 120^\circ$, $w = 3 \operatorname{cis} 150^\circ$.

5 $z = 3 \operatorname{cis} 30^\circ$, $w = 3 \operatorname{cis}(-80^\circ)$.

6 $z = 5 \operatorname{cis} \frac{\pi}{3}$, $w = 2 \operatorname{cis} \frac{\pi}{4}$.

7 $z = 4 \operatorname{cis}\left(\frac{\pi}{4}\right)$, $w = 2 \operatorname{cis}\left(-\frac{3\pi}{4}\right)$.

8 $z = 2(\cos 50^\circ + i \sin 50^\circ)$, $w = \cos 60^\circ + i \sin 60^\circ$.

9 $z = 2(\cos 170^\circ + i \sin 170^\circ)$, $w = 3(\cos 150^\circ + i \sin 150^\circ)$.

Determine $\frac{z}{w}$ for each of the following, giving your answer in the same form as z and w are given.

10 $z = 6 - 3i$, $w = 3 - 4i$.

11 $z = -6 + 3i$, $w = -3 + 4i$.

12 $z = 8 \operatorname{cis} 60^\circ$, $w = 2 \operatorname{cis} 40^\circ$.

13 $z = 5 \operatorname{cis} 120^\circ$, $w = \operatorname{cis} 150^\circ$.

14 $z = 3 \operatorname{cis}(-150^\circ)$, $w = 3 \operatorname{cis} 80^\circ$.

15 $z = 2 \operatorname{cis} \frac{3\pi}{5}$, $w = 2 \operatorname{cis} \frac{2\pi}{5}$.

16 $z = 4 \operatorname{cis}\left(\frac{\pi}{4}\right)$, $w = 2 \operatorname{cis}\left(-\frac{3\pi}{4}\right)$.

17 $z = 5\left(\cos \frac{3\pi}{4} + i \sin \frac{3\pi}{4}\right)$, $w = 2\left(\cos \frac{\pi}{2} + i \sin \frac{\pi}{2}\right)$.

18 $z = 2(\cos 50^\circ + i \sin 50^\circ)$, $w = 5(\cos 50^\circ + i \sin 50^\circ)$.

Use the following diagrams to determine the complex number w in the form $r \operatorname{cis} \theta$ for $r \geq 0$ and with $-180^\circ < \theta \leq 180^\circ$.

19

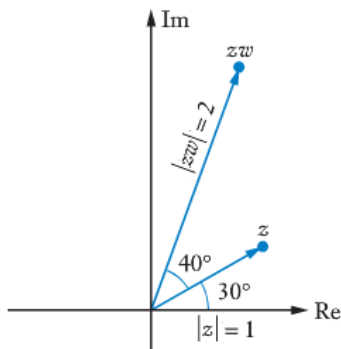

20

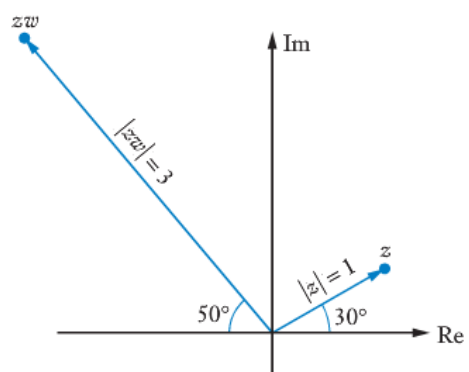

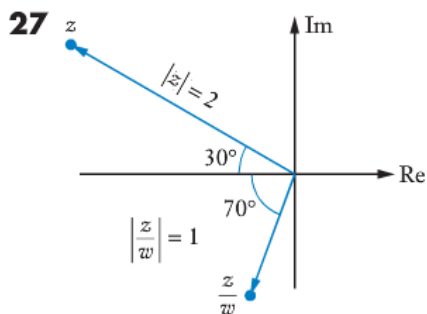
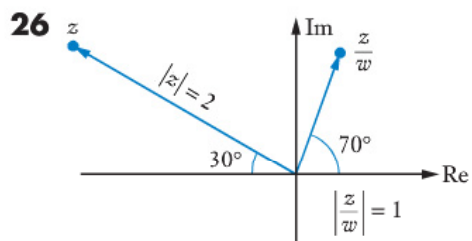
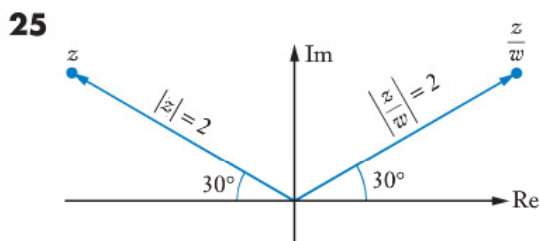
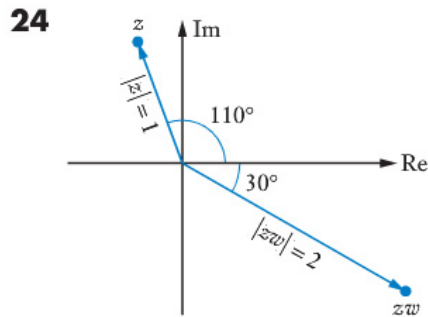
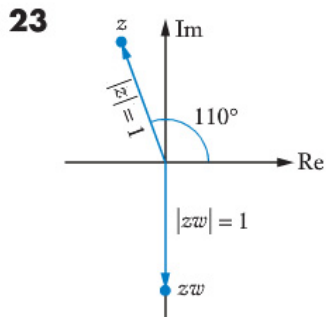
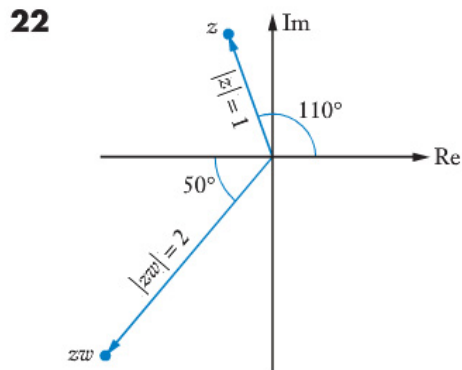
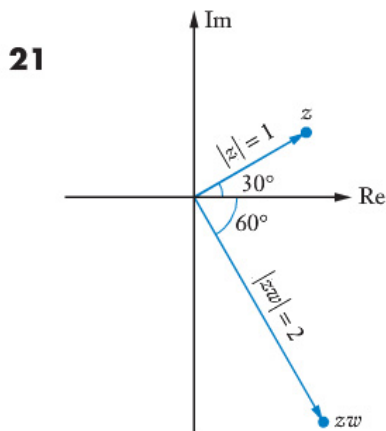

28 If $z = 6 \operatorname{cis} 40^\circ$ and $w = 2 \operatorname{cis} 30^\circ$ determine

- | | | | |
|---------------|---------------|------------------------|------------------------|
| a $2z$ | b $3w$ | c zw | d wz |
| e iz | f iw | g $\frac{w}{z}$ | h $\frac{1}{z}$ |

29 If $z = 8 \operatorname{cis} \frac{2\pi}{3}$ and $w = 4 \operatorname{cis} \frac{3\pi}{4}$ determine

- | | | | |
|---------------------|--------------------|------------------------|------------------------|
| a $z\bar{w}$ | b wz | c $\frac{w}{z}$ | d $\frac{z}{w}$ |
| e \bar{z} | f \bar{w} | g $\frac{1}{z}$ | h $\frac{i}{w}$ |



Regions in the complex plane

We know that we can represent the complex number $z = a + ib$ as a point (a, b) on an Argand diagram. If we are then given some condition or rule that z must obey, the set of all such z 's obeying the rule will form a set of points on our Argand diagram. For example, any complex number, z , obeying the rule

$$|z| = k$$

will be a distance of k from the origin. The set of all complex numbers, z , obeying this rule, written $\{z: |z| = k\}$ and read as 'the set of all z such that mod z equals k ' would together form a circle, centre at the origin and radius k .

We say that the **locus** of $|z| = k$ is a circle centre the origin and radius k .

Examples:

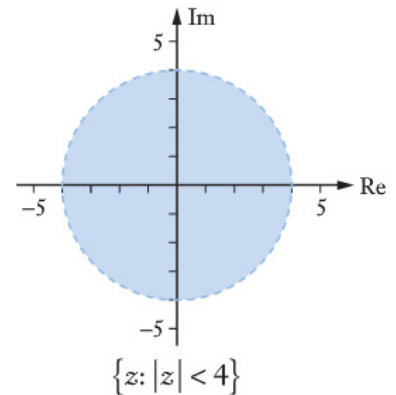
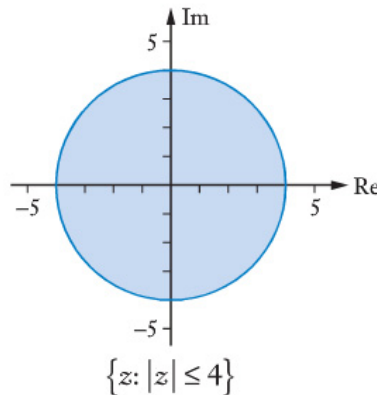
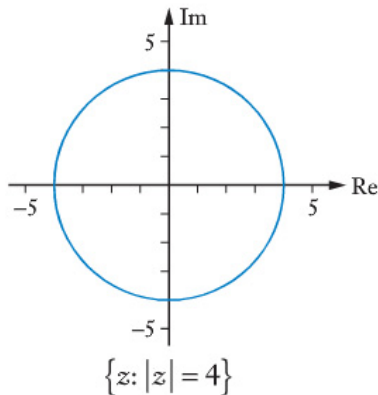

Now consider $\{z: |z - w| = k\}$. The *Preliminary work* section at the beginning of this book reminded us that $|x - a|$ is the distance the number x is from the number a . Similarly, for complex numbers z and w , $|z - w|$ is the distance between z and w in the complex plane (see the diagrams below).

Vector justification

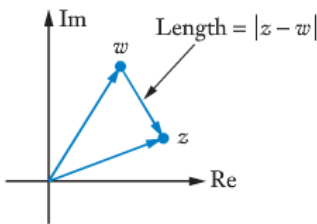

Coordinate justification

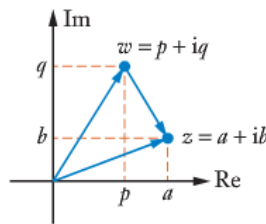

$$\begin{aligned} z - w &= (a - p) + (b - q)i \\ |z - w| &= \sqrt{(a - p)^2 + (b - q)^2} \\ &= \text{distance between } z \text{ and } w. \end{aligned}$$

Thus the complex numbers, z , for which $|z - w| = k$, would together form a circle, centre at w and radius k . We say that the locus of $|z - w| = k$ is a circle centre w and radius k .

For example, the Argand diagram on the right shows the locus of all points in the complex plane for which

$$|z - (1 + 2i)| \leq 3.$$

i.e. it shows the set $\{z: |z - (1 + 2i)| \leq 3\}$

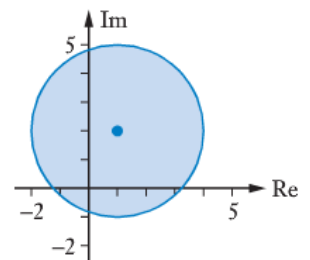

EXAMPLE 4

- a** Represent $\{z: |z - 2 - i| = 3\}$ on an Argand diagram.
b If $z = x + iy$ determine the cartesian equation for the set of points in **a**.

Solution

- a** $\{z: |z - w| = k\}$ is a circle centre w and radius k .
 Thus $\{z: |z - (2 + i)| = 3\}$ is a circle centre $(2 + i)$ and radius 3.
 This is shown in the diagram on the right.

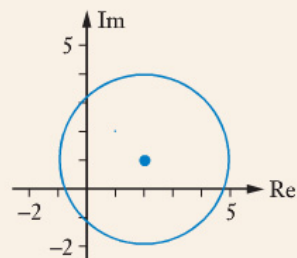

- b** Now $|z - 2 - i| = 3$
 Thus if $z = x + iy$ $|x + iy - 2 - i| = 3$
 $|(x - 2) + i(y - 1)| = 3$
 $\therefore (x - 2)^2 + (y - 1)^2 = 9$

Note: As we were reminded in the *Preliminary work* section at the beginning of this book, cartesian equations of the form

$$(x - p)^2 + (y - q)^2 = a^2$$

are those of circles, centre (p, q) and radius a . Hence our answer for part **b**, above, confirms our answer for part **a**.

EXAMPLE 5

- a** Represent $\{z: |z - 2i| = |z - 4|\}$ on an Argand diagram.
b If $z = x + iy$ determine the cartesian equation for the set of points in **a**.

Solution

- a** $|z - w|$ is the distance from z to w .
 Thus $|z - 2i|$ is the distance from z to $0 + 2i$,
 and $|z - 4|$ is the distance from z to $4 + 0i$.
 Thus $\{z: |z - 2i| = |z - 4|\}$ is the set of all points equidistant from $2i$ and 4 . It is the perpendicular bisector of the line joining $2i$ and 4 .
 This is shown in the diagram on the right.

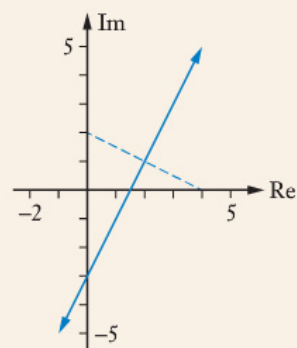

- b** Now $|z - 2i| = |z - 4|$
 Thus if $z = x + iy$ $|x + iy - 2i| = |x + iy - 4|$
 $x^2 + (y - 2)^2 = (x - 4)^2 + y^2$
 Which simplifies to $y = 2x - 3$
 The required cartesian equation is $y = 2x - 3$

EXAMPLE 6

Represent $\left\{z: \arg z = \frac{\pi}{6}\right\}$ on an Argand diagram.

Solution

If $\arg z = \frac{\pi}{6}$ then z makes an angle of $\frac{\pi}{6}$ with the positive x -axis, measured anticlockwise. Thus $\left\{z: \arg z = \frac{\pi}{6}\right\}$ is the set of points forming the 'half line' shown in the diagram on the right.

Note that the point $0 + 0i$ is not included because $\arg(0 + 0i)$ is undefined.

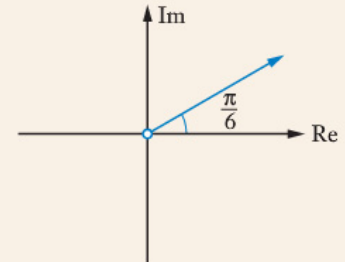

EXAMPLE 7

Show that the set of all points z in the complex plane that are such that

$$|z - (8 + i)| = 2|z - (2 + 4i)|$$

together form a circle in the complex plane and find the centre and radius of the circle.

Solution

Given:

$$|z - (8 + i)| = 2|z - (2 + 4i)|$$

Thus if $z = x + iy$

$$|x + iy - (8 + i)| = 2|x + iy - (2 + 4i)|$$

$$(x - 8)^2 + (y - 1)^2 = 2^2[(x - 2)^2 + (y - 4)^2]$$

$$x^2 - 16x + 64 + y^2 - 2y + 1 = 2^2[x^2 - 4x + 4 + y^2 - 8y + 16]$$

Which simplifies to

$$0 = 3x^2 + 3y^2 - 30y + 15$$

i.e.

$$0 = x^2 + y^2 - 10y + 5$$

Create gaps:

$$x^2 + y^2 - 10y + \quad = -5$$

Complete the square

$$x^2 + y^2 - 10y + 25 = -5 + 25$$

Hence

$$x^2 + (y - 5)^2 = 20$$

A circle, centre $(0, 5)$ and radius $2\sqrt{5}$.

Note that points in the complex plane such that

$$|z - (8 + i)| = 2|z - (2 + 4i)|$$

are the points for which the distance to the point $(8 + i)$ is twice that of the distance to the point $(2 + 4i)$.

We would expect two such points to be $4 + 3i$ and $-4 + 7i$ (see diagram). The reader should confirm that, for $z = x + iy$, such points do indeed satisfy the equation $x^2 + (y - 5)^2 = 20$.

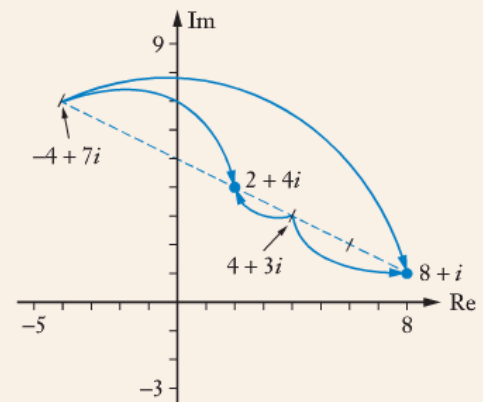

Exercise 2D

For each of the following sets, choose the appropriate diagram from those labelled A to P below.

1 $\{z: \text{Im}(z) = 3\}$

2 $\{z: \text{Re}(z) = 3\}$

3 $\{z: \arg z = -45^\circ\}$

4 $\{z: \arg z = 135^\circ\}$

5 $\{z: |z| \leq 3\}$

6 $\{z: |z - 3 + 3i| = 3\}$

7 $\{z: |z + 8| = |z - 4i|\}$

8 $\{z: |z + 2 + 3i| = |z - 4 + i|\}$

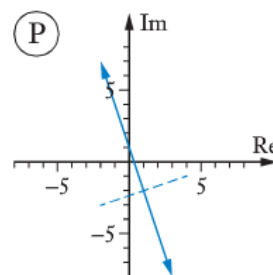
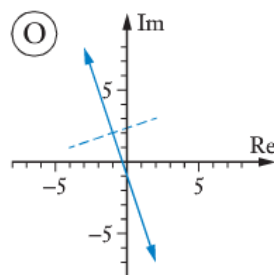
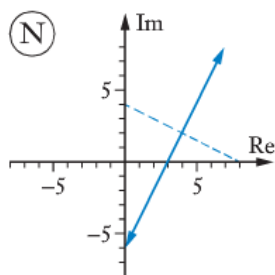
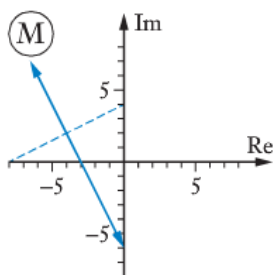
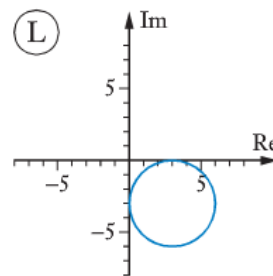
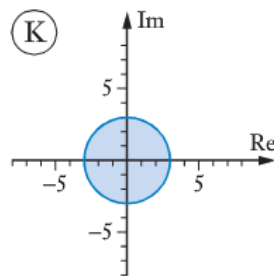
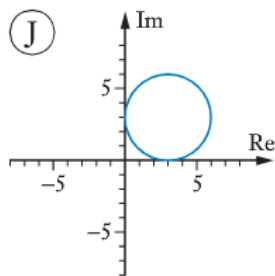
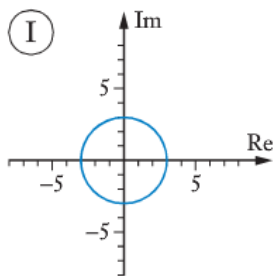
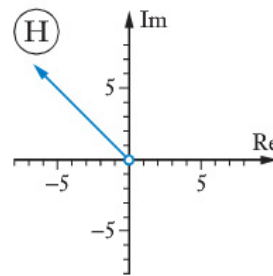
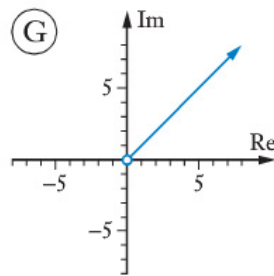
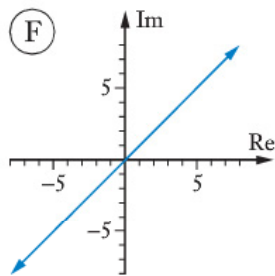
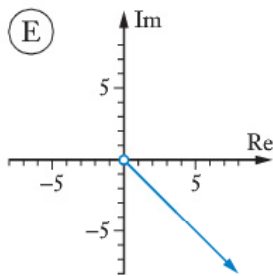
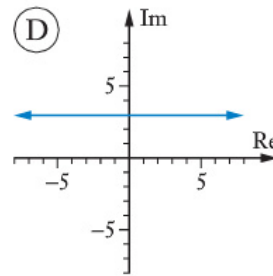
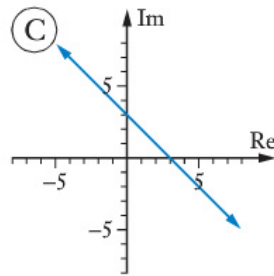
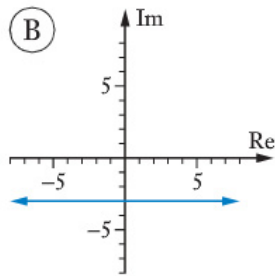
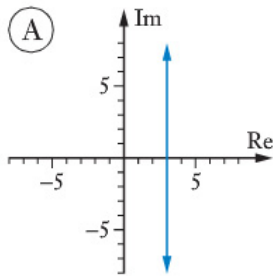

Represent each of the following sets of points diagrammatically as lines or regions in the complex plane and, with $z = x + iy$, determine the cartesian equation of each.

9 $\{z: \operatorname{Re}(z) = 5\}$

10 $\{z: \operatorname{Im}(z) = -4\}$

11 $\left\{z: \arg z = \frac{\pi}{3}\right\}$

12 $\left\{z: \arg z = -\frac{\pi}{3}\right\}$

13 $\{z: \operatorname{Re}(z) + \operatorname{Im}(z) = 6\}$

14 $\{z: |z| = 6\}$

15 $\{z: |z - 4i| \leq 3\}$

16 $\{z: |z - (2 + 3i)| = 4\}$

17 $\{z: |z - 2 + 3i| = 4\}$

18 $\{z: |z - 2| = |z - 6|\}$

19 $\{z: |z - 6i| = |z - 2|\}$

20 $\{z: |z - (2 + i)| = |z - (4 - 5i)|\}$

21 $\{z: 3 \leq |z| \leq 5\}$

22 $\left\{z: \frac{\pi}{6} \leq \arg z \leq \frac{\pi}{3}\right\}$

23 $\{z: \operatorname{Im}(z) \geq 2 \operatorname{Re}(z) + 1\}$

24 $\{z: \operatorname{Im}(z) < 2 - \operatorname{Re}(z)\}$

25 For $\{z: |z + 3 - 3i| = 2\}$ determine:

- a** the minimum possible value of $\operatorname{Im}(z)$,
- b** the maximum possible value of $|\operatorname{Re}(z)|$,
- c** the minimum possible value of $|z|$,
- d** the maximum possible value of $|z|$,
- e** the maximum possible value of $|\bar{z}|$.

26 For $\{z: |z - (4 + 3i)| = 2\}$ determine:

- a** the minimum possible value of $\operatorname{Im}(z)$,
- b** the maximum possible value of $\operatorname{Re}(z)$,
- c** the maximum possible value of $|z|$,
- d** the minimum possible value of $|z|$,
- e** the minimum possible value of $\arg(z)$, giving your answer in radians correct to two decimal places,
- f** the maximum possible value of $\arg(z)$, giving your answer in radians correct to two decimal places.

27 Show that the set of all points z in the complex plane that are such that

$$|z - (2 + 3i)| = 2|z - (5 - 3i)|$$

together form a circle in the complex plane and find the centre and radius of the circle.

28 Show that the set of all points z in the complex plane that are such that

$$|z - (10 + 5i)| = 3|z - (2 - 3i)|$$

together form a circle in the complex plane and find the centre and radius of the circle.



The cube roots of 1

Suppose we are asked to solve the equation $x^3 = 1$,
i.e. $x^3 - 1 = 0$

We could use a calculator to obtain the three solutions:

$$x = 1$$

$$x = -\frac{1}{2} - \frac{\sqrt{3}}{2}i$$

and

$$x = -\frac{1}{2} + \frac{\sqrt{3}}{2}i.$$

solve($x^3 = 1, x$)

$$\left\{ x = 1, x = -\frac{1}{2} - \frac{\sqrt{3} \cdot i}{2}, x = -\frac{1}{2} + \frac{\sqrt{3} \cdot i}{2} \right\}$$

Alternatively these three solutions can be obtained algebraically by first using the fact that

$$x^3 - 1 = (x - 1)(x^2 + x + 1)$$

(The reader should check the truth of this statement by expanding the right hand side.)

Then, if $x^3 - 1 = 0$
 $(x - 1)(x^2 + x + 1) = 0$

Thus either $x - 1 = 0$ or $x^2 + x + 1 = 0$
 giving $x = 1$ or

$$x = \frac{-1 \pm \sqrt{1^2 - 4(1)(1)}}{2(1)}$$

$$= -\frac{1}{2} \pm \frac{\sqrt{3}}{2}i$$

Thus the three cube roots of 1 are: 1,
 $-\frac{1}{2} + \frac{\sqrt{3}}{2}i$
 and $-\frac{1}{2} - \frac{\sqrt{3}}{2}i.$

These three cube roots of 1 are shown as z_1, z_2 and z_3 in the Argand diagram on the right.

In 'cis' form $z_1 = 1 \text{ cis } 0$
 $z_2 = 1 \text{ cis } \frac{2\pi}{3}$
 $z_3 = 1 \text{ cis } \left(-\frac{2\pi}{3}\right)$

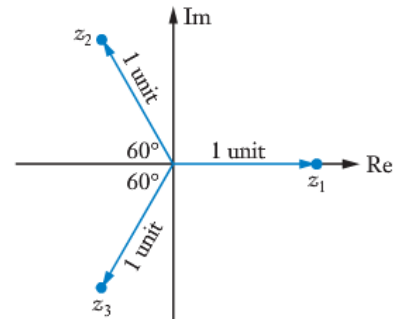

Notice that the three roots are each of unit length and divide the unit circle into three equal size regions. (The reasonableness of this should become apparent when you remember the rotational effect of complex number multiplication.)

This division into equal size regions can be used to determine other roots of 1, as the following example shows.

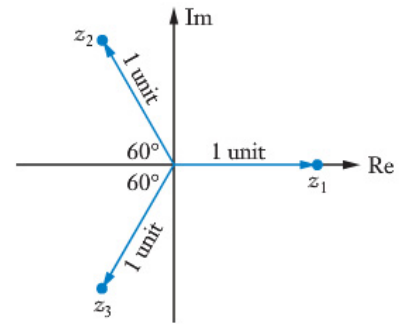

EXAMPLE 8

Find the fifth roots of 1, giving exact answers in the form $r \operatorname{cis} \theta$ with $r \geq 0$ and $-\pi < \theta \leq \pi$.

Solution

We must solve $z^5 = 1$.

One solution is $z = 1$ and this and the 4 others will divide the unit circle into five equal-sized regions (see diagram).

Thus the roots are $z_1 = 1 \operatorname{cis} 0$

$$z_2 = 1 \operatorname{cis} \frac{2\pi}{5}$$

$$z_3 = 1 \operatorname{cis} \frac{4\pi}{5}$$

$$z_4 = 1 \operatorname{cis} \left(-\frac{4\pi}{5}\right)$$

$$z_5 = 1 \operatorname{cis} \left(-\frac{2\pi}{5}\right)$$

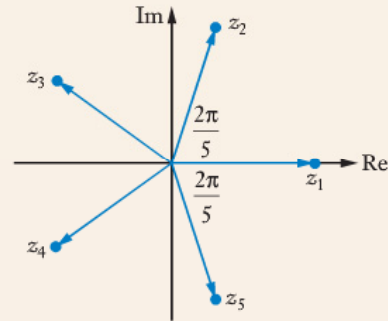

Nth roots of a non-zero complex number

If we know one of the roots of a complex number we can locate all the other roots using this idea of dividing the complex plane into equal size regions. This is demonstrated in the next two examples.

Note

Again your calculator may be able to determine the roots of complex numbers directly using its equation solving capabilities or other programmed routines. Whilst you are encouraged to explore the capability of your calculator in this regard make sure you understand the methods set out in the following examples and can use them when required.

EXAMPLE 9

Use your calculator to confirm that $(1 + i)^6$ is $-8i$.

By displaying the sixth roots of $-8i$ on an Argand diagram determine all six roots, expressing each in the form $r \operatorname{cis} \theta^\circ$ with $r \geq 0$ and $-180 < \theta \leq 180$.

Solution

The display shown on the right confirms that $(1 + i)^6$ is $-8i$.

Placing $(1 + i)$ on an Argand diagram and dividing the complex plane into six equal size regions allows the six roots to be determined:

$$\begin{aligned} z_1 &= \sqrt{2} \operatorname{cis} 45^\circ \\ z_2 &= \sqrt{2} \operatorname{cis} 105^\circ \\ z_3 &= \sqrt{2} \operatorname{cis} 165^\circ \\ z_4 &= \sqrt{2} \operatorname{cis} (-135^\circ) \\ z_5 &= \sqrt{2} \operatorname{cis} (-75^\circ) \\ z_6 &= \sqrt{2} \operatorname{cis} (-15^\circ) \end{aligned}$$

$$(1 + i)^6 = -8 \cdot i$$

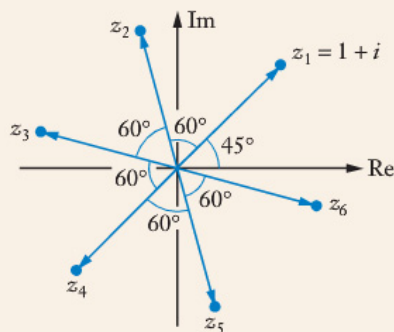

EXAMPLE 10

Use your calculator to confirm that $(3 + i)^4$ is $28 + 96i$. Show $(3 + i)$ and the three other fourth roots of $28 + 96i$ on an Argand diagram and express each in the form $a + bi$.

Solution

The display shown on the right confirms that $(3 + i)^4$ is $28 + 96i$.

Placing $(3 + i)$ on an Argand diagram and dividing the complex plane into four equal size regions allows the four roots to be determined:

$$\begin{aligned} z_1 &= 3 + i \\ z_2 &= -1 + 3i \\ z_3 &= -3 - i \\ z_4 &= 1 - 3i \end{aligned}$$

$$(3 + i)^4 = 28 + 96 \cdot i$$

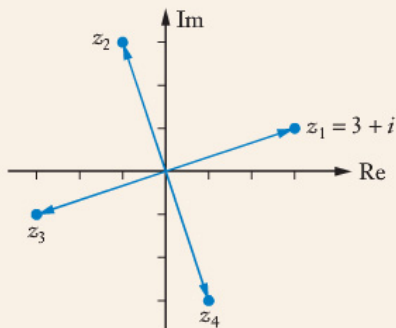

Exercise 2E

- Find the six solutions to the equation $z^6 = 1$ giving exact answers and all in the form $r \operatorname{cis} \theta$ with $r \geq 0$ and $-\pi < \theta \leq \pi$.
- Find the eight solutions to the equation $z^8 = 1$ giving exact answers and all in the form $r \operatorname{cis} \theta^\circ$ with $r \geq 0$ and $-180 < \theta \leq 180$.
- Find the seven solutions to the equation $z^7 = 1$ giving exact answers and all in the form $r \operatorname{cis} \theta$ with $r \geq 0$ and $-\pi < \theta \leq \pi$.
- Use your calculator to confirm that $(\sqrt{3} + i)^6$ is -64 . By displaying the sixth roots of -64 on an Argand diagram determine all six roots, expressing each root in the form $r \operatorname{cis} \theta$ with $r \geq 0$ and $-\pi < \theta \leq \pi$.
- Given that one solution to the equation $z^5 = -4 + 4i$ is $z = 1 - i$, display all five solutions on an Argand diagram and express each in the form $r \operatorname{cis} \theta^\circ$ with $r \geq 0$ and $-180 < \theta \leq 180$.
- Use your calculator to confirm that $(2 + 3i)^4$ is $-119 - 120i$. Show $(2 + 3i)$ and the three other fourth roots of $-119 - 120i$ on an Argand diagram and express each in the form $a + bi$.
- Without the assistance of a calculator, express
 - $(2 + i)^2$
 - $(2 + i)^4$
 in the form $a + bi$.
 - Display on an Argand diagram the four values of z for which

$$z^4 = -7 + 24i$$
 - Hence give the solutions to the above equation in the form $a + bi$.

- z_1 shown in the diagram on the right is one solution to the equation $z^5 = k$, for complex k .
Find k and the other four solutions to the equation, giving all answers in the form $r \operatorname{cis} \theta^\circ$ for $r \geq 0$ and $-180 < \theta \leq 180$.

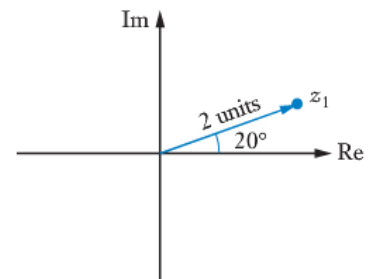

- z_1 shown in the diagram on the right is one solution to the equation $z^4 = k$, for complex k .
Find z_2, z_3 and z_4 , the other three solutions to the equation, giving all answers in the form $a + bi$.

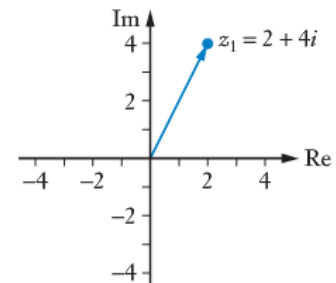



De Moivre's theorem

From $(r_1 \text{cis } \theta)(r_2 \text{cis } \alpha) = r_1 r_2 \text{cis } (\theta + \alpha)$
 it follows that $\text{cis } \theta \text{cis } \alpha = \text{cis } (\theta + \alpha)$
 and hence $(\text{cis } \theta)^2 = \text{cis } (\theta + \theta) = \text{cis } (2\theta)$.
 Continuing this idea: $(\text{cis } \theta)^3 = \text{cis } (\theta + \theta + \theta) = \text{cis } (3\theta)$
 $(\text{cis } \theta)^4 = \text{cis } (\theta + \theta + \theta + \theta) = \text{cis } (4\theta)$
 $\vdots \quad \quad \quad \vdots \quad \quad \quad \vdots$
 $(\text{cis } \theta)^n = \text{cis } (\theta + \theta + \theta + \dots) = \text{cis } (n\theta)$.

i.e. $(\cos \theta + i \sin \theta)^n = \cos n\theta + i \sin n\theta$

This result is called **de Moivre's theorem** and, whilst we have obtained it by considering positive integer values of n , it can be applied for all rational values of n .

Thus, with $z = |z| \text{cis } \theta$
 it follows that $z^n = |z|^n \text{cis } (n\theta)$

i.e. $(|z| \text{cis } \theta)^n = |z|^n \text{cis } (n\theta)$

an alternative statement of de Moivre's theorem.

In your study of *Mathematics Specialist Unit Two* you encountered the method of *proof by induction*.
 (If you have forgotten the technique, do a bit of revision to refresh your understanding of it.)
 Use the method of proof by induction to prove that
 $(\cos \theta + i \sin \theta)^n = \cos n\theta + i \sin n\theta$,
 i.e. de Moivre's theorem, is true for positive integer values of n .

The next three examples show how de Moivre's theorem can be used:

- to obtain expressions for $\cos n\theta$ and $\sin n\theta$ in terms of $\cos \theta$ and $\sin \theta$ (example 11)
- to find powers of a complex number (example 12)
- to find the n th roots of a complex number (example 13).



EXAMPLE 11

Use de Moivre's theorem to express $\cos 4\theta$ and $\sin 4\theta$ in terms of $\cos \theta$ and $\sin \theta$.

Solution

By de Moivre's theorem

$$\cos 4\theta + i \sin 4\theta = (\cos \theta + i \sin \theta)^4 \quad [1]$$

The right hand side of this statement expands to give:

$$\begin{aligned} & (\cos \theta)^4 + 4(\cos \theta)^3(i \sin \theta) + 6(\cos \theta)^2(i \sin \theta)^2 + 4(\cos \theta)(i \sin \theta)^3 + (i \sin \theta)^4 \\ = & \cos^4 \theta - 6 \cos^2 \theta \sin^2 \theta + \sin^4 \theta + i(4 \cos^3 \theta \sin \theta - 4 \cos \theta \sin^3 \theta) \end{aligned}$$

Equating real parts of equation [1] gives:

$$\cos 4\theta = \cos^4 \theta - 6 \cos^2 \theta \sin^2 \theta + \sin^4 \theta$$

and equating imaginary parts of equation [1] gives:

$$\sin 4\theta = 4 \cos^3 \theta \sin \theta - 4 \cos \theta \sin^3 \theta$$

EXAMPLE 12

Use de Moivre's theorem to determine $(2 + 2\sqrt{3}i)^4$, giving your answer in exact polar form.

Solution

First change $2 + 2\sqrt{3}i$ to 'cis form'.

$$2 + 2\sqrt{3}i = 4 \operatorname{cis} \frac{\pi}{3}$$

$$\text{Thus } (2 + 2\sqrt{3}i)^4 = \left(4 \operatorname{cis} \frac{\pi}{3}\right)^4$$

$$= 4^4 \operatorname{cis} \frac{4\pi}{3} \quad (\text{from de Moivre's theorem})$$

$$= 256 \operatorname{cis} \left(-\frac{2\pi}{3}\right)$$

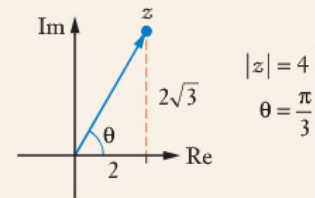

Note

The next example uses the fact that whilst we normally write the polar form of a complex number, z , as $r \operatorname{cis} \theta$, with $r \geq 0$ and $-\pi < \theta \leq \pi$, we could write z as $z = r \operatorname{cis}(\theta + 2k\pi)$, for $r \geq 0$ and k an integer.

EXAMPLE 13

Use de Moivre's theorem to determine the three cube roots of $(4\sqrt{3} + 4i)$, giving your answer in exact polar form.

Solution

$$4\sqrt{3} + 4i = 8 \operatorname{cis}\left(\frac{\pi}{6} + 2k\pi\right) \quad \text{for integer } k.$$

Thus we require z such that

$$z^3 = 8 \operatorname{cis}\left(\frac{\pi}{6} + 2k\pi\right)$$

$$\begin{aligned} \therefore z &= \left[8 \operatorname{cis}\left(\frac{\pi}{6} + 2k\pi\right)\right]^{\frac{1}{3}} \\ &= \sqrt[3]{8} \operatorname{cis}\left(\frac{\pi}{18} + \frac{2k\pi}{3}\right) \quad (\text{by de Moivre's theorem}) \\ &= 2 \operatorname{cis}\left(\frac{\pi}{18} + \frac{2k\pi}{3}\right) \end{aligned}$$

If $k = 0$ we have: $2 \operatorname{cis}\left(\frac{\pi}{18}\right)$ (Sometimes referred to as the **principal** root.)

$k = 1$ gives: $2 \operatorname{cis}\left(\frac{13\pi}{18}\right)$

$k = 2$ gives: $2 \operatorname{cis}\left(\frac{25\pi}{18}\right)$ i.e. $2 \operatorname{cis}\left(-\frac{11\pi}{18}\right)$.

Thus the three cube roots of $4\sqrt{3} + 4i$ are $2 \operatorname{cis}\left(\frac{\pi}{18}\right)$, $2 \operatorname{cis}\left(\frac{13\pi}{18}\right)$ and $2 \operatorname{cis}\left(-\frac{11\pi}{18}\right)$.

Wondering what happens if we continue the above process by letting $k = 3, 4$, etc.? Are there more than three cube roots? If you are not sure what will happen try it and see.

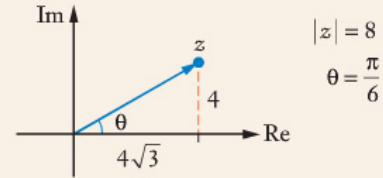

EXAMPLE 14

The complex number z is such that $z = r \operatorname{cis} \theta$, with $r > 0$ and $0 \leq \theta \leq \frac{\pi}{2}$.

Express **a** \bar{z} **b** $-z$ **c** z^2

in the form $a \operatorname{cis} \beta$ where $a > 0$ and $-\pi < \beta \leq \pi$.

Solution

a If $z = r \operatorname{cis} \theta$
 $= r \cos \theta + ir \sin \theta$
 then $\bar{z} = r \cos \theta - ir \sin \theta$
 $= r \operatorname{cis}(-\theta)$. (See diagram.)

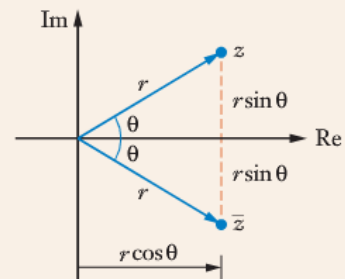

b If $z = r \operatorname{cis} \theta$
 $= r \cos \theta + ir \sin \theta$
 then $-z = -r \cos \theta - ir \sin \theta$
 $= r \operatorname{cis}(-\pi + \theta)$ (See diagram.)
 $= r \operatorname{cis}(\theta - \pi)$

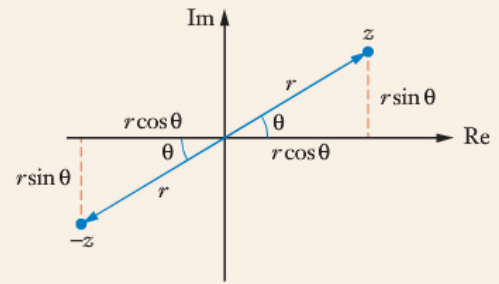

Or, using the fact that -1 can be written as $1 \operatorname{cis} \pi$:

$$\begin{aligned} -z &= -1 \times z \\ &= (1 \operatorname{cis} \pi) \times (r \operatorname{cis} \theta) \\ &= r \operatorname{cis}(\pi + \theta) \end{aligned}$$

But $(\pi + \theta)$ will be outside the $-\pi$ to π requirement, so subtract 2π to give

$$\begin{aligned} -z &= r \operatorname{cis}(\pi + \theta - 2\pi) \\ &= r \operatorname{cis}(\theta - \pi), \quad \text{as before.} \end{aligned}$$

c If $z = r \operatorname{cis} \theta$
 $z^2 = (r \operatorname{cis} \theta)^2$
 $= r^2 \operatorname{cis}(2\theta)$ (by de Moivre's theorem).

Exercise 2F

- 1 Prove that de Moivre's theorem, $(\cos \theta + i \sin \theta)^n = \cos n\theta + i \sin n\theta$, is true for $n = -1$.
- 2 If $z = \cos \frac{\pi}{6} + i \sin \frac{\pi}{6}$ determine z^4 in exact polar form.
- 3 If $z = 2 \operatorname{cis} \frac{\pi}{6}$ determine z^5 in exact polar form.
- 4 If $z = 3 \left(\cos \frac{\pi}{3} + i \sin \frac{\pi}{3} \right)$ determine z^5 in exact polar form.
- 5 Use de Moivre's theorem to express $\cos 2\theta$ and $\sin 2\theta$ in terms of $\sin \theta$ and $\cos \theta$.
- 6 Use de Moivre's theorem to express $\cos 3\theta$ and $\sin 3\theta$ in terms of $\sin \theta$ and $\cos \theta$.
Hence determine $\cos 3\theta$ in terms of $\cos \theta$.
- 7 Use de Moivre's theorem to express $\cos 5\theta$ and $\sin 5\theta$ in terms of $\sin \theta$ and $\cos \theta$.

- 8** Use de Moivre's theorem to determine $(1 + i)^6$, giving your answer in exact polar form.
- 9** Use de Moivre's theorem to determine $(\sqrt{3} + i)^5$, giving your answer in exact polar form.
- 10** Use de Moivre's theorem to determine $(-3 + 3\sqrt{3}i)^4$, giving your answer in exact polar form.
- 11** Use de Moivre's theorem to determine the three cube roots of $(4 - 4\sqrt{3}i)$, giving your answers in exact polar form.
- 12** Use de Moivre's theorem to solve the equation $z^4 = 16i$, giving your answers in exact polar form.
- 13** Use de Moivre's theorem to solve the equation $z^4 = -8\sqrt{2} + 8\sqrt{2}i$, giving your answers in exact polar form.
- 14** Use de Moivre's theorem to solve the equation $z^4 + 4 = 0$, giving your answers in exact polar form.
- 15** Express z_1 and z_2 in exact polar form, where $z_1 = \frac{\sqrt{2} + i\sqrt{6}}{2}$, and $z_2 = \frac{\sqrt{6} + i\sqrt{2}}{2}$.

Hence simplify $\frac{z_1^6 z_2^3}{z_3^4}$ given that $z_3 = 2 \operatorname{cis} \frac{\pi}{8}$.

- 16** The complex number z is such that $z = r \operatorname{cis} \theta$, with $r > 0$ and $0 \leq \theta \leq \frac{\pi}{2}$.

Express each of the following in the form $a \operatorname{cis} \beta$ where $a > 0$ and $-\pi < \beta \leq \pi$.

a $-\bar{z}$

b $\frac{1}{z}$

c $-\frac{1}{z}$

d $-\frac{1}{z^2}$



Imagefolk/Fine Art Images

Abraham de Moivre (1667–1754)



Miscellaneous exercise two

This miscellaneous exercise may include questions involving the work of this chapter, the work of any previous chapters, and the ideas mentioned in the Preliminary work section at the beginning of the book.

- 1 If the complex numbers z and w are such that $z = 3 - 4i$
and $w = 2 + 3i$
express each of the following in the form $a + bi$.

a $z + w$

b $z - w$

c zw

d z^2

e $\frac{z}{w}$

f $\frac{w}{z}$

- 2 The diagram on the right shows the parallelogram OABC with $\vec{OA} = \mathbf{a}$
and $\vec{OC} = \mathbf{c}$.

D is a point on AB such that $AD:DB = 1:3$.

E is a point on AB produced such that $AB:BE = 2:1$.

Express each of the following in terms of \mathbf{a} and/or \mathbf{c} .

a \vec{AB}

b \vec{AD}

c \vec{DB}

d \vec{DE}

e \vec{OB}

f \vec{OD}

g \vec{CE}

h \vec{OE}

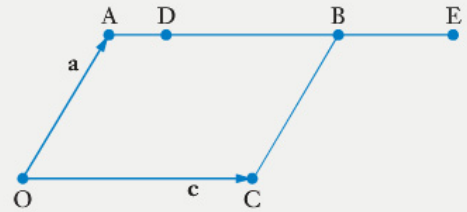

- 3 Express exactly
- a** $-3 - 3\sqrt{3}i$ in polar form,
b $8 \operatorname{cis}\left(-\frac{5\pi}{6}\right)$ in cartesian form.

- 4 Express each of the following in the form (a, b) where (a, b) represents the complex number $a + bi$.

a $2 \operatorname{cis}\left(\frac{\pi}{2}\right)$

b $5 \operatorname{cis} \pi$

c $4 \operatorname{cis}\left(-\frac{3\pi}{4}\right)$

- 5 If $z = 1 + i$ and $w = -1 + i$ express z , w , zw and $\frac{z}{w}$ in polar form.

- 6 With $\operatorname{cis} \theta$ defined as $\cos \theta + i \sin \theta$, where $i = \sqrt{-1}$, prove that:

a $\operatorname{cis} 0 = 1$

b $\operatorname{cis} \alpha \operatorname{cis} \beta = \operatorname{cis}(\alpha + \beta)$

- 7 (Without the assistance of your calculator.)

a For $f(x) = 4x^3 - 18x^2 + 22x - 12$, determine $f(-3)$ and $f(3)$.

b Determine all values for x , real and complex, for which $f(x) = 0$.

3.

Functions

- One-to-one and many-to-one
- Combining functions
- Using the output from one function as the input of another
- Domain and range of functions of the form $f \circ g(x)$
- Inverse functions
- Graphical relationship between a function and its inverse
- Condition for the inverse to exist as a function
- The absolute value function
- The absolute value of x as $\sqrt{x^2}$
- Solving equations involving absolute values
- Solving inequalities involving absolute values
- The graph of $y = \frac{1}{f(x)}$
- The graph of $y = \frac{f(x)}{g(x)}$ for $f(x)$ and $g(x)$ polynomials
- Absolute value – extension activity
- Rational functions – extension activity
- Miscellaneous exercise three

One-to-one and many-to-one

As the *Preliminary work* suggested, you should already be familiar with the idea that in mathematics, a rule that takes one element from one set and assigns to it one, *and only one*, element from a second set, is called a **function**. You should also be familiar with the associated terms **domain**, **natural domain** and **range**.

From your earlier studies you may also be familiar with the idea that a function may be **one-to-one**, or **many-to-one**. These terms, and a few others, are explained below.

In the function diagram shown on the right the **domain** is the set $\{a, b, c\}$.

We say that each element from the first set, the domain, **maps onto** an element of the second set, the **co-domain**, $\{d, e, f, g\}$. Those elements of the co-domain that the elements of the first set map onto, form the **range**, in this case $\{d, e, g\}$.

With each element of the domain mapped onto a different element of the range this function is said to be **one-to-one**.

Contrast the above situation with that shown in the new diagram on the right.

Now more than one element of the domain map onto the same element of the range. In this case $a \rightarrow d$ and $b \rightarrow d$.

We call such functions **many-to-one**.

One-to-many relationships can occur, as shown on the right, but under the requirement that a function takes one element from the domain and assigns to it one, *and only one*, element of the range, a one-to-many relationship would *not* be called a function.

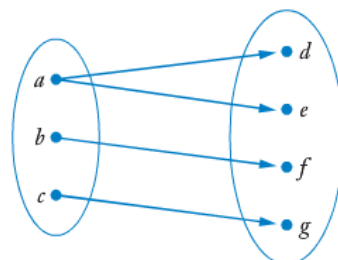
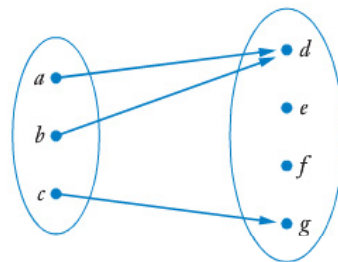
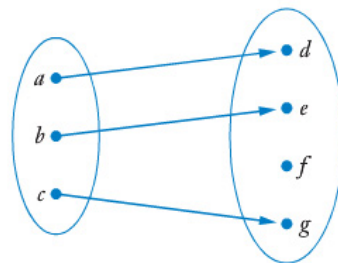

Note

Whilst the diagrams above show letters as the elements of the domain and range **the functions we will deal with in this chapter will have domains and ranges consisting only of real numbers**, i.e. numbers from \mathbb{R} , the set of real numbers.

Functions whose values are real numbers, are sometimes referred to as real-valued functions.



You should also be familiar with the fact that our requirement that a function takes one element from the domain and assigns to it one *and only one* element from the range, means that the graph of a function must be such that:

If a vertical line is moved from the left of the domain
to the right it must never cut the graph in more than one place.

This is called the **vertical line test**.

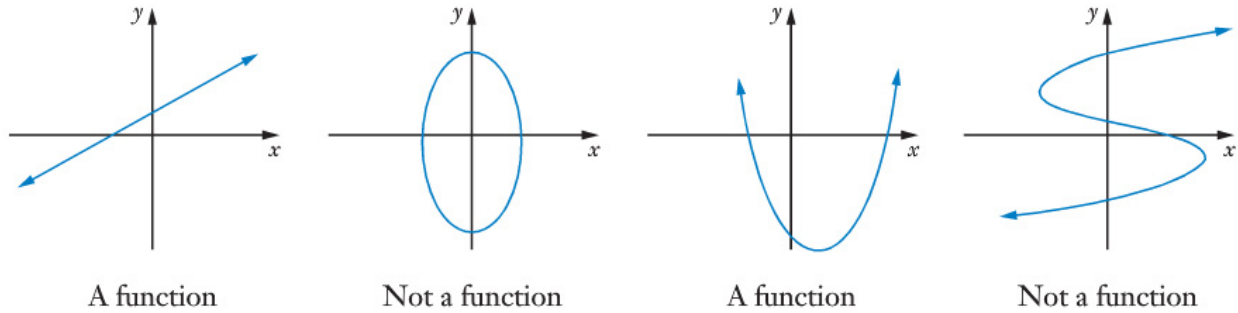

We could use a similar **horizontal line test** to determine whether a function is a one-to-one function or not. Thus of the two graphs shown above that show functions, only the first would pass the horizontal line test.

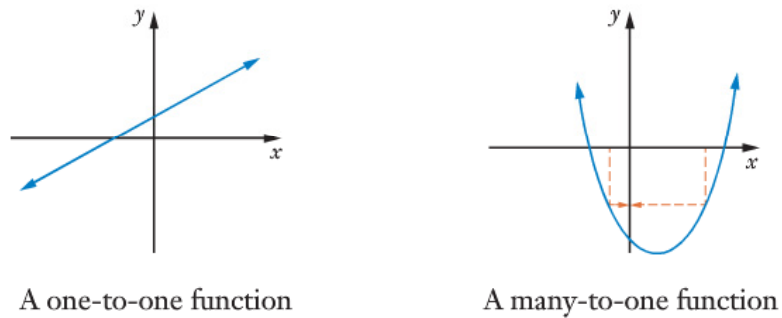

To be a one-to-one function the graph needs to pass both the vertical line test (to be a function), and the horizontal line test (to be one-to-one).

Combining functions

We can use the basic operations of +, −, × and ÷ to combine functions.

For example, if $f(x) = x + 1$ and $g(x) = x - 1$ then

$$\begin{aligned} f(x) + g(x) &= (x + 1) + (x - 1) \\ &= 2x \end{aligned}$$

$$\begin{aligned} f(x) - g(x) &= (x + 1) - (x - 1) \\ &= 2 \end{aligned}$$

$$\begin{aligned} f(x) \times g(x) &= (x + 1)(x - 1) \\ &= x^2 - 1 \end{aligned}$$

$$\begin{aligned} f(x) \div g(x) &= (x + 1) \div (x - 1) \\ &= \frac{x + 1}{x - 1} \end{aligned}$$

However we do have to be careful when considering the domain and range of each of these new functions formed by combining $f(x)$ and $g(x)$. The functions $f(x)$ and $g(x)$ defined on the previous page each have domain \mathbb{R} and range \mathbb{R} but this does not mean that the functions formed by combining $f(x)$ and $g(x)$ will necessarily have domain \mathbb{R} and range \mathbb{R} .

For example:

- $f(x) - g(x) = 2$ and therefore has range $\{y \in \mathbb{R}: y = 2\}$.

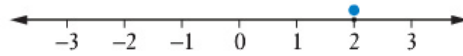

Remember

- Reading ' \in ' as 'is a member of', and ':' as 'such that', then $\{y \in \mathbb{R}: y = 2\}$ can be read as:
y is a member of the set of real numbers such that y equals 2.
- We could use any letter to define the range and the domain but we will tend to use x when defining a domain and y when defining a range.

- $f(x) \times g(x) = x^2 - 1$ and therefore has range $\{y \in \mathbb{R}: y \geq -1\}$. i.e:

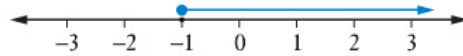

- $\frac{f(x)}{g(x)} = \frac{x+1}{x-1}$ is undefined for $x = 1$.

Thus $\frac{f(x)}{g(x)}$ does not exist as a function unless we restrict the domain of $g(x)$ to $\{x \in \mathbb{R}: x \neq 1\}$.

With this restriction in place $\frac{f(x)}{g(x)}$ does exist and has domain $\{x \in \mathbb{R}: x \neq 1\}$ and range $\{y \in \mathbb{R}: y \neq 1\}$.

The display of $y = \frac{x+1}{x-1}$ shown on the right suggests agreement with these facts. The function seems to have $x = 1$ as a vertical asymptote and $y = 1$ as a horizontal asymptote suggesting that the function can cope with x values close to 1, but not 1 itself, and it can output values close to 1, but not 1 itself.

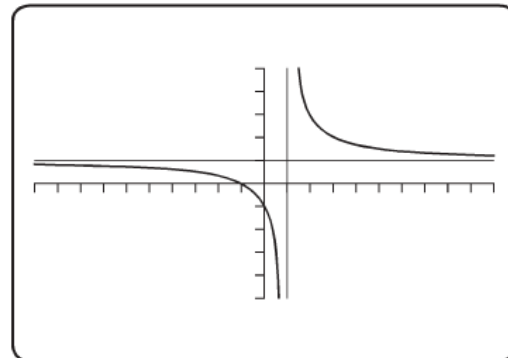

Using the output from one function as the input of another

The section in the *Preliminary work* on function mentioned the idea of using the output from one function as the input of a second function.

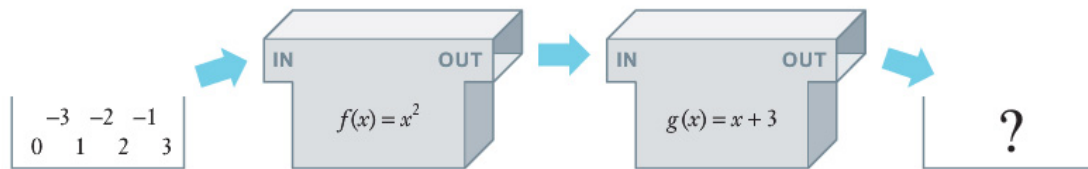

With the domain stated, combining the functions f and g in this way will give a final output of $\{3, 4, 7, 12\}$:

As the *Preliminary work* mentioned:

We write this combined function as $g[f(x)]$
 or as $g \circ f(x)$ or $g \circ f(x)$ for 'g of f of x'
 or as $gf(x)$,

and, though our 'machine diagram' above shows the 'f function' first, we write the combined function as $gf(x)$, to show that the 'f function', being closest to the '(x)', operates on the x values first.

EXAMPLE 1

With $f(x) = 2x - 3$, $g(x) = (x + 1)^2$ and with an initial domain of $\{0, 1, 2, 3, 4\}$, determine the range of

- a $gf(x)$,
- b $fg(x)$,
- c $gg(x)$.

Solution

$$\text{a } \{0, 1, 2, 3, 4\} \xrightarrow{f(x)} \{-3, -1, 1, 3, 5\} \xrightarrow{g(x)} \{0, 4, 16, 36\}$$

The range is $\{0, 4, 16, 36\}$.

$$\text{b } \{0, 1, 2, 3, 4\} \xrightarrow{g(x)} \{1, 4, 9, 16, 25\} \xrightarrow{f(x)} \{-1, 5, 15, 29, 47\}$$

The range is $\{-1, 5, 15, 29, 47\}$.

$$\text{c } \{0, 1, 2, 3, 4\} \xrightarrow{g(x)} \{1, 4, 9, 16, 25\} \xrightarrow{g(x)} \{4, 25, 100, 289, 676\}$$

The range is $\{4, 25, 100, 289, 676\}$.

EXAMPLE 2

Given that $f(x) = 3x - 2$, $g(x) = 2x + 1$ and $h(x) = x^2$ express each of the following functions in a similar way (i.e. in terms of x).

a $g \circ f(x)$ **b** $f \circ f(x)$ **c** $f \circ h(x)$ **d** $h \circ f(x)$

Solution

a $g \circ f(x) = g[f(x)]$
 $= g[3x - 2]$
 $= 2(3x - 2) + 1$
 $= 6x - 3$

b $f \circ f(x) = f[f(x)]$
 $= f[3x - 2]$
 $= 3(3x - 2) - 2$
 $= 9x - 8$

c $f \circ h(x) = f[h(x)]$
 $= f[x^2]$
 $= 3x^2 - 2$

d $h \circ f(x) = h[f(x)]$
 $= h[3x - 2]$
 $= (3x - 2)^2$

Domain and range of functions of the form $f \circ g(x)$

If we are not told a specific domain for a composite function we assume it to be the **natural** or **implied** domain, i.e. all the real numbers for which the composite function is defined. However care needs to be taken because the natural domain of $f[g(x)]$ may not simply be the natural domain of $g(x)$.

EXAMPLE 3

State the natural domain and the corresponding range of each of the following functions given that

$f(x) = x - 5$ and $g(x) = \frac{1}{x-1}$.

a $g \circ f(x)$, **b** $f \circ g(x)$.

Solution

a First identify the natural domain and range of $f(x)$ and $g(x)$.

$$\mathbb{R} \rightarrow \boxed{f(x) = x - 5} \rightarrow \mathbb{R} \qquad \{x \in \mathbb{R}: x \neq 1\} \rightarrow \boxed{g(x) = \frac{1}{x-1}} \rightarrow \{y \in \mathbb{R}: y \neq 0\}$$

For $g(x)$ to cope with the output from $f(x)$ we must ensure that the output does not include 1. Hence we must exclude 6 from the domain of $f(x)$.

Thus $g \circ f(x)$ has natural domain $\{x \in \mathbb{R}: x \neq 6\}$ and range $\{y \in \mathbb{R}: y \neq 0\}$.

b First identify the natural domain and range of $g(x)$ and $f(x)$.

$$\{x \in \mathbb{R}: x \neq 1\} \rightarrow \boxed{g(x) = \frac{1}{x-1}} \rightarrow \{y \in \mathbb{R}: y \neq 0\} \qquad \mathbb{R} \rightarrow \boxed{f(x) = x - 5} \rightarrow \mathbb{R}$$

$f(x)$ can cope with the output from $g(x)$ but note that 0 will not be in this output. Thus -5 will not be in the output from $f(x)$.

Thus $f \circ g(x)$ has natural domain $\{x \in \mathbb{R}: x \neq 1\}$ and range $\{y \in \mathbb{R}: y \neq -5\}$.



The displays below confirm these domains and ranges for the composite functions $g \circ f(x)$ and $f \circ g(x)$, with $f(x)$ and $g(x)$ as defined on the right.

I.e., $g \circ f(x)$ has natural domain $\{x \in \mathbb{R}: x \neq 6\}$
 and range $\{y \in \mathbb{R}: y \neq 0\}$.
 $f \circ g(x)$ has natural domain $\{x \in \mathbb{R}: x \neq 1\}$
 and range $\{y \in \mathbb{R}: y \neq -5\}$

Define $f(x) = x - 5$ done

Define $g(x) = \frac{1}{x-1}$ done

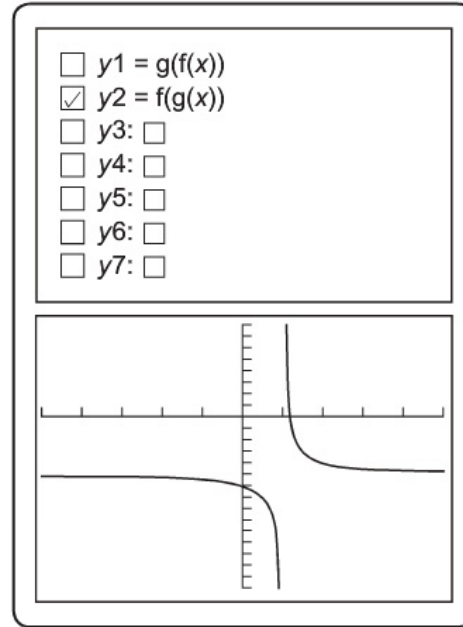
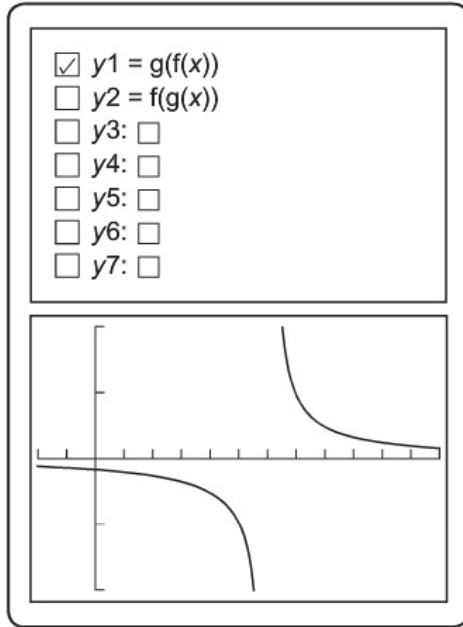

We could have approached the previous example by expressing each composite function in terms of x and determining the domain and range of the resulting expression:

<p>a $g \circ f(x) = g(x - 5)$ $= \frac{1}{(x - 5) - 1}$ $= \frac{1}{(x - 6)}$</p> <p>Domain $\{x \in \mathbb{R}: x \neq 6\}$ Range $\{y \in \mathbb{R}: y \neq 0\}$</p>	<p>b $f \circ g(x) = f\left(\frac{1}{x-1}\right)$ $= \frac{1}{x-1} - 5$</p> <p>Domain $\{x \in \mathbb{R}: x \neq 1\}$ Range $\{y \in \mathbb{R}: y \neq -5\}$</p>
---	---

However this approach must be used with caution. In some cases the fact that the final expression has come from a combination of functions means that the domain and range will not be the same as the final expression considered in isolation. The next example, in which

$$f(x) = \sqrt{x}, g(x) = x^2 \quad \text{and} \quad g \circ f(x) = g(\sqrt{x}) = x, \quad \text{is of this type.}$$



EXAMPLE 4

Determine the natural domain and the corresponding range of $g \circ f(x)$ given that

$$f(x) = \sqrt{x} \text{ and } g(x) = x^2.$$

Solution

First identify the natural domain and range of $f(x)$ and $g(x)$.

$$\{x \in \mathbb{R}: x \geq 0\} \rightarrow \boxed{f(x) = \sqrt{x}} \rightarrow \{y \in \mathbb{R}: y \geq 0\} \quad \mathbb{R} \rightarrow \boxed{g(x) = x^2} \rightarrow \{y \in \mathbb{R}: y \geq 0\}$$

$g(x)$ can cope with the output from $f(x)$ but note that the output from $g(x)$ consists of only the non-negative numbers.

Thus $g \circ f(x)$ has natural domain $\{x \in \mathbb{R}: x \geq 0\}$ and range $\{y \in \mathbb{R}: y \geq 0\}$.

The display below confirms this domain and range of $g \circ f(x)$ with $f(x) = \sqrt{x}$
and $g(x) = x^2$,
(and real values only).

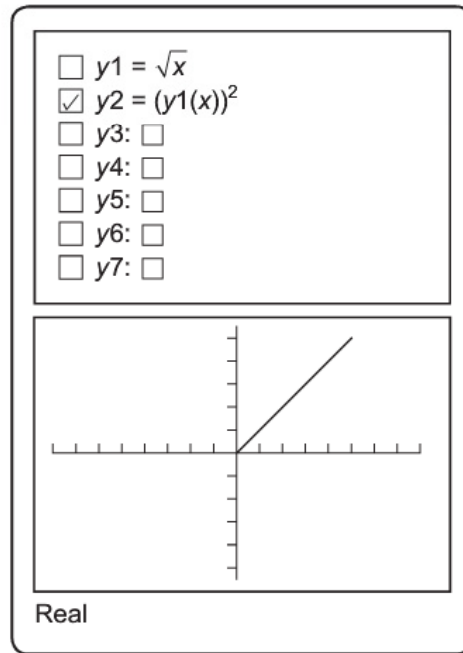

Note that for real values, this domain and range is not what we would have obtained had we wrongly considered $g \circ f(x)$ to be the same as $h(x) = x$ which has domain \mathbb{R} and range \mathbb{R} .



EXAMPLE 5

Given that $f(x) = 2x$ and $g(x) = \sqrt{x-2}$ explain why $f[g(x)]$ is a function for the natural domain of $g(x)$ whereas $g[f(x)]$ is not a function for the natural domain of $f(x)$.

Solution

$$\{x \in \mathbb{R}: x \geq 2\} \rightarrow \boxed{g(x) = \sqrt{x-2}} \rightarrow \{y \in \mathbb{R}: y \geq 0\} \quad \mathbb{R} \rightarrow \boxed{f(x) = 2x} \rightarrow \mathbb{R}$$

$f(x)$ can cope with all the numbers in the range of $g(x)$ because the range of $g(x)$ is contained within the domain of $f(x)$.

Thus $f[g(x)]$ is a function for the natural domain of $g(x)$.

$$\mathbb{R} \rightarrow \boxed{f(x) = 2x} \rightarrow \mathbb{R} \quad \{x \in \mathbb{R}: x \geq 2\} \rightarrow \boxed{g(x) = \sqrt{x-2}} \rightarrow \{y \in \mathbb{R}: y \geq 0\}$$

There are some numbers in the range of $f(x)$ that $g(x)$ will not be able to cope with. In this case the range of $f(x)$ contains elements that are outside the domain of $g(x)$.

Thus $g[f(x)]$ is not a function for the natural domain of $f(x)$.

Note: $g[f(x)]$ is a function if we restrict the domain of $f(x)$ to give an output that $g(x)$ can cope with.

Thus the natural domain of $g[f(x)]$ is $\{x \in \mathbb{R}: x \geq 1\}$ with corresponding range $\{y \in \mathbb{R}: y \geq 0\}$.

Exercise 3A

- With $f(x) = x + 1$, $g(x) = 2x - 3$ and with an initial domain of $\{0, 1, 2, 3, 4\}$, determine the range of
 - $gf(x)$,
 - $fg(x)$,
 - $gg(x)$.
- With $f(x) = x + 3$, $g(x) = (x - 1)^2$, $h(x) = x^3$, and with $\{1, 2, 3\}$ as the initial domain, determine the range of
 - $gf(x)$,
 - $fgh(x)$,
 - $hgf(x)$.
- If $f(x) = x + 5$ and $g(x) = x - 5$ determine the natural domain and range of each of the following.
 - $f(x)$
 - $g(x)$
 - $f(x) + g(x)$
 - $f(x) - g(x)$
 - $f(x) \cdot g(x)$
 - $\frac{f(x)}{g(x)}$

4 Given that $f(x) = 3x + 2$, $g(x) = \frac{2}{x}$ and $h(x) = \sqrt{x}$, express each of the following functions in terms of some or all of f , g and h .

a $\frac{2}{3x+2}$

b $\sqrt{3x+2}$

c $\frac{6}{x} + 2$

d $3\sqrt{x} + 2$

e $\frac{2}{\sqrt{x}}$

f $\sqrt{\frac{2}{x}}$

g $9x + 8$

h $x^{0.25}$

i $27x + 26$

5 Given that $f(x) = 2x - 3$, $g(x) = 4x + 1$ and $h(x) = x^2 + 1$, express each of the following functions in a similar way (i.e. in terms of x), simplifying where possible.

a $f \circ f(x)$

b $g \circ g(x)$

c $h \circ h(x)$

d $f \circ g(x)$

e $g \circ f(x)$

f $f \circ h(x)$

g $h \circ f(x)$

h $g \circ h(x)$

i $h \circ g(x)$

6 Given that $f(x) = 2x + 5$, $g(x) = 3x + 1$ and $h(x) = 1 + \frac{2}{x}$, express each of the following functions in a similar way (i.e. in terms of x), simplifying where possible.

a $f \circ f(x)$

b $g \circ g(x)$

c $h \circ h(x)$

d $f \circ g(x)$

e $g \circ f(x)$

f $f \circ h(x)$

g $h \circ f(x)$

h $g \circ h(x)$

i $h \circ g(x)$

For each of questions 7 to 12, $g[f(x)]$ is not a function for the natural domain of $f(x)$. State the minimal restriction necessary on the natural domain of $f(x)$ for $g[f(x)]$ to be defined for this domain.

7 $f(x) = x - 4$, $g(x) = \sqrt{x}$

8 $f(x) = 4 - x$, $g(x) = \sqrt{x}$

9 $f(x) = 4 - x^2$, $g(x) = \sqrt{x}$

10 $f(x) = 4 - |x|$, $g(x) = \sqrt{x}$

11 $f(x) = x + 3$, $g(x) = \sqrt{x - 5}$

12 $f(x) = x - 6$, $g(x) = \sqrt{x + 3}$

13 If $f(x) = x^2 + 3$ and $g(x) = \frac{1}{x}$ find:

a $f(3)$

b $f(-3)$

c $g(2)$

d $fg(1)$

e $gf(1)$

f the natural domain and corresponding range of f

g the natural domain and corresponding range of g

h the natural domain and corresponding range of $gf(x)$

(Check your answer using a graphic calculator with $Y1 = X^2 + 3$ and $Y2 = 1 \div Y1$.)

i the natural domain and corresponding range of $fg(x)$



14 If $f(x) = 25 - x^2$ and $g(x) = \sqrt{x}$ find:

- a** $f(5)$ **b** $f(-5)$ **c** $g(4)$ **d** $fg(4)$ **e** $gf(4)$
f the natural domain and corresponding range of f
g the natural domain and corresponding range of g
h the natural domain and corresponding range of $gf(x)$
i the natural domain and corresponding range of $fg(x)$

15 State the natural domain and the corresponding range of each of the following functions given

that $f(x) = x + 2$ and $g(x) = \frac{1}{x-3}$.

- a** $g \circ f(x)$ **b** $f \circ g(x)$

16 State the natural domain and the corresponding range of each of the following functions given

that $f(x) = \sqrt{x}$ and $g(x) = 2x - 1$.

- a** $g \circ f(x)$ **b** $f \circ g(x)$

17 State the natural domain and the corresponding range of each of the following functions given

that $f(x) = \frac{1}{x^2}$ and $g(x) = \sqrt{x}$.

- a** $g \circ f(x)$ **b** $f \circ g(x)$

18 Given that $f(x) = x + 3$ and $g(x) = \sqrt{x}$ explain why $f[g(x)]$ is a function for the natural domain of $g(x)$ whereas $g[f(x)]$ is not a function for the natural domain of $f(x)$.

19 Given that $f(x) = x + 3$ and $g(x) = \frac{1}{x-5}$ explain why $f[g(x)]$ is a function for the natural domain of $g(x)$ whereas $g[f(x)]$ is not a function for the natural domain of $f(x)$.

20 State the natural domain and the corresponding range of each of the following functions given

that $f(x) = x^2 - 9$ and $g(x) = \frac{1}{x}$.

- a** $g \circ f(x)$ **b** $f \circ g(x)$

Inverse functions

If a function $f(x)$ maps the domain $\{a, b, c\}$ onto the range $\{g, h, i\}$ such that

$$f(a) = g \qquad f(b) = h \qquad f(c) = i$$

then the inverse function, $f^{-1}(x)$, will map $\{d, e, f\}$ back to $\{a, b, c\}$ such that

$$f^{-1}(g) = a \qquad f^{-1}(h) = b \qquad f^{-1}(i) = c$$

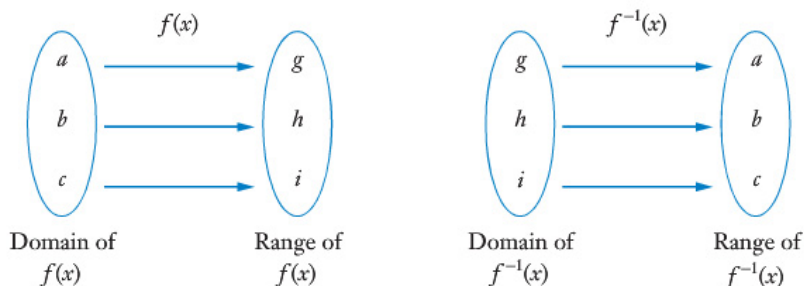

Thus **the range of $f(x)$ is the domain of $f^{-1}(x)$**
 and **the domain of $f(x)$ is the range of $f^{-1}(x)$.**

To determine the inverse of a function we can

- construct the function as a sequence of steps and then reverse the process: see method one in the next example,
- or
- rearrange the function rule: see method two in the next example.

EXAMPLE 6

Find the inverse of the function $f(x) = 2x + 3$.

Solution

Method One: Reversing the flow chart

Write the function as a flow chart with input x and output $2x + 3$.

$$x \rightarrow \boxed{\times 2} \rightarrow \boxed{+ 3} \rightarrow 2x + 3$$

Reverse the flow chart, writing the inverse of each operation.

$$\leftarrow \boxed{\div 2} \leftarrow \boxed{- 3} \leftarrow$$

For an input of x this reversed flow chart will output the inverse function.

$$\frac{x-3}{2} \leftarrow \boxed{\div 2} \leftarrow \boxed{- 3} \leftarrow x$$

Thus $f^{-1}(x) = \frac{x-3}{2}$. [Check: $f(5) = 13, f^{-1}(13) = 5$.]



Method Two: Rearranging the formula

If $y = 2x + 3$

$$y - 3 = 2x$$

and so $x = \frac{y-3}{2}$

Thus given y we can output x using $x = \frac{y-3}{2}$

$$\therefore f^{-1}(x) = \frac{x-3}{2}$$

solve($y = 2x + 3, x$)

$$\left\{ x = \frac{y-3}{2} \right\}$$

EXAMPLE 7

Find the inverse of the function $f(x) = 1 + \frac{1}{3+x}$

Solution

Method One: Reversing the flow chart

Write the function as a flow chart with input x and output $1 + \frac{1}{3+x}$.

$$x \rightarrow \boxed{+3} \rightarrow \boxed{\text{Invert}} \rightarrow \boxed{+1} \rightarrow \frac{1}{x+3} + 1$$

Reverse the flow chart, writing the inverse of each operation.

$$\leftarrow \boxed{-3} \leftarrow \boxed{\text{Invert}} \leftarrow \boxed{-1} \leftarrow$$

For an input of x this reversed flow chart will output the inverse function.

$$\frac{1}{x-1} - 3 \leftarrow \boxed{-3} \leftarrow \boxed{\text{Invert}} \leftarrow \boxed{-1} \leftarrow x$$

Thus $f^{-1}(x) = \frac{1}{x-1} - 3$. [Check: $f(2) = 1.2, f^{-1}(1.2) = 2$.]

Method Two: Rearranging the formula

If $y = 1 + \frac{1}{3+x}$

then $y - 1 = \frac{1}{3+x}$

$$3+x = \frac{1}{y-1}$$

$$x = \frac{1}{y-1} - 3$$

Thus given y we can output x using $x = \frac{1}{y-1} - 3$

$$\therefore f^{-1}(x) = \frac{1}{x-1} - 3$$

solve($y = 1 + \frac{1}{3+x}, x$)

$$\left\{ x = \frac{-3 \cdot y + 4}{y-1} \right\}$$

Graphical relationship between a function and its inverse

Consider some function $f(x)$ and its inverse function $f^{-1}(x)$.

For every point (a, b) that exists on the graph of $y = f(x)$ there will exist a point (b, a) on the graph of $y = f^{-1}(x)$.

Thus the graph of $y = f^{-1}(x)$ will be that of $y = f(x)$ reflected in the line $y = x$.

This is illustrated below for the functions of the previous two examples:

$$f(x) = 2x + 3, f^{-1}(x) = \frac{x-3}{2}$$

$$\text{and } g(x) = 1 + \frac{1}{3+x}, g^{-1}(x) = \frac{1}{x-1} - 3.$$

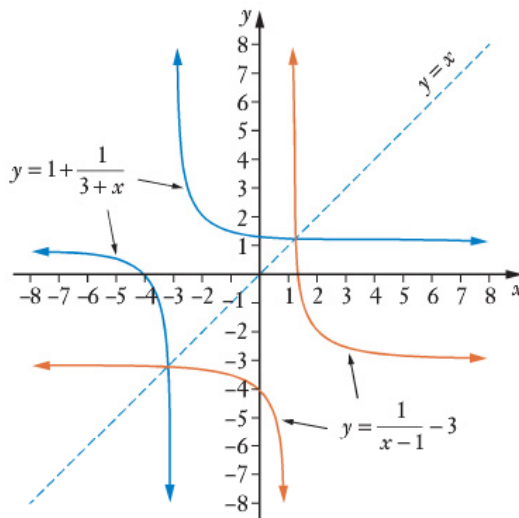
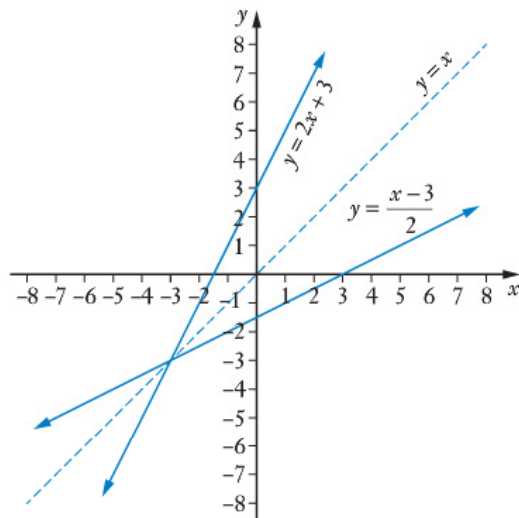

Condition for the inverse to exist as a function

Under our requirement that a function maps each element of the domain onto one and only one element of the range it follows that only one-to-one functions can have inverses that are functions.

Thus for $f(x)$ to have an inverse that is a function, the graph of $y = f(x)$ must pass the horizontal line test.

If the graph of the function is such that any horizontal line placed on the graph cuts the function no more than once, the function will be one-to-one and will therefore have an inverse function.

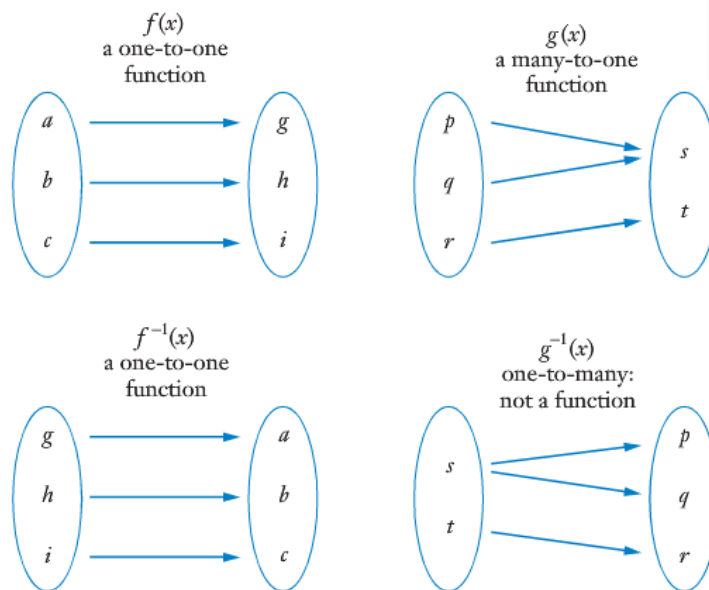

EXAMPLE 8

If $f(x) = \frac{1}{x+2}$ state whether the inverse function, $f^{-1}(x)$, exists. If it does exist, determine a formula for $f^{-1}(x)$ and state its domain and range.

Solution

First view the graph of the function.

$f(x)$ passes the horizontal line test and is therefore one-to-one for its natural domain $\{x \in \mathbb{R}: x \neq -2\}$, and has range $\{y \in \mathbb{R}: y \neq 0\}$.

Thus $f^{-1}(x)$ exists and has domain given by $\{x \in \mathbb{R}: x \neq 0\}$ and range $\{y \in \mathbb{R}: y \neq -2\}$.

$$\text{If } y = \frac{1}{x+2} \quad \text{then} \quad x = \frac{1}{y} - 2$$

$$\therefore f^{-1}(x) = \frac{1}{x} - 2. \quad \text{Domain } \{x \in \mathbb{R}: x \neq 0\} \\ \text{and range } \{y \in \mathbb{R}: y \neq -2\}.$$

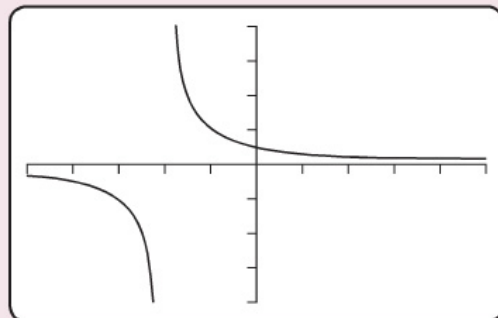

Note

Some calculators can display the inverse relationship automatically. See if your calculator can, and if so use it to confirm the domain and range for the above example.

However care needs to be taken in interpreting the display as being the inverse *function*. Some calculators display the inverse relationship and this may not itself be a function.

EXAMPLE 9

If $f(x) = \sqrt{x-5}$ determine whether the inverse function, $f^{-1}(x)$, exists. If it does exist, determine a formula for $f^{-1}(x)$ and state its domain and range.

Solution

First view the graph of the function.

$f(x)$ passes the horizontal line test and is therefore one-to-one for its natural domain, $\{x \in \mathbb{R}: x \geq 5\}$ and has range $\{y \in \mathbb{R}: y \geq 0\}$.

Thus $f^{-1}(x)$ exists and has domain given by $\{x \in \mathbb{R}: x \geq 0\}$ and range $\{y \in \mathbb{R}: y \geq 5\}$.

$$\text{If } y = \sqrt{x-5} \quad \text{then} \quad x = y^2 + 5$$

$$\therefore f^{-1}(x) = x^2 + 5. \quad \text{Domain } \{x \in \mathbb{R}: x \geq 0\} \text{ and range } \{y \in \mathbb{R}: y \geq 5\}.$$

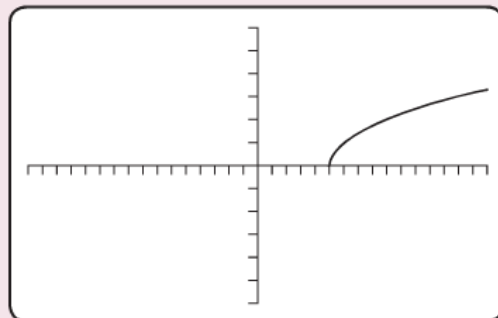

If a function is not one-to-one we can restrict the domain of the function to one in which the function is one-to-one and then an inverse function can exist.

EXAMPLE 10

The function $f(x)$ is defined by $f(x) = (x - 1)^2$.

- a** Explain why $f(x)$ cannot have an inverse function for its natural domain.
- b** State a suitable restriction for the domain of $f(x)$ so that, with this restriction applied, $f(x)$ can have an inverse function.
- c** Determine this inverse function and state its domain and range.

Solution

- a** First view the graph of the function.

$f(x)$ has natural domain \mathbb{R} and range $\{y \in \mathbb{R}: y \geq 0\}$.

The function is not one-to-one for this domain.

e.g. $f(0) = 1$ and $f(2) = 1$.

Thus $f(x)$ cannot have an inverse function for its natural domain.

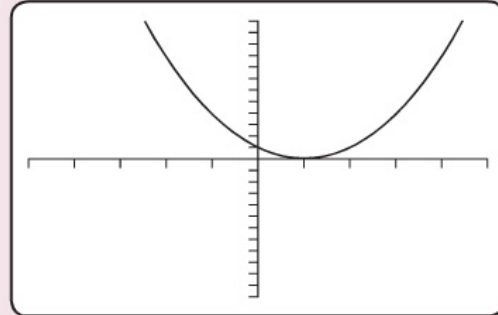

- b** If we restrict the domain of $f(x)$ to $x \geq 1$, or $x \leq 1$, the function is one-to-one. Thus either of these would be suitable restrictions on the domain.

- c** If $y = (x - 1)^2$ then $\pm\sqrt{y} = x - 1$
 $\therefore x = 1 \pm \sqrt{y}$

Thus the inverse function $f^{-1}(x)$ will be either $1 + \sqrt{x}$ or $1 - \sqrt{x}$.

For $f(x) = (x - 1)^2$, with domain $\{x \in \mathbb{R}: x \geq 1\}$ range $\{y \in \mathbb{R}: y \geq 0\}$

$f^{-1}(x) = ???$ with domain $\{x \in \mathbb{R}: x \geq 0\}$ range $\{y \in \mathbb{R}: y \geq 1\}$

For the given range it follows that $???$ must be $1 + \sqrt{x}$ not $1 - \sqrt{x}$.

(This also follows if we consider the reflection of $f(x)$, $x \geq 1$, in $y = x$.)

Thus $f^{-1}(x) = 1 + \sqrt{x}$ with domain $\{x \in \mathbb{R}: x \geq 0\}$ range $\{y \in \mathbb{R}: y \geq 1\}$

Alternatively:

For $f(x) = (x - 1)^2$, with domain $\{x \in \mathbb{R}: x \leq 1\}$ range $\{y \in \mathbb{R}: y \geq 0\}$

$f^{-1}(x) = 1 - \sqrt{x}$ with domain $\{x \in \mathbb{R}: x \geq 0\}$ range $\{y \in \mathbb{R}: y \leq 1\}$.

Exercise 3B

1 Which of the following functions have inverse functions on their natural domains?

a $f(x) = x$

b $f(x) = 2x + 3$

c $f(x) = 5x - 3$

d $f(x) = x^2$

e $f(x) = (2x - 1)^2$

f $f(x) = x^2 + 4$

g $f(x) = \frac{1}{x}$

h $f(x) = \frac{1}{x-3}$

i $f(x) = \frac{1}{x^2}$

Find an expression for the inverse function of each of the following and state its domain and range.

2 $f(x) = x - 2$

3 $f(x) = 2x - 5$

4 $f(x) = 5x + 2$

5 $f(x) = \frac{1}{x-4}$

6 $f(x) = \frac{1}{x+3}$

7 $f(x) = \frac{1}{2x-5}$

8 $f(x) = 1 + \frac{1}{2+x}$

9 $f(x) = 3 - \frac{1}{x-1}$

10 $f(x) = 4 + \frac{2}{2x-1}$

11 $f(x) = \sqrt{x}$

12 $f(x) = \sqrt{x+1}$

13 $f(x) = \sqrt{2x-3}$

Given that $f(x) = 2x + 5$, $g(x) = 3x + 1$ and $h(x) = 1 + \frac{2}{x}$ express each of the following functions in this form (i.e. as expressions in terms of x).

14 $f^{-1}(x)$

15 $g^{-1}(x)$

16 $h^{-1}(x)$

17 $f \circ f^{-1}(x)$

18 $f^{-1} \circ f(x)$

19 $f \circ h^{-1}(x)$

20 $(f \circ g)^{-1}(x)$

21 $g^{-1} \circ f^{-1}(x)$

22 $f \circ g^{-1}(x)$

23 For each of the following state whether the graph shown is a function.

For those that are functions state whether they are one-to-one or not.

For those that are one-to-one functions copy the diagram and add the graph of the inverse function.

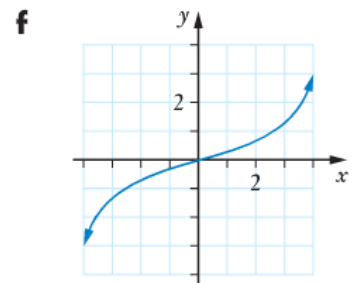
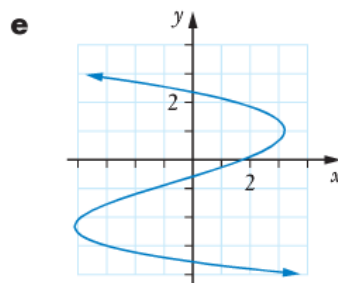
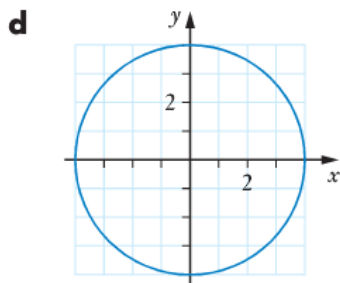
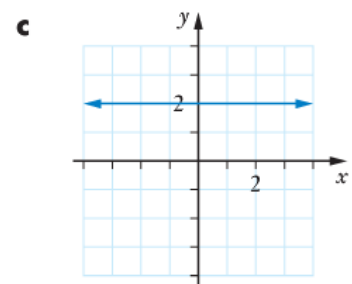
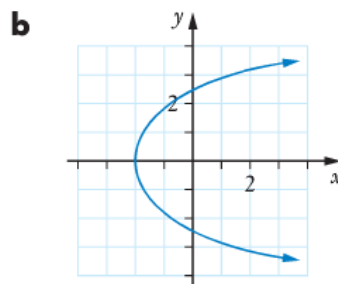
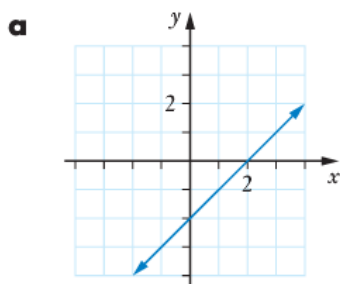

Each of questions **24** to **27** shows the graph of a function.

For each one, state a suitable restriction to the domain of $f(x)$ so $f^{-1}(x)$ exists as a function (do not restrict the domain any more than is necessary) and state the inverse function together with its domain and range.

24 $f(x) = x^2 + 3$

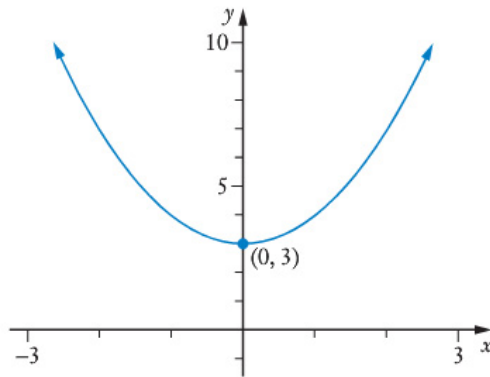

25 $f(x) = (x + 3)^2$

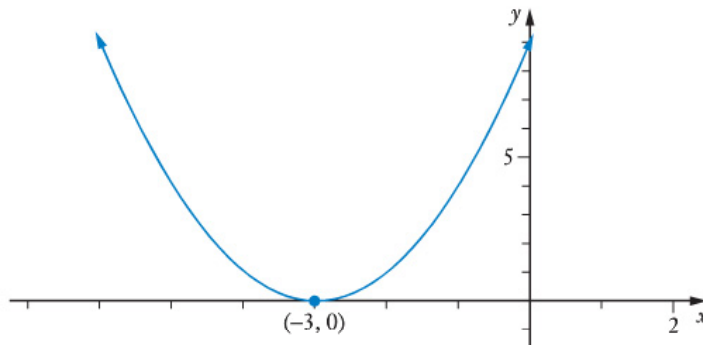

26 $f(x) = (x - 3)^2 + 2$

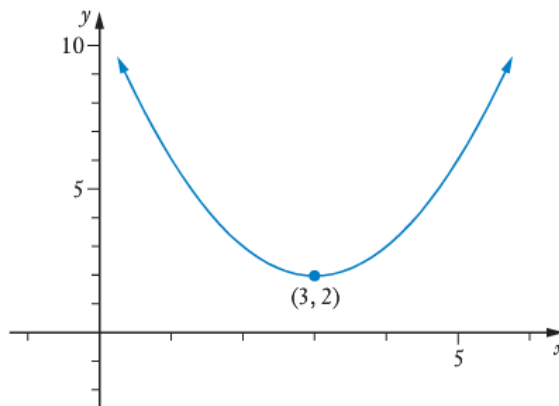

27 $f(x) = \sqrt{4 - x^2}$

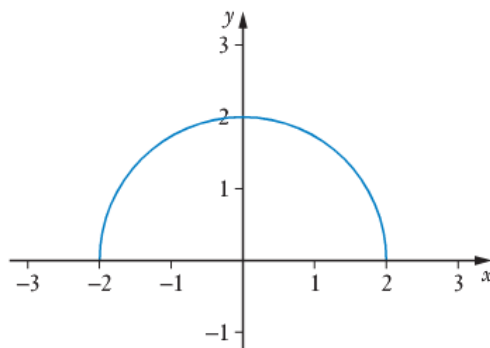

The absolute value function

Consider the function $f(x)$ shown on the right.

Suppose we want to graph $y = |f(x)|$

Wherever $f(x) \geq 0$ then $|f(x)| = f(x)$

So, any part of the graph of $f(x)$ that lies above the x -axis will also feature on the graph of $|f(x)|$.

Any part lying below the x -axis indicates that $f(x)$ is negative for these x values. Taking the absolute value will make these values positive, i.e. taking the absolute value of $f(x)$ will reflect, in the x -axis, any parts of $f(x)$ lying below the x -axis.

Hence the graph of $y = |f(x)|$ will be as shown on the right.

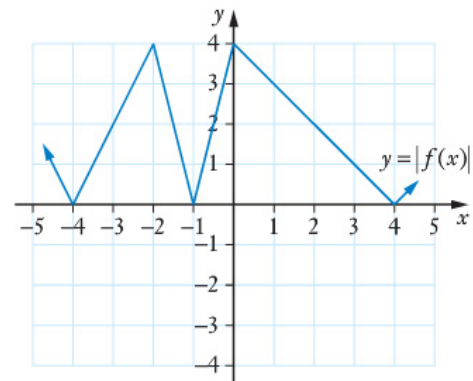
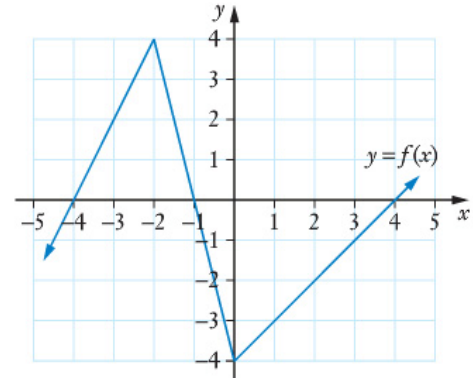

Similar considerations of the graphs of $y = x$ and $y = x^2 - 4$, for example, allow us to draw the graphs of $y = |x|$ and $y = |x^2 - 4|$, as shown below.

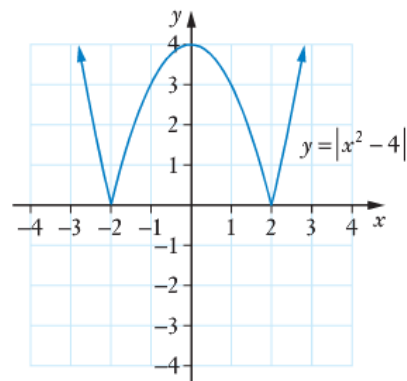
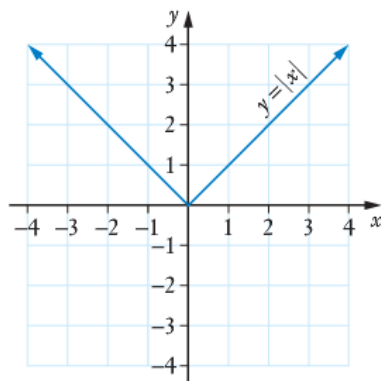
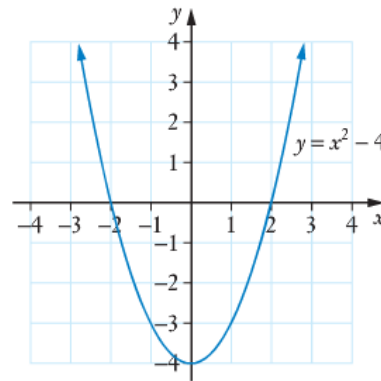
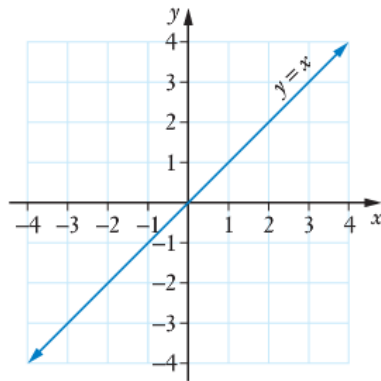

The absolute value of x as $\sqrt{x^2}$

Earlier in this chapter, when considering using the output from one function as the input of another function, we considered the composite function $g[f(x)]$ for $f(x) = \sqrt{x}$ and $g(x) = x^2$.

We found that $g[f(x)]$ has natural domain $\{x \in \mathbb{R}: x \geq 0\}$ and range $\{y \in \mathbb{R}: y \geq 0\}$.

Now let us instead consider $f[g(x)]$, for these same two functions.

First identify the natural domain and range of $g(x)$ and $f(x)$.

$$\mathbb{R} \rightarrow \boxed{g(x) = x^2} \rightarrow \{y \in \mathbb{R}: y \geq 0\} \quad \{x \in \mathbb{R}: x \geq 0\} \rightarrow \boxed{f(x) = \sqrt{x}} \rightarrow \{y \in \mathbb{R}: y \geq 0\}$$

$f(x)$ can cope with the output from $g(x)$ but note that the output from $f(x)$ consists of only the non negative numbers.

Thus $f[g(x)]$ has natural domain \mathbb{R} and range $\{y \in \mathbb{R}: y \geq 0\}$.

$$\begin{aligned} \text{Formulating an algebraic rule for } f[g(x)]: \quad f[g(x)] &= f[x^2] \\ &= \sqrt{x^2} \\ &= \begin{cases} x & \text{for } x \geq 0 \\ -x & \text{for } x \leq 0. \end{cases} \\ &= |x| \end{aligned}$$

EXAMPLE 11

If $f(x) = \sqrt{x} + 3$ and $g(x) = (x + 1)^2$, draw the graph of $f[g(x)]$.

Solution

$$\begin{aligned} f[g(x)] &= f[(x + 1)^2] \\ &= \sqrt{(x + 1)^2} + 3 \\ &= |x + 1| + 3 \end{aligned}$$

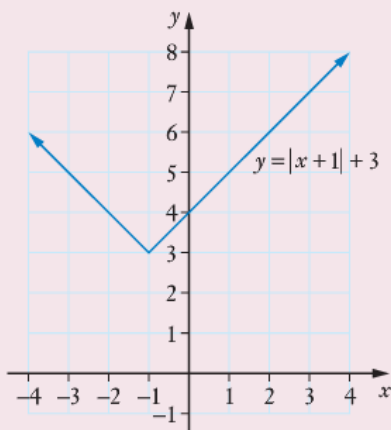

$y1 = (x + 1)^2$
 $y2 = \sqrt{y1(x)} + 3$
 $y3: \square$
 $y4: \square$
 $y5: \square$
 $y6: \square$
 $y7: \square$

Solving equations involving absolute values

The *Preliminary work* section at the beginning of this book reminded us that the absolute value of a number x , written $|x|$, is the distance the number is from the origin. For example:

$|5|$ is the distance from the point 5 to the origin, i.e. 5.



$|-3|$ is the distance from the point -3 to the origin, i.e. 3.

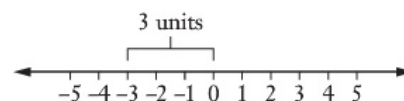

Similarly $|x - a|$ tells us the distance x is from the point a .

For example:

$|(5) - (3)|$ is the distance from the point 5 to the point 3, i.e. 2.

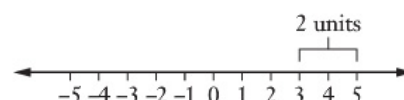

$|(5) + (3)|$, i.e. $|(5) - (-3)|$, is the distance from the point 5 to the point -3 . i.e. 8.

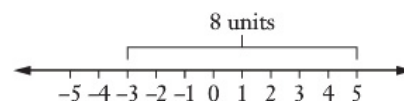

- Note
- If $|x| = a$ ($a \geq 0$), then x is a units from the origin.
 Thus either $x = a$
 or $x = -a$
 - If $|x| = |y|$ then x and y are equidistant from the origin.
 Thus either $x = y$
 or $x = -y$

Asked to solve equations like $|x + 2| = 5$ or $|x - 2| = |x + 6|$, without the assistance of a calculator, we could proceed in a number of ways:

- Algebraically
- Using the number line
- Graphically

Note

Whilst the syllabus for this unit does not specifically mention solving equations involving absolute value functions, the topic is included here to further an understanding of the graphs of absolute value functions and to meet the syllabus requirement of being able to use and apply the absolute value of a real number.



EXAMPLE 12

Determine the values of x for which $|x + 2| = 5$.

Solution

Algebraically

$$\begin{array}{l} \text{Either} \quad x + 2 = 5 \quad \text{or} \quad x + 2 = -5 \\ \therefore \quad x = 3 \quad \text{or} \quad x = -7 \end{array}$$

The required values are $x = -7$ and $x = 3$.

Using the number line

$$\begin{array}{l} |x + 2| = 5 \\ \text{i.e.} \quad |x - (-2)| = 5. \end{array}$$

Thus x is 5 units from -2 .

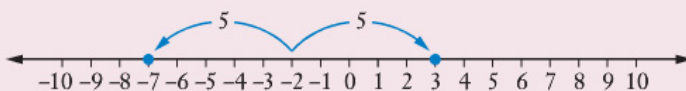

The required values are $x = -7$ and $x = 3$.

Graphically

Given the graphs of $y = |x + 2|$
and $y = 5$
the intersection of these lines is where $|x + 2| = 5$

The required values are $x = -7$ and $x = 3$.

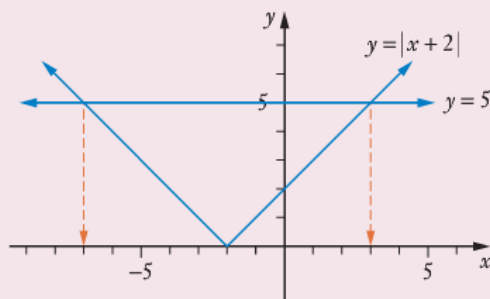

The values determined above can be confirmed using the ability of some calculators to solve equations involving absolute values.

$$\text{solve}(|x + 2| = 5, x)$$

$$\{x = -7, x = 3\}$$

EXAMPLE 13

Solve $|x - 2| = |x + 6|$.

Solution

Algebraically

$$\begin{array}{llll} \text{Either} & (x - 2) = (x + 6) & \text{or} & (x - 2) = -(x + 6) \\ \therefore & -2 = 6 & \text{or} & x - 2 = -x - 6 \\ & \text{No solution} & \text{or} & x = -2 \end{array}$$

The only solution is $x = -2$.

Alternatively, squaring both sides of the equation:

$$\begin{aligned} (x - 2)^2 &= (x + 6)^2 \\ x^2 - 4x + 4 &= x^2 + 12x + 36 \\ -16x &= 32 \\ \text{i.e.} & \quad x = -2 \end{aligned}$$

Check: If $x = -2$ then $|x - 2| = 4$
and $|x + 6| = 4$, as required. (See note below.)

Note: The final check is necessary because squaring both sides of an equation can introduce 'false' solutions.

For example consider the equation $x = 2$.

Squaring gives $x^2 = 4$
which has solutions $x = \pm 2$.

However -2 is clearly not a solution to the equation $x = 2$.

Thus if the technique of 'squaring both sides' is used the validity of the solutions must be checked.

Using the number line

$$\begin{array}{l} |x - 2| = |x + 6| \\ \text{i.e.} \quad |x - 2| = |x - (-6)|. \end{array}$$

The distance from x to the point 2 is the same as from x to the point -6 .

Thus x must be midway between -6 and 2.

The only solution is $x = -2$.

Graphically

Considering the graphs of $y = |x - 2|$
and $y = |x + 6|$
the intersection of these lines is where $|x - 2| = |x + 6|$

The only solution is $x = -2$.

- Again the solution obtained above can be confirmed using the solve facility of some calculators.

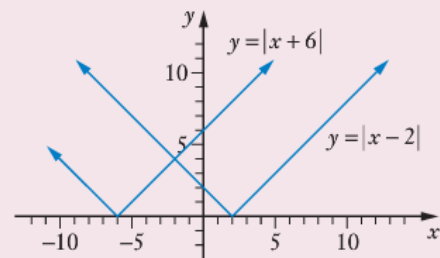

Some equations involving absolute values, e.g. $|x - 2| = 2x - 7$, can be difficult to interpret from the idea of distances on a number line. These equations can also need special care if an algebraic approach is used. Indeed if we have to demonstrate our ability to solve such equations without simply using the solve facility on a calculator, the graphical approach is probably the one least likely to cause errors. It may not be the quickest method but you will probably reduce the number of errors you are likely to make. In the next example, algebraic and graphical approaches are shown.

EXAMPLE 14

Determine the values of x for which $|x - 2| = 2x - 7$.

Solution

Algebraically

- We could proceed as in example 13 and then check that the apparent solutions are valid:

$$\begin{array}{l} x - 2 = 2x - 7 \quad \text{or} \quad -(x - 2) = 2x - 7 \\ \therefore \quad 5 = x \quad \text{or} \quad x = 3 \\ \text{Check: } |5 - 2| = 2(5) - 7 \quad |3 - 2| \neq 2(3) - 7 \end{array}$$

The only solution is $x = 5$.

- We could square both sides:

$$\begin{array}{l} (x - 2)^2 = (2x - 7)^2 \\ x^2 - 4x + 4 = 4x^2 - 28x + 49 \\ 0 = 3x^2 - 24x + 45 \\ \text{i.e.} \quad x^2 - 8x + 15 = 0 \\ \text{Giving} \quad x = 3 \quad \text{or} \quad x = 5 \\ \text{Check: } |3 - 2| \neq 2(3) - 7 \quad |5 - 2| = 2(5) - 7 \end{array}$$

The only solution is $x = 5$.

- Alternatively we could consider intervals of the number line separately:

<p>If $x \geq 2$: $x - 2 = 2x - 7$ $x = 5$ This is consistent with $x \geq 2$ $\therefore x = 5$</p>	<p>If $x < 2$: $-(x - 2) = 2x - 7$ $x = 3$ This is inconsistent with $x < 2$ $\therefore x \neq 3$</p>
---	---

The only solution is $x = 5$.

Graphically

Consider the graphs of $y = |x - 2|$
 and $y = 2x - 7$
 and determine their point of intersection.

The only solution is $x = 5$.

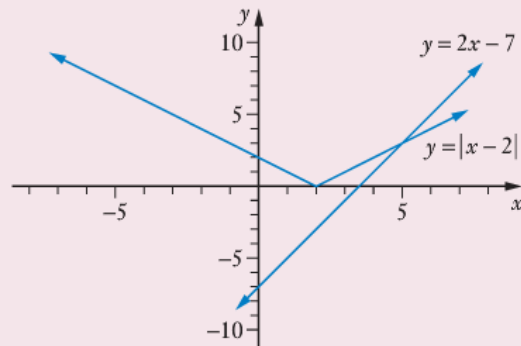



Solving inequalities involving absolute values

Check that you understand each of the following ideas.

- If $|x| < c, c > 0$, then the distance from x to the origin is less than c ,

$$\therefore -c < x < c$$

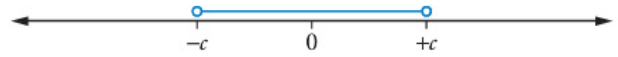

- If $|x| > c, c > 0$, then the distance from x to the origin is greater than c ,

$$\therefore \text{either } x < -c \text{ or } x > c$$

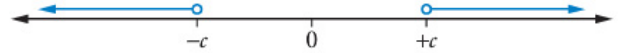

- If $|x - a| < c, c > 0$, then the distance from x to the point a is less than c ,

$$\therefore -c < (x - a) < c$$

$$\text{i.e. } a - c < x < a + c$$

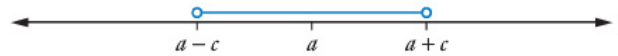

As we did when solving *equations* involving absolute values, we will consider three ways of solving *inequalities* involving absolute values (other than using the solve facility of some calculators):

- Algebraic
- Using the number line
- Graphical

The following examples demonstrate these methods of solution.

You are encouraged to also explore the capability of your calculator to solve inequalities involving absolute values.

EXAMPLE 15

Determine the values of x for which $|x| > 4$.

Solution

Algebraically

If $|x| > 4$ then either $x > 4$ or $x < -4$.

Thus the values of x are as shown:

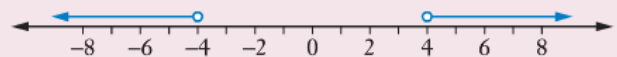

This would be written: $x < -4, x > 4$

or, using set notation: $\{x \in \mathbb{R}: x < -4\} \cup \{x \in \mathbb{R}: x > 4\}$

where the symbol \cup means the two sets are *united* to give the complete set of values.

Using the number line

If $|x| > 4$ then x is more than 4 units from the origin.

Thus once again the values of x are:

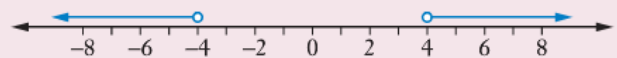

Graphically

View the graphs of

$$y = |x| \quad \text{and} \quad y = 4$$

and determine the values of x for which the graph of $y = |x|$ lies 'above' that of $y = 4$.

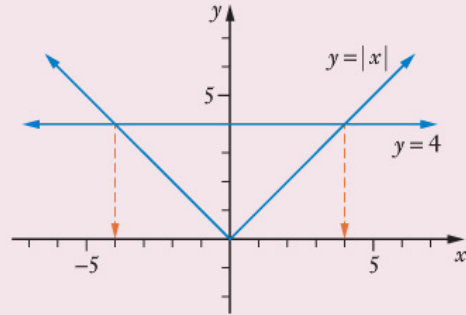

Again the values of x are:

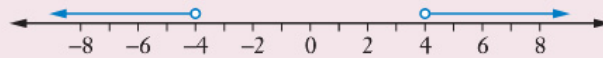

EXAMPLE 16

Determine the values of x for which $|x - 2| \leq 5$.

Solution

Algebraically

$$\begin{aligned} \text{If } |x - 2| \leq 5 \quad \text{then} \quad & -5 \leq x - 2 \leq 5 \\ \therefore \quad & -5 + 2 \leq x \leq 5 + 2 \\ \text{i.e.} \quad & -3 \leq x \leq 7 \end{aligned}$$

Using the number line

If $|x - 2| \leq 5$ then the distance from x to 2 is less than or equal to 5 units.

Thus the values of x are as shown:

i.e. $-3 \leq x \leq 7$, as before.

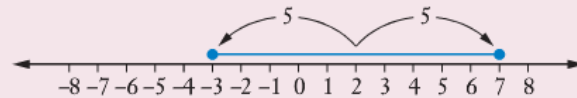

Graphically

Consider the graphs of $y = |x - 2|$
and $y = 5$

and determine the values of x for which the graph of $y = |x - 2|$ lies 'below' that of $y = 5$.

Thus again $-3 \leq x \leq 7$.

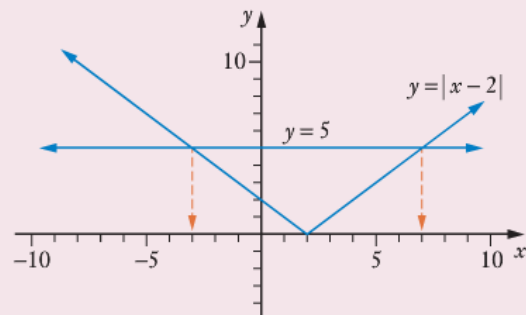

EXAMPLE 17

Show the graphs of $y = |2x - 4|$
and $y = |x - 5|$
on the same set of axes.

Hence determine the values of x for which $|2x - 4| \geq |x - 5|$.

Solution

The graphs of $y = |2x - 4|$
and $y = |x - 5|$
are shown on the right.

Looking for where the graph of $y = |2x - 4|$
is 'above' the graph of $y = |x - 5|$
we see that the inequality is true for:

$$x \leq -1 \text{ and for } x \geq 3.$$

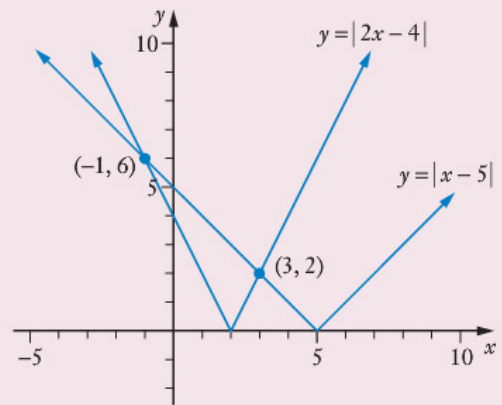

Exercise 3C

- (Use an x -axis from -5 to 5 .)
On graph paper, or squared paper, draw the graph of $y = |x + 1|$.
- (Use an x -axis from -3 to 6 .)
On graph paper, or squared paper, draw the graph of $y = |2x - 2|$.
- (Use an x -axis from -3 to 7 .)
On graph paper, or squared paper, draw the graphs of $y = |x - 2|$ and $y = 3 + |x - 2|$.
- (Use an x -axis from -2 to 4 .)
On graph paper, or squared paper, draw the graph of $y = |(x - 2)^2 - 1|$.
- The graph of $y = f(x)$ is shown on the right.
Draw the graph of $y = |f(x)|$.

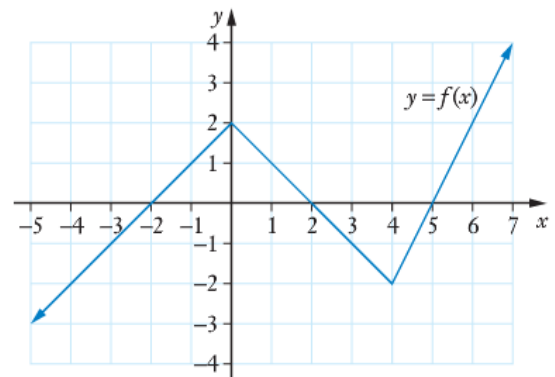

6 (Use an x -axis from -3 to 5 .)

For this question draw all three graphs on the same set of axes.

- a** Draw the graph of $y = |x|$.
- b** Draw the graph of $y = |x - 3|$.
- c** Hence draw the graph of $y = |x| + |x - 3|$.

7 The graph of $y = f(x)$ is shown on the right.

Draw the graph of each of the following.

- a** $y = |f(x)|$
- b** $y = f(|x|)$

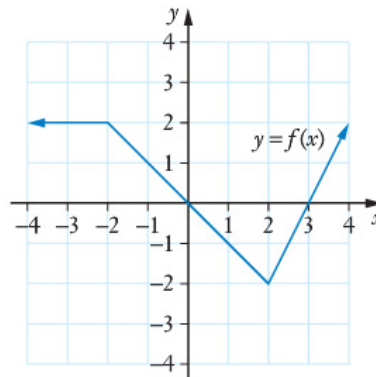

8 The graph of $y = f(x)$ is shown on the right.

Draw the graph of each of the following.

- a** $y = |f(x)|$
- b** $y = f(|x|)$

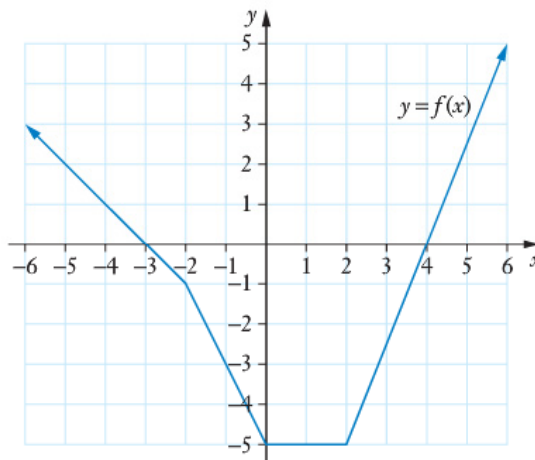

9 How will the graph of $y = g(|x|)$ relate to the graph of $y = g(x)$?

10 For this question $f(x) = 2 + \sqrt{x}$ and $g(x) = (x + 1)^2$.

- a** Explain why $f[g(x)]$ is defined for all real x , and state the corresponding range.
- b** Obtain an expression for $f[g(x)]$ in terms of x .
- c** Draw the graph of the composite function $f[g(x)]$.

11 For this question $f(x) = 1 - \sqrt{x}$ and $g(x) = (x - 2)^2$.

- a** Explain why $f[g(x)]$ is defined for all real x , and state the corresponding range.
- b** Obtain an expression for $f[g(x)]$ in terms of x .
- c** Draw the graph of the composite function $f[g(x)]$.



12 Use the diagram on the right to solve each of the following equations:

- a** $|10 - 2x| = 4$
b $|x - 2| = 4$
c $|10 - 2x| = |x - 2|$

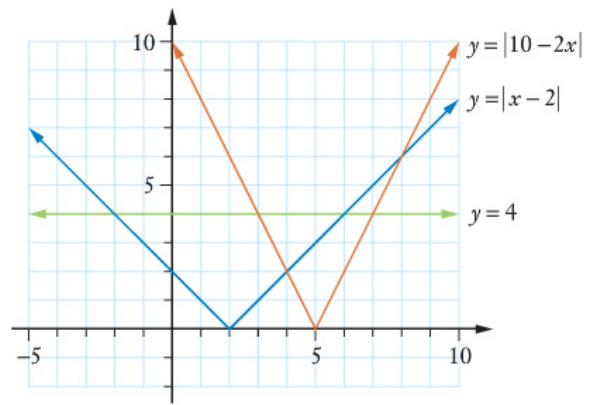

13 (Use an x -axis from -8 to 8 and a y -axis from -1 to 9 .)

Draw the graphs of $y = 5$, $y = |x|$,
 $y = 3 - 0.5x$ and $y = |2x + 3|$.

Hence solve the following equations.

- a** $|2x + 3| = 5$
b $3 - 0.5x = |x|$
c $3 - 0.5x = |2x + 3|$
d $|x| = |2x + 3|$

14 (Use an x -axis from -5 to 6 and a y -axis from -1 to 11 .)

For this question draw the graphs for parts **a**, **b** and **c** on the same set of axes.

- a** Draw the graph of $y = |x + 2|$.
b Draw the graph of $y = |x - 3|$.
c Hence draw the graph of $y = |x + 2| + |x - 3|$.
d Hence determine the values of x for which $|x + 2| + |x - 3| \leq 9$.

Use any appropriate method, other than simply using the solve facility of a calculator, to determine the values of x for which:

- 15** $|x + 6| = 1$ **16** $|x - 3| = -5$ **17** $|x - 10| = |x - 6|$
18 $|x + 5| = |2x - 14|$ **19** $|x - 3| = 2x$ **20** $|x + 5| + |x - 1| = 7$
21 $|x + 5| + |x - 3| = 8$ **22** $|x - 8| = |2 - x| - 6$ **23** $|x - 3| \geq |x + 5|$
24 $|2x - 5| \geq -5$ **25** $|x - 11| \geq |x + 5|$ **26** $|x + 4| > x + 2$

27 The diagram on the right shows all values of x for which

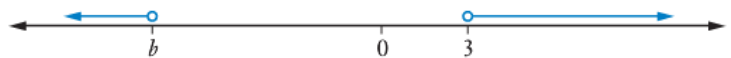

$$|2x + 5| * a$$

where '*' is one of $<$, \leq , $>$, or \geq , and a and b are constants.

Determine which of these symbols * represents and find the values of a and b .

- 28** The diagram on the right shows all values of x for which

$$|x - 3| * |x - a|$$

where '*' is one of $<$, \leq , $>$, or \geq , and a is a constant.

Determine which of these symbols * represents and find the value of a .

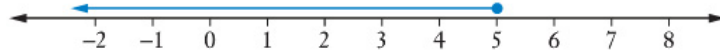

- 29** The diagram on the right shows all values of x for which

$$|2x + 5| * |x + a|$$

where '*' is one of $<$, \leq , $>$, or \geq , and a is a constant.

Determine which of these symbols * represents and find the value of a .

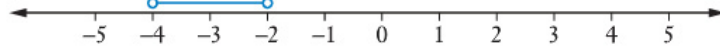

- 30** The graph below left shows the function $y = |0.5x - 1|$.

The graph below right shows the function $y = a|x - b| + c$, for constant a , b and c .

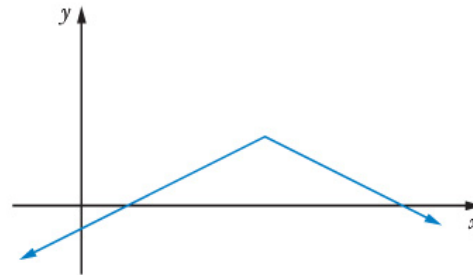
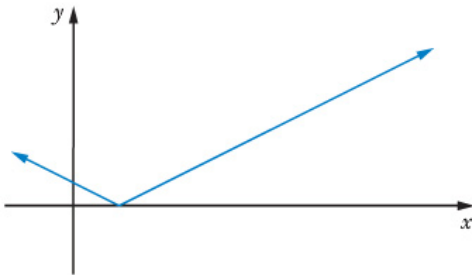

Given that the two graphs, if drawn on the same axes, would coincide for $2 \leq x \leq 8$, and nowhere else, determine a , b and c .

The graph of $y = \frac{1}{f(x)}$

The graph on the right shows the quadratic function

$$\begin{aligned} y &= x^2 - 2x - 3 \\ &= (x + 1)(x - 3). \end{aligned}$$

The points marked A and B are the x -axis intercepts, point C is the y -axis intercept and point D is the minimum point of the function.

- Write down the coordinates of the points A, B, C and D.
- Before turning to the next page, try to sketch the graph of

$$y = \frac{1}{(x + 1)(x - 3)}$$

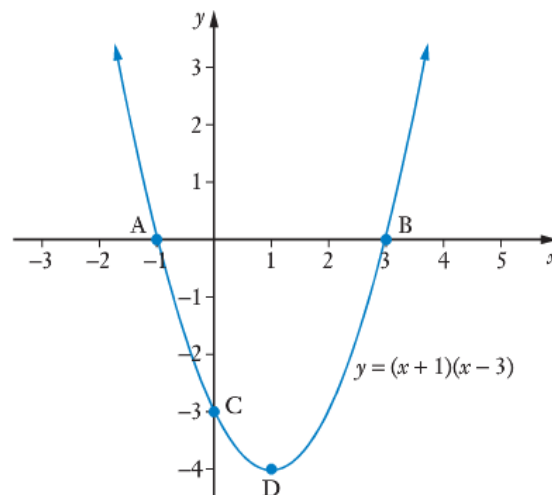

The equation and graph of $y = f(x)$ can tell us a lot about the graph of $y = \frac{1}{f(x)}$.

- Values of x for which $f(x) = 0$ will be values for which $\frac{1}{f(x)}$ will be undefined.
- Values of x for which $f(x)$ is positive (or negative) also give positive (or negative) values for $\frac{1}{f(x)}$.
- The x -coordinate of any local minimum (or local maximum) point on $y = f(x)$ will be the x -coordinate of a local maximum (or local minimum) point on $y = \frac{1}{f(x)}$.

How does your sketch of

$$y = \frac{1}{(x+1)(x-3)}$$

compare with the graph on the right?

With the quadratic $(x+1)(x-3)$
 equalling zero when $x = -1$
 and when $x = 3$
 it follows that

$$y = \frac{1}{(x+1)(x-3)}$$

will be undefined for $x = -1$
 and for $x = 3$,
 as shown in the graph.

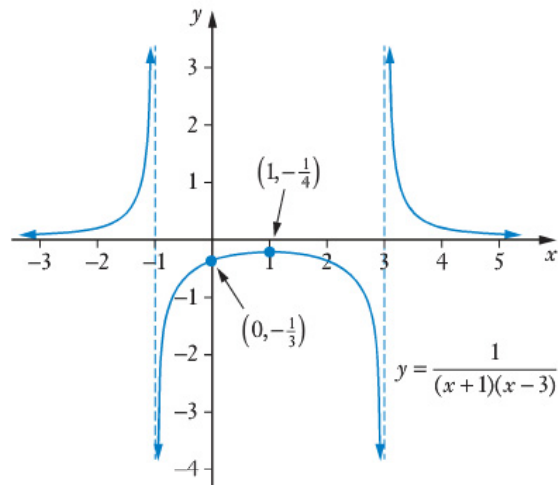

We say that $y = \frac{1}{(x+1)(x-3)}$ is **not continuous** at $x = -1$ and at $x = 3$.

Notice from the graph that as we travel along the curve approaching $x = -1$ from the left hand side the function heads off towards very large positive numbers.

We say that as x tends towards -1 from the left, y tends to positive infinity.

We write: As $x \rightarrow -1^-$ then $y \rightarrow +\infty$.

If instead we approach $x = -1$ from the right hand side, the function heads off towards very large negative numbers.

I.e. As $x \rightarrow -1^+$ then $y \rightarrow -\infty$.

Similarly As $x \rightarrow 3^-$ then $y \rightarrow -\infty$
 and as $x \rightarrow 3^+$ then $y \rightarrow +\infty$.

With access to a graphic calculator we can very quickly display the graph of a function. However there are often features of the graph that should be obvious to us as soon as we see the equation of the function.

For example, we should not need to view the graph of $y = \frac{1}{x-1}$ to realise that:

- The function is undefined for $x = 1$. ($x = 1$ will be a vertical asymptote.)

Indeed, as x approaches 1 from ‘the greater than 1 side’
(imagine substituting $x = 1.01, x = 1.001, x = 1.0001$ etc) then $y \rightarrow +\infty$.

As $x \rightarrow 1^+$ then $y \rightarrow +\infty$.

and, as x approaches 1 from ‘the less than 1 side’
(imagine substituting $x = 0.99, x = 0.999, x = 0.9999$ etc) then $y \rightarrow -\infty$.

As $x \rightarrow 1^-$ then $y \rightarrow -\infty$.

- There is no x value that gives $y = 0$ but, as $x \rightarrow +\infty$ then $y \rightarrow 0^+$
and as $x \rightarrow -\infty$ then $y \rightarrow 0^-$

These facts can be confirmed on the graph of

$$y = \frac{1}{x-1}$$

shown on the right.

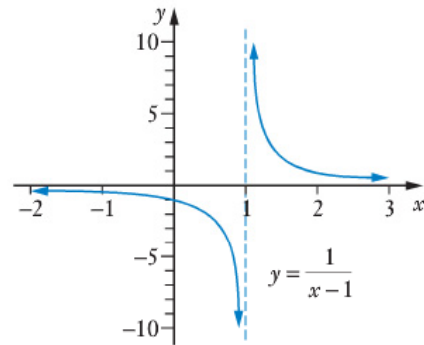

The graph of $y = \frac{f(x)}{g(x)}$ for $f(x)$ and $g(x)$ polynomials

The examples that follow involve sketching graphs of rational functions where both numerator and denominator are polynomials. Such functions are usually sketched by first considering some or all of

- intercepts with the axes,
- behaviour as $x \rightarrow \pm\infty$,
- vertical asymptotes,
- turning points,

and any other relevant information apparent from the equation, for example symmetry.

Also, if the order of $f(x) \geq$ the order of $g(x)$, i.e. if the algebraic fraction is improper, we may also consider rearranging the expression to ‘break down’ the improper fraction.



- Note • The behaviour of $\frac{f(x)}{g(x)}$ as $x \rightarrow \pm\infty$ can be determined by considering the ‘dominant powers’ of $f(x)$ and $g(x)$.

$$\text{For example, consider } y = \frac{3x^2 + 2x - 5}{2x^2 - x + 6}. \quad \text{As } x \rightarrow \pm\infty, \quad y \rightarrow \frac{3x^2}{2x^2} = \frac{3}{2}. \quad (x \neq 0)$$

The reader should check the correctness of this by viewing the graph of the function on a calculator.

- Using calculus to determine any turning points on the graph of $y = \frac{f(x)}{g(x)}$ will generally require use of the quotient rule for differentiation. It is assumed that you will have recently encountered this rule in your concurrent study of Unit Three of *Mathematics Methods*.

EXAMPLE 18

Make a sketch of the function with equation $y = \frac{x-4}{x-2}$.

Solution

The given fraction is improper so we could consider breaking it down:

$$\begin{aligned} y &= \frac{x-4}{x-2} = \frac{x-2-2}{x-2} \\ &= 1 - \frac{2}{x-2} \end{aligned}$$

If $x = 4$, $y = 0$. Cuts x -axis at $(4, 0)$.

If $x = 0$, $y = 2$. Cuts y -axis at $(0, 2)$.

As $x \rightarrow \pm\infty$, $y \rightarrow \frac{x}{x}$, i.e. 1.

$$\left[\begin{array}{l} \text{Indeed, from } y = 1 - \frac{2}{x-2}, \text{ as } x \rightarrow +\infty, y \rightarrow 1^-, \\ \text{and, as } x \rightarrow -\infty, y \rightarrow 1^+. \end{array} \right]$$

If $x = 2$, y is undefined. $x = 2$ is a vertical asymptote.

$$\left[\begin{array}{l} \text{Indeed, as } x \rightarrow 2^+, y \rightarrow -\infty, \\ \text{and as } x \rightarrow 2^-, y \rightarrow +\infty. \end{array} \right]$$

$$\begin{aligned} \text{If } y = \frac{x-4}{x-2}, \text{ using the quotient rule } \frac{dy}{dx} &= \frac{(x-2)(1) - (x-4)(1)}{(x-2)^2} \\ &= \frac{2}{(x-2)^2} \neq 0 \end{aligned}$$

There are no stationary points (and the gradient is always positive).

With this information (and even without the information bracketed above) a sketch can be completed. See the next page.

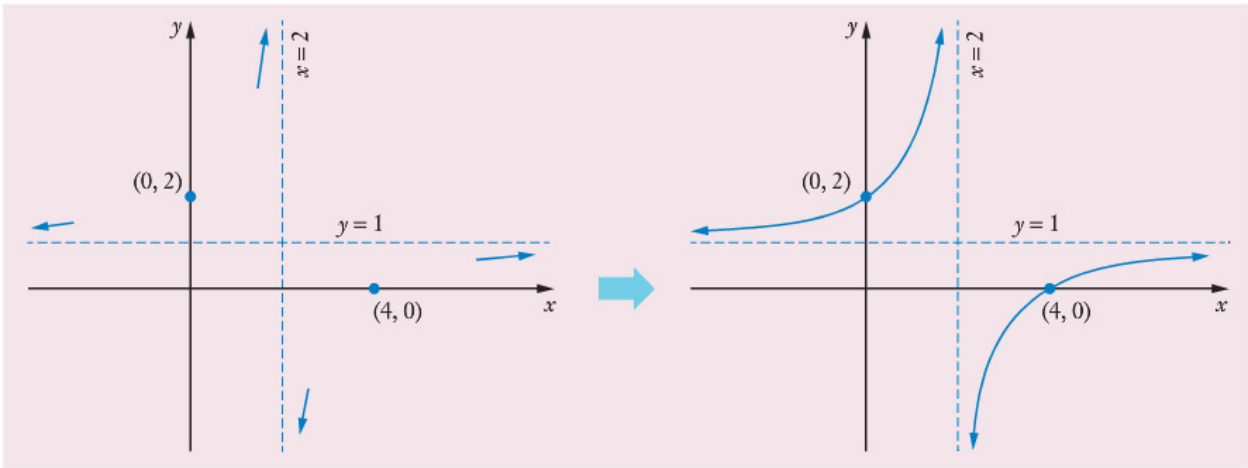

EXAMPLE 19

Make a sketch of the function with equation $y = \frac{2x-1}{x(x+4)}$.

Solution

If $x = 0.5$, $y = 0$. Cuts x -axis at $(0.5, 0)$.

If $x = 0$, y is undefined. $x = 0$ is a vertical asymptote.

Indeed, as $x \rightarrow 0^+$, (consider, for example, $x = 0.01$) $y \rightarrow -\infty$,
and as $x \rightarrow 0^-$, (consider, for example, $x = -0.01$) $y \rightarrow +\infty$.

If $x = -4$, y is undefined. $x = -4$ is a vertical asymptote.

Indeed, as $x \rightarrow -4^+$, (consider, for example, $x = -3.9$) $y \rightarrow +\infty$,
and as $x \rightarrow -4^-$, (consider, for example, $x = -4.1$) $y \rightarrow -\infty$.

As $x \rightarrow \pm\infty$, $y \rightarrow \frac{2x}{x^2}$, i.e. $\frac{2}{x}$. As $x \rightarrow +\infty$, $y \rightarrow 0^+$. As $x \rightarrow -\infty$, $y \rightarrow 0^-$.

If $y = \frac{2x-1}{x(x+4)}$, using the quotient rule, and simplifying, gives $\frac{dy}{dx} = \frac{-2(x-2)(x+1)}{x^2(x+4)}$

There are stationary points when $x = -1$ and when $x = 2$.

When $x = -1$, $y = 1$. When $x = 2$, $y = 0.25$. Stationary points exist at $(-1, 1)$ and $(2, 0.25)$.

The nature of each of these can be determined by considering the gradients either side of $x = -1$ and $x = 2$, or the sketch can be completed using the facts already determined.

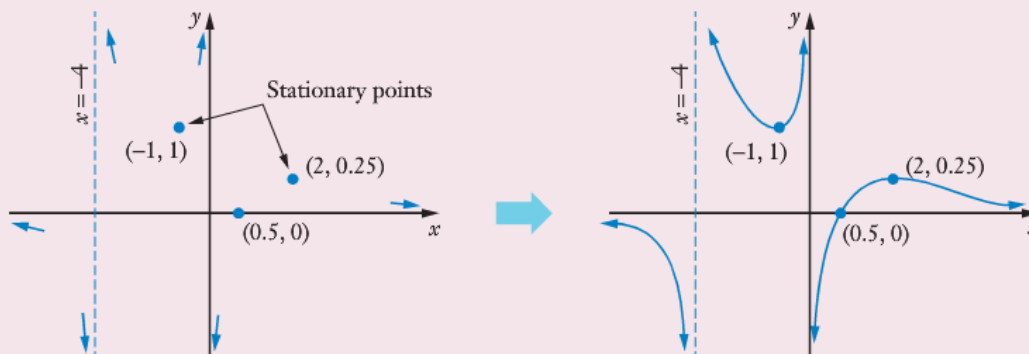

Note: From the shape of the graph there must also be a point of inflection (not horizontal) to the right of the local maximum.

EXAMPLE 20

Sketch the graph of the function $y = \frac{x^2 - 4}{x - 1}$.

Solution

Note that $y = \frac{x^2 - 4}{x - 1}$ and $y = \frac{x^2 - 4}{x - 1}$

$$= \frac{(x+2)(x-2)}{x-1} = \frac{x(x-1) + x - 4}{x-1}$$

$$= \frac{x(x-1)}{x-1} + \frac{(x-1) - 3}{x-1}$$

$$= x + 1 - \frac{3}{x-1}$$

If $x = 2$, $y = 0$. Cuts x -axis at $(2, 0)$.

If $x = -2$, $y = 0$. Cuts x -axis at $(-2, 0)$.

If $x = 0$, $y = 4$. Cuts y -axis at $(0, 4)$.

As $x \rightarrow \pm\infty$, $y \rightarrow x + 1$. The line $y = x + 1$ will be an **oblique asymptote**.

As $x \rightarrow +\infty$, $y \rightarrow (x + 1)^-$. As $x \rightarrow -\infty$, $y \rightarrow (x + 1)^+$.

If $x = 1$, y is undefined. $x = 1$ is a vertical asymptote.

As $x \rightarrow 1^+$, $y \rightarrow -\infty$. As $x \rightarrow 1^-$, $y \rightarrow +\infty$.

If $y = \frac{x^2 - 4}{x - 1}$, using the quotient rule $\frac{dy}{dx} = \frac{(x-1)(2x) - (x^2 - 4)(1)}{(x-1)^2}$

$$= \frac{x^2 - 2x + 4}{(x-1)^2}$$

$$x^2 - 2x + 4 = 0 \text{ has no real solutions.}$$

Hence no stationary points.

Placing this information on a graph, below left, the sketch can be completed, below right.

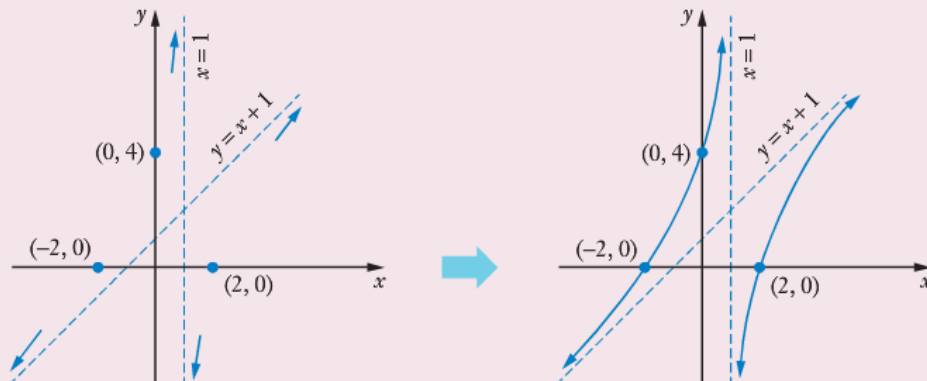

EXAMPLE 21

Sketch the graph of the function $y = \frac{x+3}{x+3}$.

Solution

The immediate reaction may be to simply 'cancel the $(x+3)$'s', to give $y = 1$.

However, if we do this, we must remember that the initial function is undefined for $x = -3$.

$$\begin{aligned}\text{Thus } y &= \frac{x+3}{x+3} \\ &= 1, \quad x \neq -3\end{aligned}$$

The function is sketched on the right.

The open circle shows a point of discontinuity.

The function is not defined for $x = -3$.

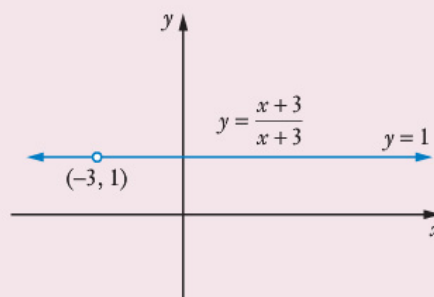

EXAMPLE 22

Sketch the graph of the function $y = \frac{x^2 - 4}{x(x-2)}$.

Solution

$$\begin{aligned}\text{Note that } y &= \frac{x^2 - 4}{x(x-2)} \\ &= \frac{(x-2)(x+2)}{x(x-2)} \\ &= \frac{(x+2)}{x} \quad x \neq 2. \\ &= 1 + \frac{2}{x} \quad x \neq 2.\end{aligned}$$

The graph will be that of $y = \frac{1}{x}$ dilated $\uparrow \times 2$, translated 1 unit \uparrow , with $x \neq 2$.

Also note that if $x = -2$, $y = 0$.

Cuts x -axis at $(-2, 0)$.

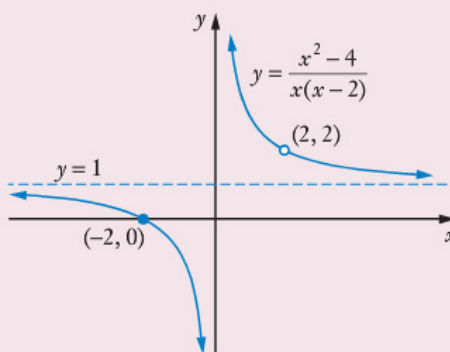

EXAMPLE 23

Make a sketch of the function $y = \frac{x^2 + 2x + 1}{x - 2}$.

Solution

Note that $y = \frac{x^2 + 2x + 1}{x - 2}$ and $y = \frac{x^2 + 2x + 1}{x - 2}$

$$= \frac{(x+1)^2}{x-2} = \frac{x(x-2) + 4(x-2) + 9}{x-2}$$

$$= x + 4 + \frac{9}{x-2}$$

- If $x = -1$, $y = 0$. Cuts (or perhaps *touches*) x -axis at $(-1, 0)$.
 If $x = 0$, $y = -0.5$. Cuts y -axis at $(0, -0.5)$.
 As $x \rightarrow \pm\infty$, $y \rightarrow x + 4$. The line $y = x + 4$ will be an **oblique asymptote**.
 As $x \rightarrow +\infty$, $y \rightarrow (x + 4)^+$. As $x \rightarrow -\infty$, $y \rightarrow (x + 4)^-$.
 If $x = 2$, y is undefined. $x = 2$ is a vertical asymptote.
 As $x \rightarrow 2^+$, $y \rightarrow +\infty$. As $x \rightarrow 2^-$, $y \rightarrow -\infty$.
 If $y = \frac{x^2 + 2x + 1}{x - 2}$, using the quotient rule $\frac{dy}{dx} = \frac{(x-2)(2x+2) - (x^2+2x+1)(1)}{(x-2)^2}$
- $$= \frac{x^2 - 4x - 5}{(x-2)^2}$$
- $$= \frac{(x-5)(x+1)}{(x-2)^2}$$

There are stationary points at $(-1, 0)$ and at $(5, 12)$. Their nature can be determined as shown below (or the sketch can be completed from the facts already determined).

	Gradient either side of $x = -1$			Gradient either side of $x = 5$		
	$x = -1.1$	$x = -1$	$x = -0.9$	$x = 4.9$	$x = 5$	$x = 5.1$
$x - 5$	-ve	-ve	-ve	-ve	zero	+ve
$x + 1$	-ve	zero	+ve	+ve	+ve	+ve
$\frac{(x-5)(x+1)}{(x-2)^2}$	+ve	zero	-ve	-ve	zero	+ve
	/	—	\	\	—	/

Local maximum point at $(-1, 0)$ and a local minimum point at $(5, 12)$.

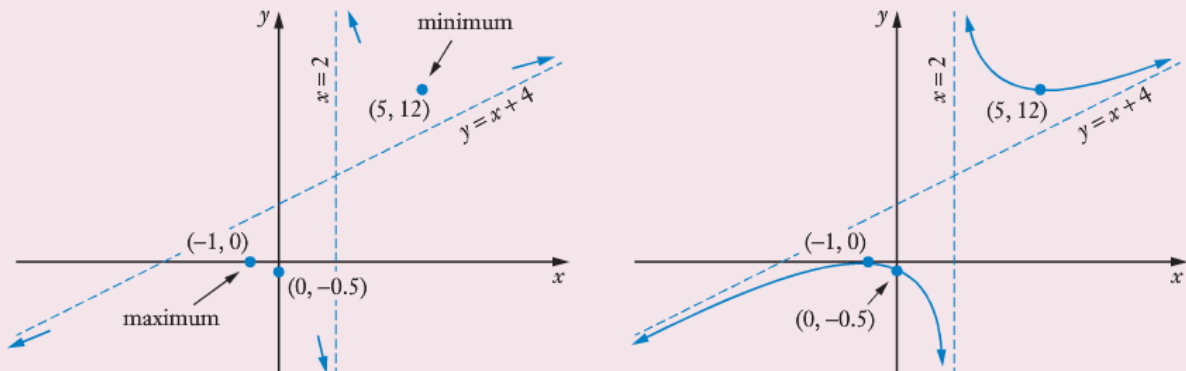

Exercise 3D

For what values of x will the following functions have vertical asymptotes?

1 $y = \frac{2}{x}$

2 $y = \frac{5}{x-1}$

3 $y = \frac{5}{(x-3)(2x-1)}$

4 $y = \frac{x+3}{x-3}$

What values of y cannot be obtained from each of the following functions if x can take all real values for which the function is defined?

5 $y = \frac{3}{x}$

6 $y = 2 + \frac{3}{x}$

7 $y = \frac{1}{x+1}$

8 $y = \frac{x-1}{x+1}$

For each of the following, complete statements of the form:

As $x \rightarrow +\infty$ then $y \rightarrow$????

and as $x \rightarrow -\infty$ then $y \rightarrow$????

9 $y = \frac{1}{x-5}$

10 $y = \frac{x+2}{x-2}$

11 $y = \frac{5x^2 + 7x - 3}{x^2 + 6}$

12 $y = \frac{3x(x+2)}{x^2+1}$

13 For $y = \frac{1}{x-3}$ copy and complete:

As $x \rightarrow 3^+$ then $y \rightarrow$????

and

as $x \rightarrow 3^-$ then $y \rightarrow$????

14 For $y = \frac{1}{1-x}$ copy and complete:

As $x \rightarrow 1^+$ then $y \rightarrow$????

and

as $x \rightarrow 1^-$ then $y \rightarrow$????

15 For $y = \frac{x^5+1}{x^2}$ copy and complete:

As $x \rightarrow 0^+$ then $y \rightarrow$????

and

as $x \rightarrow 0^-$ then $y \rightarrow$????

16 Given that the equations of each of the following sketch graphs are in the equations box below, select the appropriate equation.

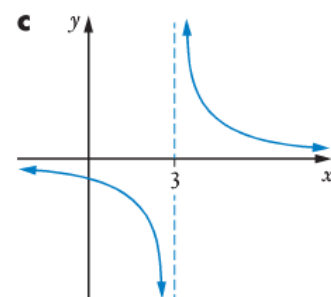
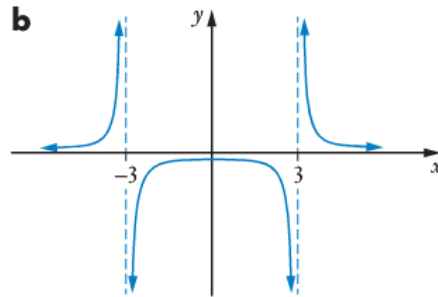
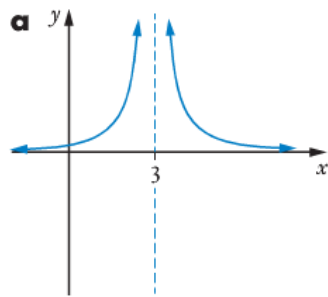

Equations Box

$$y = \frac{1}{(3+x)^2}$$

$$y = \frac{1}{(x+3)(x-3)}$$

$$y = \frac{1}{(3-x)}$$

$$y = \frac{1}{(3+x)(3-x)}$$

$$y = \frac{1}{(x-3)^2}$$

$$y = \frac{1}{(x-3)}$$

- 17** Sketch both $y = (x + 2)(x - 2)$ and $y = \frac{1}{(x + 2)(x - 2)}$ on the same set of axes.

Once completed, check the correctness of your sketch by viewing the graphs of the functions on a graphic calculator.

- 18** The graph of $y = f(x)$ is shown on the right.

Produce a sketch of $y = \frac{1}{f(x)}$.

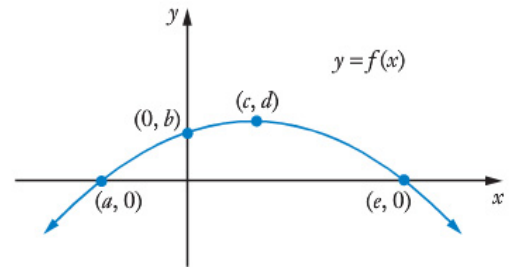

- 19** The graph of $y = g(x)$ is shown on the right.

Produce a sketch of $y = \frac{1}{g(x)}$.

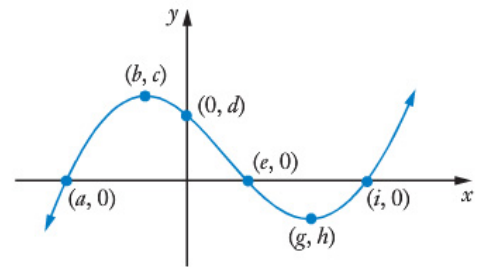

Without the assistance of a graphic calculator, make sketches of the graphs of the following functions.

20 $y = \frac{x + 3}{x - 1}$

21 $y = \frac{2x - 4}{x + 2}$

22 $y = \frac{2(x - 4)}{x - 4}$

23 $y = \frac{x^2 - 9}{x(x + 3)}$

24 $y = \frac{36(2 - x)}{x(x + 6)}$

25 $y = \frac{1 - x}{x(x + 3)}$

26 $y = \frac{x}{x^2 - 1}$

27 $y = \frac{(x - 4)(x - 1)}{x - 2}$

28 $y = \frac{x^2 + 3x}{x - 1}$

29 $y = \frac{x^2 - 3x - 4}{x^3 - 2x^2 - 3x}$

30 $y = \frac{3}{x^3 - 3x^2 + 3x}$

31 $y = \frac{x^3}{x - 2}$

Absolute value – extension activity

How would you construct the graph of $|x| + |y| = 8$?

One approach is to consider each of the four quadrants in turn:

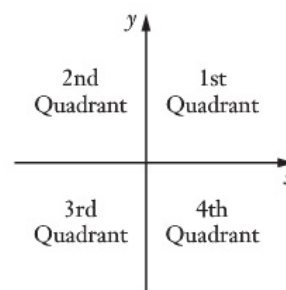

In the first quadrant $x > 0$ and $y > 0$ so we draw $x + y = 8$ in this quadrant:

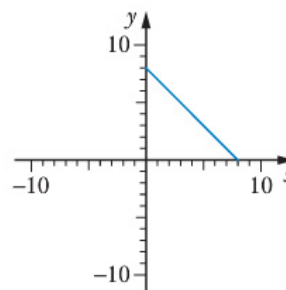

In the second quadrant $x < 0$ and $y > 0$ so we draw $-x + y = 8$ in this quadrant:

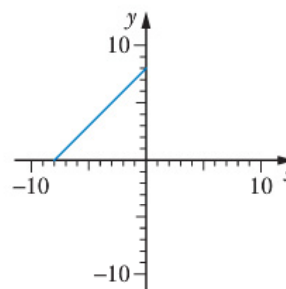

Continuing in this way we would draw $-x - y = 8$ in the third quadrant and $x - y = 8$ in the fourth quadrant, to give the graph of $|x| + |y| = 8$.

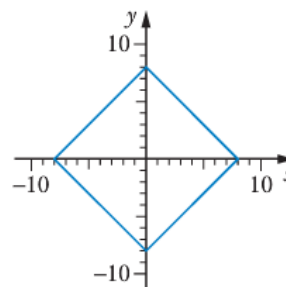

Alternatively we could consider $|x| + |y| = 8$ as $y = \begin{cases} 8 - |x| & \text{for } y \geq 0 \\ 8 + |x| & \text{for } y < 0 \end{cases}$.

Produce graphs of each of the following:

- $|x| - |y| = 8$
- $3|x| - 2|y| = 24$
- $|x|^2 + |y| = 4|x|$
- $|y| = |x|^2 + 2|x| - 8$
- $2|x| + |y| = 10$
- $|y| = 4 - |x|^2$
- $|x|^2 + |y| = 4x$
- $|y| = |x|^2 + 2x - 8$



Rational functions – extension activity

The graph of $f(x) = \frac{3x-2}{x(x+2)}$ is shown on the right.

Notice that there seems to be a horizontal band, shown shaded in the diagram, in which the function does not appear.

Using calculus, or a graphic calculator, to determine the coordinates of the turning points we can say that the range of $f(x)$ includes $y \leq 0.5$ and also $y \geq 4.5$, but excludes $0.5 < y < 4.5$.

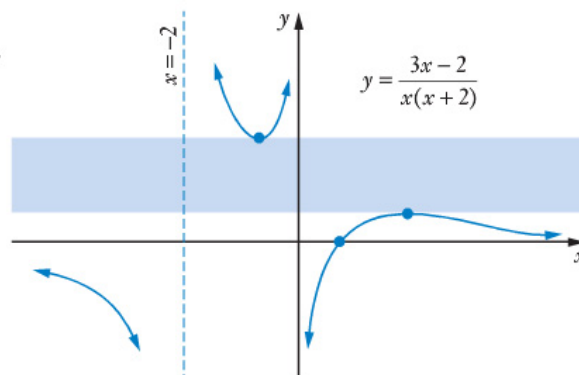

An alternative approach for determining this range of values y can take uses a quadratic equation approach and is shown below.

$$\text{Let } y = \frac{3x-2}{x(x+2)}$$

Then for $x \neq 0$ and $x \neq -2$

$$\begin{aligned}yx(x+2) &= 3x-2 \\yx^2 + 2yx &= 3x-2 \\yx^2 + (2y-3)x + 2 &= 0\end{aligned}\quad [1]$$

If $y = 0$ equation [1] reduces to $-3x + 2 = 0$, giving $x = \frac{2}{3}$, the x -axis intercept.

If $y \neq 0$ equation [1] is a quadratic equation.

$ax^2 + bx + c$ has real solutions if

Thus from [1], for real x ,

$$\begin{aligned}b^2 - 4ac &\geq 0 \\(2y-3)^2 - 4(y)(2) &\geq 0 \\4y^2 - 20y + 9 &\geq 0 \\(2y-9)(2y-1) &\geq 0\end{aligned}$$

	$y < 0.5$	$0.5 < y < 4.5$	$y > 4.5$
$2y - 9$	-ve	-ve	+ve
$2y - 1$	-ve	+ve	+ve
$(2y - 9)(2y - 1)$	+ve	-ve	+ve

Thus for real x we must have $y \leq 0.5$ or $y \geq 4.5$ which agrees with the values mentioned earlier, found using calculus or a graphic calculator.

Before the availability of graphic calculators, the above method was used to give useful information about the range of a function. Whilst it is not suggested we would use it very often now when we can view the graph on a calculator so easily, do attempt the following by the above method and then check that your answers agree with the display from a graphic calculator.

1 $y = \frac{9(2x-1)}{x(x+12)}$

2 $y = \frac{2x+2}{x^2+x+1}$

3 $y = \frac{8x+7}{2(x+1)(x+2)}$

4 $y = \frac{x-4}{(x-3)(x-5)}$

5 $y = \frac{3x-10}{(x-2)(x-3)}$

6 $y = \frac{3x+2}{(7x^2+5x+1)}$

Miscellaneous exercise three

This miscellaneous exercise may include questions involving the work of this chapter, the work of any previous chapters, and the ideas mentioned in the Preliminary work section at the beginning of the book.

- 1 Without the assistance of your calculator find all values of x , real and complex, for which:

$$x^3 + 7x^2 + 19x + 13 = 0$$

- 2 The graph on the right shows the function

$$y = \frac{1}{(x-1)(x+3)}$$

- a State the values of a and b .
 b By considering the coordinates of the turning point of

$$y = (x-1)(x+3)$$

find the coordinates of point C, the local maximum point.

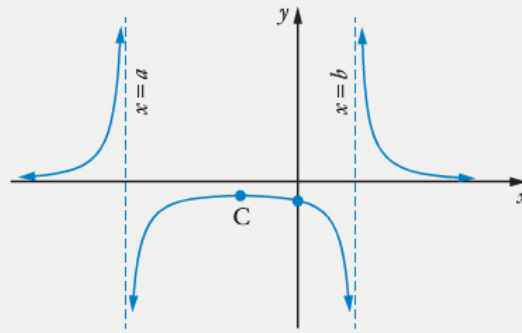

- 3 The graph on the right shows some function $y = f(x)$.

Produce sketches of the graphs of each of the following:

- a $y = -f(x)$ b $y = f(-x)$
 c $y = |f(x)|$ d $y = f(|x|)$

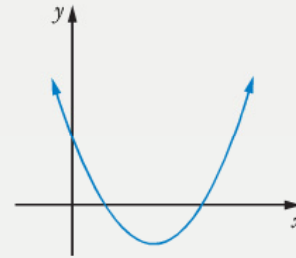

- 4 Sketch the graph of

- a $y = |x - a|$, $a > 0$,
 b $y = |2x - a|$, $a > 0$.

Hence determine the values of x for which $|2x - a| \leq |x - a|$.

- 5 The graph on the right shows the function

$$f(x) = (x-2)^2 - 1$$

for a restricted domain.

- a State the domain and range of $f(x)$ shown in the diagram.

With the domain of $f(x)$ as shown in the graph:

- b state the domain and range of $f^{-1}(x)$,
 c show $f(x)$ and $f^{-1}(x)$ on a single sketch,
 d find an algebraic expression for $f^{-1}(x)$.

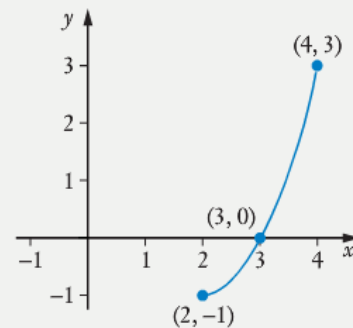

6 Find the values of the scalars p and q in each of the following cases given that \mathbf{a} and \mathbf{b} are non-parallel, non-zero vectors.

a $p\mathbf{a} = q\mathbf{b}$

b $(p - 3)\mathbf{a} = q\mathbf{b}$

c $(p + 2)\mathbf{a} = (q - 1)\mathbf{b}$

d $p\mathbf{a} + 2\mathbf{b} = 3\mathbf{a} - q\mathbf{b}$

e $p\mathbf{a} + q\mathbf{a} + p\mathbf{b} - 2q\mathbf{b} = 3\mathbf{a} + 6\mathbf{b}$

f $p\mathbf{a} + 2\mathbf{a} - 2p\mathbf{b} = \mathbf{b} + 5q\mathbf{b} - q\mathbf{a}$

7 If $\mathbf{a} = 2\mathbf{i} + 4\mathbf{j}$ and $\mathbf{b} = 5\mathbf{i} - 3\mathbf{j}$ express each of the following in the form $p\mathbf{a} + q\mathbf{b}$, where p and q are suitably chosen scalars.

a $-9\mathbf{i} + 21\mathbf{j}$

b $4\mathbf{i} - 18\mathbf{j}$

c $-7\mathbf{i} + 12\mathbf{j}$

d $-34\mathbf{i} + 23\mathbf{j}$

8 a Determine, in exact cartesian form, the complex number z for which:

$$\frac{1}{z} = \frac{-3 + 2\sqrt{3}i}{3 + 5\sqrt{3}i}$$

b Write the z of part **a** in exact polar form.

9 Simplify $\frac{1}{4 \operatorname{cis}\left(-\frac{\pi}{6}\right)}$ giving an exact answer in the form $a + ib$.

10 The four complex numbers z, p, q and w shown on the Argand diagram on the right all have the same magnitude and p is perpendicular to z , q is perpendicular to p , and w is perpendicular to q .

Express p, q and w in terms of z .

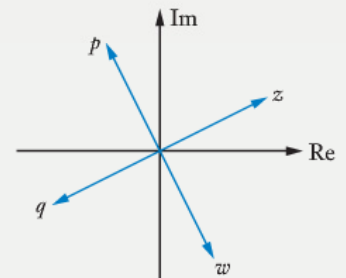

11 If $z = 2 \operatorname{cis}\left(\frac{\pi}{4}\right)$ and $w = 1 \operatorname{cis}\left(\frac{\pi}{6}\right)$ express each of the following in the form $r \operatorname{cis} \theta$ with $r \geq 0$ and $-\pi < \theta \leq \pi$.

a zw

b $\frac{z}{w}$

c w^2

d z^3

e w^9

f z^9

12 Express $(-\sqrt{3} + i)$ in the form $r \operatorname{cis} \theta$ with $r \geq 0$ and $-\pi < \theta \leq \pi$.
Hence use de Moivre's theorem to simplify $(-\sqrt{3} + i)^{12}$.

4.

Vector equation of a line in the x - y plane

- Interception/collision
- Vector equation of a straight line in the x - y plane
- Point of intersection of two straight lines
- Scalar product form of the equation of a straight line in the x - y plane
- Vector equations of curves in the x - y plane
- Vector equations of circles in the x - y plane
- Closest approach
- Distance from a point to a line
- Miscellaneous exercise four

Note

In this chapter we are considering two-dimensional vectors and lines, hence the mention of 'in the x - y plane' in the chapter title. The next chapter will consider similar concepts in three-dimensional space.

Situation



Shutterstock.com/lenlon

Two ships, A and B, have the following position vectors, \mathbf{r} , and velocity vectors, \mathbf{v} , at 7 a.m. one morning.

$$\mathbf{r}_A = (186\mathbf{i} + 44\mathbf{j}) \text{ km.}$$

$$\mathbf{v}_A = (8\mathbf{i} + 12\mathbf{j}) \text{ km/h.}$$

$$\mathbf{r}_B = (228\mathbf{i} + 58\mathbf{j}) \text{ km.}$$

$$\mathbf{v}_B = (-16\mathbf{i} + 4\mathbf{j}) \text{ km/h.}$$

At the same time a third vessel, C, has position and velocity vectors as follows.

$$\mathbf{r}_C = (215\mathbf{i} + 101\mathbf{j}) \text{ km.}$$

$$\mathbf{v}_C = (-12\mathbf{i} - 16\mathbf{j}) \text{ km/h.}$$

Prove that if A and B continue with their stated velocities they will collide and find the time of collision and the position vector of its location.

At the moment of impact between A and B, vessel C, responding to a distress call, immediately changes direction and heads to the scene of the collision at one-and-a-half times its previous speed. How many minutes after the collision occurred does vessel C arrive on the scene?

Interception/collision

Suppose that an object is at a point A, position vector \mathbf{a} , and is moving along the path shown dashed in the diagram, with velocity \mathbf{v} .

After a further t units of time the object will be at a point R, position vector \mathbf{r} , where

$$\mathbf{r} = \mathbf{a} + t\mathbf{v} \quad [1]$$

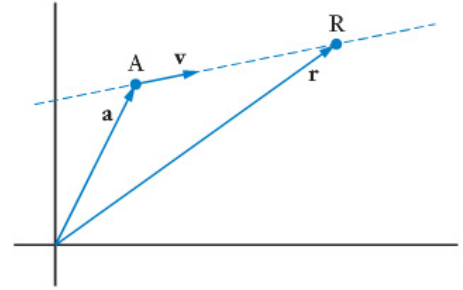

\mathbf{r} , the position vector of the object at time t , is a function of time. Substituting a particular value of t into equation [1] will give the position vector of the object at that time. Being a function of time we could write the position vector as $\mathbf{r}(t)$.

Did you use this idea to solve the situation on the previous page? Example 1 is similar to that situation and the method of solution uses the above idea. (This approach is not the only way of solving the situation and you may well have used a different method.)

EXAMPLE 1

At noon, boats P and Q have position vectors (\mathbf{r}) and velocity vectors (\mathbf{v}) as follows:

$$\mathbf{r}_P = -85\mathbf{i} \text{ km.}$$

$$\mathbf{v}_P = (6\mathbf{i} + 8\mathbf{j}) \text{ km/h.}$$

$$\mathbf{r}_Q = (-95\mathbf{i} + 40\mathbf{j}) \text{ km.}$$

$$\mathbf{v}_Q = (10\mathbf{i} - 8\mathbf{j}) \text{ km/h.}$$

- Prove that if P and Q continue with these velocities they will collide and find the time of collision and the position vector of its location.
- How far from the scene of the collision is the nearest coastal heliport, position vector $-56\mathbf{i} + 68\mathbf{j}$, the helicopter base from which help will arrive?

Solution

- Position vector of P, t hours past noon:

$$\begin{aligned} \mathbf{r}_P(t) &= -85\mathbf{i} + t(6\mathbf{i} + 8\mathbf{j}) \\ &= (6t - 85)\mathbf{i} + 8t\mathbf{j} \end{aligned}$$

- Position vector of Q, t hours past noon:

$$\begin{aligned} \mathbf{r}_Q(t) &= -95\mathbf{i} + 40\mathbf{j} + t(10\mathbf{i} - 8\mathbf{j}) \\ &= (10t - 95)\mathbf{i} + (40 - 8t)\mathbf{j} \end{aligned}$$

The ships will collide if, for some value of t , $\mathbf{r}_P(t) = \mathbf{r}_Q(t)$

$$\text{i.e.} \quad (6t - 85)\mathbf{i} + 8t\mathbf{j} = (10t - 95)\mathbf{i} + (40 - 8t)\mathbf{j}$$

Equating the \mathbf{i} components

$$6t - 85 = 10t - 95$$

$$t = 2.5$$

Equating the \mathbf{j} components

$$8t = 40 - 8t$$

$$t = 2.5$$

Thus when $t = 2.5$ the position vectors of P and Q have the same \mathbf{i} components *and* the same \mathbf{j} components. i.e. P and Q are in the same place at 2.30 p.m.

$$\begin{aligned} \text{At this time } \mathbf{r}_P &= \mathbf{r}_Q \\ &= -70\mathbf{i} + 20\mathbf{j} \end{aligned}$$

P and Q will collide at 2.30 p.m. at position vector $(-70\mathbf{i} + 20\mathbf{j})$ km.

b The vector from the location of the collision, to the heliport will be \vec{CH} (see diagram).

$$\begin{aligned}\vec{CH} &= \vec{CO} + \vec{OH} \\ &= -(-70\mathbf{i} + 20\mathbf{j}) + (-56\mathbf{i} + 68\mathbf{j}) \\ &= 14\mathbf{i} + 48\mathbf{j} \\ \therefore |\vec{CH}| &= \sqrt{14^2 + 48^2} \text{ km} \\ &= 50 \text{ km.}\end{aligned}$$

The scene of the collision is 50 km from the coastal heliport.

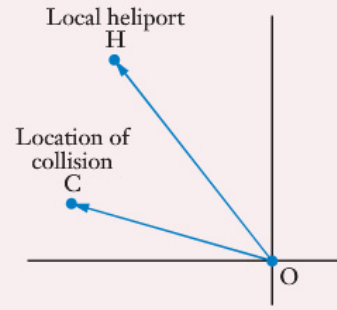

In the *Preliminary work* it was mentioned that the vector $a\mathbf{i} + b\mathbf{j}$ is sometimes written as the ordered pair $\langle a, b \rangle$ and sometimes as a column matrix $\begin{pmatrix} a \\ b \end{pmatrix}$.

The latter notation is used in the working of the next example.

EXAMPLE 2

The position vectors (\mathbf{r}) and velocity vectors (\mathbf{v}) of two ships A and B at certain times on a particular day were as follows:

At 9.00 a.m. $\mathbf{r}_A = (30\mathbf{i} + 50\mathbf{j}) \text{ km.}$ $\mathbf{v}_A = (12\mathbf{i} - 3\mathbf{j}) \text{ km/h.}$

At 9.30 a.m. $\mathbf{r}_B = (48\mathbf{i} + 30\mathbf{j}) \text{ km.}$ $\mathbf{v}_B = (8\mathbf{i} + 2\mathbf{j}) \text{ km/h.}$

Show that if the two ships continue with these velocity vectors they will not collide.

Solution

$$\begin{aligned}\text{At } t \text{ hours past 9 a.m. } \mathbf{r}_A(t) &= \begin{pmatrix} 30 \\ 50 \end{pmatrix} + t \begin{pmatrix} 12 \\ -3 \end{pmatrix} \\ &= \begin{pmatrix} 30 + 12t \\ 50 - 3t \end{pmatrix}\end{aligned}$$

$$\begin{aligned}\mathbf{r}_B(t) &= \begin{pmatrix} 48 \\ 30 \end{pmatrix} + (t - 0.5) \begin{pmatrix} 8 \\ 2 \end{pmatrix} \quad (t \geq 0.5) \\ &= \begin{pmatrix} 44 + 8t \\ 29 + 2t \end{pmatrix}\end{aligned}$$

Position vectors of A and B will have same \mathbf{i} component when $30 + 12t = 44 + 8t$
i.e. when $t = 3.5$

Position vectors of A and B will have same \mathbf{j} component when $50 - 3t = 29 + 2t$
i.e. when $t = 4.2$

The same \mathbf{i} component of position vector occurs at 12.30 p.m. but the same \mathbf{j} component occurs at 1.12 p.m. Thus A and B do not collide.



Exercise 4A

- 1 At the times stated, the position vectors (\mathbf{r}) and velocity vectors (\mathbf{v}) of bodies A, B, C, D, E and F are as follows:

$\mathbf{r}_A = (5\mathbf{i} + 4\mathbf{j}) \text{ km}$	$\mathbf{v}_A = (10\mathbf{i} - \mathbf{j}) \text{ km/h}$	at	8 a.m.
$\mathbf{r}_B = (6\mathbf{i} - 8\mathbf{j}) \text{ km}$	$\mathbf{v}_B = (2\mathbf{i} + 8\mathbf{j}) \text{ km/h}$	at	8 a.m.
$\mathbf{r}_C = (2\mathbf{i} + 3\mathbf{j}) \text{ km}$	$\mathbf{v}_C = (-4\mathbf{i} + 3\mathbf{j}) \text{ km/h}$	at	8 a.m.
$\mathbf{r}_D = (9\mathbf{i} - 10\mathbf{j}) \text{ km}$	$\mathbf{v}_D = (10\mathbf{i} + 6\mathbf{j}) \text{ km/h}$	at	7 a.m.
$\mathbf{r}_E = (16\mathbf{i} + 7\mathbf{j}) \text{ km}$	$\mathbf{v}_E = (-4\mathbf{i} + 3\mathbf{j}) \text{ km/h}$	at	9 a.m.
$\mathbf{r}_F = (2\mathbf{i} + 3\mathbf{j}) \text{ km}$	$\mathbf{v}_F = (12\mathbf{i} - 8\mathbf{j}) \text{ km/h}$	at	8.30 a.m.

In each case write, in the form $f(t)\mathbf{i} + g(t)\mathbf{j}$, an expression for the position vector of the body t hours after 8 a.m. (Assume each velocity continues unchanged.)

- 2 A ship has a position vector $(7\mathbf{i} + 10\mathbf{j}) \text{ km}$ at 5 a.m. and is moving with velocity vector $(3\mathbf{i} + 4\mathbf{j}) \text{ km/h}$. If the ship continues with this velocity what will be its position vector at
- a** 6 a.m.?
b 7 a.m.?
c 9 a.m.?
d What is the speed of the ship?
e At 8 a.m., how far is the ship from a lighthouse, position vector $(21\mathbf{i} + 20\mathbf{j}) \text{ km}$?

- 3 With respect to an origin O a boat has position vector $(9\mathbf{i} + 36\mathbf{j}) \text{ km}$ at 10 a.m. and is moving with velocity $(2\mathbf{i} + 12\mathbf{j}) \text{ km/h}$. Assuming that the boat had been travelling at that velocity for some hours what was its position vector at 9 a.m.?
How far was the boat from O at
- a** 9 a.m.?
b 8 a.m.?

- 4 At 3 p.m. one day two ships A and B have position vectors, \mathbf{r} km, and velocity vectors, \mathbf{v} km/h, as follows:

$\mathbf{r}_A = 21\mathbf{i} + 7\mathbf{j}$	$\mathbf{v}_A = 10\mathbf{i} + 5\mathbf{j}$
$\mathbf{r}_B = 25\mathbf{i} - 6\mathbf{j}$	$\mathbf{v}_B = 7\mathbf{i} + 10\mathbf{j}$

Assuming both ships maintain these velocities, how far apart will the ships be at

- a** 3 p.m.?
b 4 p.m.?
c 5 p.m.?
- 5 At 8 a.m. one morning two ships A and B have position vectors, \mathbf{r} km, and velocity vectors, \mathbf{v} km/h, as follows:

$\mathbf{r}_A = -5\mathbf{i} + 13\mathbf{j}$	$\mathbf{v}_A = 7\mathbf{i} - 2\mathbf{j}$
$\mathbf{r}_B = -3\mathbf{j}$	$\mathbf{v}_B = -3\mathbf{i} + 2\mathbf{j}$

Assuming both ships maintain these velocities, how far apart will the ships be at

- a** 9 a.m.?
b 10 a.m.?

- 6** At 8 a.m. one morning two ships A and B have position vectors, \mathbf{r} km, and velocity vectors, \mathbf{v} km/h, as follows:

$$\begin{aligned} \mathbf{r}_A &= 28\mathbf{i} - 5\mathbf{j} & \mathbf{v}_A &= -8\mathbf{i} + 4\mathbf{j} \\ \mathbf{r}_B &= 24\mathbf{j} & \mathbf{v}_B &= 6\mathbf{i} + 2\mathbf{j} \end{aligned}$$

- a** Obtain an expression in the form $f(t)\mathbf{i} + g(t)\mathbf{j}$ for the position vector of each ship t hours after 8 a.m.
b When will the ships be 25 km apart?

For each of the following determine whether the ships A and B will collide if they continue with the velocities given below. For those that do collide, find when this occurs and the position vector of the scene of the collision.

- 7** $\mathbf{r}_A = (12\mathbf{i} + 61\mathbf{j})$ km $\mathbf{v}_A = (7\mathbf{i} - 8\mathbf{j})$ km/h at 8.00 a.m.
 $\mathbf{r}_B = (57\mathbf{i} - 29\mathbf{j})$ km $\mathbf{v}_B = (-2\mathbf{i} + 10\mathbf{j})$ km/h at 8.00 a.m.
- 8** $\mathbf{r}_A = (-11\mathbf{i} - 8\mathbf{j})$ km $\mathbf{v}_A = (7\mathbf{i} - \mathbf{j})$ km/h at 8.00 a.m.
 $\mathbf{r}_B = (-2\mathbf{i} - 4\mathbf{j})$ km $\mathbf{v}_B = (4\mathbf{i} + 5\mathbf{j})$ km/h at 8.00 a.m.
- 9** $\mathbf{r}_A = (24\mathbf{i} - 25\mathbf{j})$ km $\mathbf{v}_A = (-3\mathbf{i} + 4\mathbf{j})$ km/h at 8.00 a.m.
 $\mathbf{r}_B = (-9\mathbf{i} + 33\mathbf{j})$ km $\mathbf{v}_B = (2\mathbf{i} - 5\mathbf{j})$ km/h at 9.00 a.m.
- 10** $\mathbf{r}_A = (-6\mathbf{i} + 44\mathbf{j})$ km $\mathbf{v}_A = (4\mathbf{i} - 6\mathbf{j})$ km/h at 9.30 a.m.
 $\mathbf{r}_B = (2\mathbf{i} - 18\mathbf{j})$ km $\mathbf{v}_B = (2\mathbf{i} + 7\mathbf{j})$ km/h at 9.00 a.m.
- 11** $\mathbf{r}_A = (-11\mathbf{i} + 4\mathbf{j})$ km $\mathbf{v}_A = (10\mathbf{i} - 4\mathbf{j})$ km/h at noon.
 $\mathbf{r}_B = (3\mathbf{i} - 5\mathbf{j})$ km $\mathbf{v}_B = (7\mathbf{i} + 5\mathbf{j})$ km/h at 12.30 p.m.

- 12** At 8 a.m. boats P, Q and R have position vectors (\mathbf{r}) and velocity vectors (\mathbf{v}) as follows:

$$\begin{aligned} \mathbf{r}_P &= (-23\mathbf{i} + 3\mathbf{j}) \text{ km.} & \mathbf{v}_P &= (18\mathbf{i} + 4\mathbf{j}) \text{ km/h.} \\ \mathbf{r}_Q &= (7\mathbf{i} + 30\mathbf{j}) \text{ km.} & \mathbf{v}_Q &= (12\mathbf{i} - 10\mathbf{j}) \text{ km/h.} \\ \mathbf{r}_R &= (32\mathbf{i} - 30\mathbf{j}) \text{ km.} & \mathbf{v}_R &= (2\mathbf{i} + 14\mathbf{j}) \text{ km/h.} \end{aligned}$$

- a** Prove that if the boats continue with these velocities two of them will collide, stating which two it will be, the time of collision and the position vector of its location.
b How far will the third boat be from the scene of the collision at the moment it occurs?



Shutterstock.com/MAGNIFIER



Vector equation of a straight line in the x - y plane

Suppose a ship is at the point with position vector $(2\mathbf{i} + 5\mathbf{j})$ km and is moving with a constant velocity of $(4\mathbf{i} + \mathbf{j})$ km/h.

At a time t hours later the ship will be at the point with position vector \mathbf{r} where

$$\mathbf{r} = (2\mathbf{i} + 5\mathbf{j}) + t(4\mathbf{i} + \mathbf{j}).$$

Let us now remove the context of a moving ship and simply consider the line through point A, position vector $2\mathbf{i} + 5\mathbf{j}$, and parallel to the vector $4\mathbf{i} + \mathbf{j}$.

Consider points B, C and D on this line and let point O be the origin (see diagram).

$$\begin{aligned} \text{B has position vector } \vec{OB} &= \vec{OA} + \vec{AB} \\ &= (2\mathbf{i} + 5\mathbf{j}) + 1(4\mathbf{i} + \mathbf{j}) \\ &= 6\mathbf{i} + 6\mathbf{j} \end{aligned}$$

$$\begin{aligned} \text{C has position vector } \vec{OC} &= \vec{OA} + \vec{AC} \\ &= (2\mathbf{i} + 5\mathbf{j}) + 2(4\mathbf{i} + \mathbf{j}) \\ &= 10\mathbf{i} + 7\mathbf{j} \end{aligned}$$

$$\begin{aligned} \text{D has position vector } \vec{OD} &= \vec{OA} + \vec{AD} \\ &= (2\mathbf{i} + 5\mathbf{j}) + (-0.5)(4\mathbf{i} + \mathbf{j}) \\ &= 4.5\mathbf{j} \end{aligned}$$

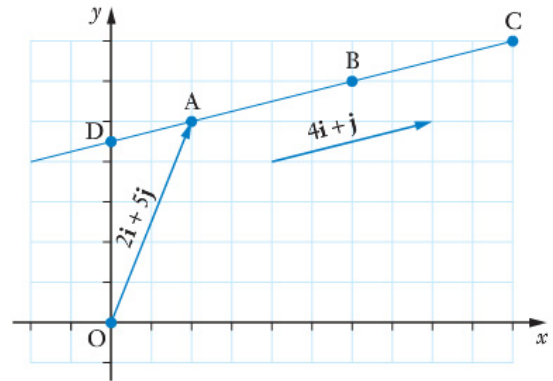

The position vector of every point on the line through A, position vector $2\mathbf{i} + 5\mathbf{j}$, and parallel to the vector $4\mathbf{i} + \mathbf{j}$ can be expressed in the form:

$$2\mathbf{i} + 5\mathbf{j} + \lambda(4\mathbf{i} + \mathbf{j}) \quad \text{for a suitable choice of the scalar, } \lambda.$$

For point A, $\lambda = 0$, for B, $\lambda = 1$, for C, $\lambda = 2$, for D, $\lambda = -0.5$.

To generalise: Every point on the line through A, position vector \mathbf{a} , and parallel to the vector \mathbf{b} has a position vector that can be expressed in the form:

$$\mathbf{r} = \mathbf{a} + \lambda\mathbf{b}$$

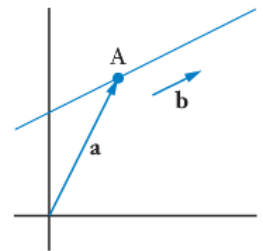

The equation:

$$\mathbf{r} = \mathbf{a} + \lambda\mathbf{b}$$

is

the vector equation of the line parallel to \mathbf{b} and through the point with position vector \mathbf{a} .

Every point on the line has a position vector that can be expressed in the form $\mathbf{a} + \lambda\mathbf{b}$ for some suitable value λ , and furthermore, any point not lying on the line cannot be expressed in this form.

EXAMPLE 3

- a** Find the vector equation of the line passing through the point A, position vector $2\mathbf{i} + 3\mathbf{j}$, parallel to the vector $4\mathbf{i} - 6\mathbf{j}$.
- b** Determine whether or not each of the following points lie on the line:
 B, position vector $10\mathbf{i} - 9\mathbf{j}$. C, position vector $8\mathbf{i} - 5\mathbf{j}$.

Solution

- a** The line through A, position vector \mathbf{a} , and parallel to \mathbf{b} has vector equation:

$$\mathbf{r} = \mathbf{a} + \lambda\mathbf{b}.$$

Thus the line through A, position vector $2\mathbf{i} + 3\mathbf{j}$, and parallel to $4\mathbf{i} - 6\mathbf{j}$ has vector equation

$$\mathbf{r} = 2\mathbf{i} + 3\mathbf{j} + \lambda(4\mathbf{i} - 6\mathbf{j}).$$

i.e.
$$\mathbf{r} = (2 + 4\lambda)\mathbf{i} + (3 - 6\lambda)\mathbf{j}$$

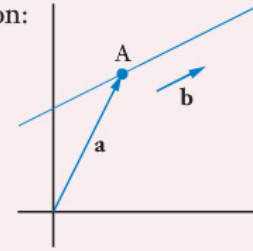

- b** If B, position vector $10\mathbf{i} - 9\mathbf{j}$, lies on there must exist some λ for which

$$\begin{aligned} \mathbf{r} &= (2 + 4\lambda)\mathbf{i} + (3 - 6\lambda)\mathbf{j} \\ 10\mathbf{i} - 9\mathbf{j} &= (2 + 4\lambda)\mathbf{i} + (3 - 6\lambda)\mathbf{j} \end{aligned}$$

i.e.
$$\begin{array}{ll} 10 = 2 + 4\lambda & \text{and} \\ \lambda = 2 & \text{and} \end{array} \quad \begin{array}{l} -9 = 3 - 6\lambda \\ \lambda = 2 \end{array}$$

Thus a suitable value of λ does exist.

Point B *does* lie on $\mathbf{r} = 2\mathbf{i} + 3\mathbf{j} + \lambda(4\mathbf{i} - 6\mathbf{j})$.

- If C, position vector $8\mathbf{i} - 5\mathbf{j}$, lies on there must exist some λ for which

$$\begin{aligned} \mathbf{r} &= (2 + 4\lambda)\mathbf{i} + (3 - 6\lambda)\mathbf{j} \\ 8\mathbf{i} - 5\mathbf{j} &= (2 + 4\lambda)\mathbf{i} + (3 - 6\lambda)\mathbf{j} \end{aligned}$$

i.e.
$$\begin{array}{ll} 8 = 2 + 4\lambda & \text{and} \\ \lambda = \frac{3}{2} & \text{and} \end{array} \quad \begin{array}{l} -5 = 3 - 6\lambda \\ \lambda = \frac{4}{3} \end{array}$$

Point C does *not* lie on $\mathbf{r} = 2\mathbf{i} + 3\mathbf{j} + \lambda(4\mathbf{i} - 6\mathbf{j})$.

It is important to realise that with the usual convention of \mathbf{i} being a unit vector in the positive x direction and \mathbf{j} a unit vector in the positive y direction, there is no conflict between:

- the vector equation of a straight line, $\mathbf{r} = \mathbf{a} + \lambda\mathbf{b}$
- the cartesian equation of a straight line, $y = mx + c$.

The position vector, \mathbf{r} , of any point on the line will obey the rule $\mathbf{r} = \mathbf{a} + \lambda\mathbf{b}$.

The cartesian coordinates (x, y) of any point on the line will obey $y = mx + c$.

This consistency between the vector equation of a line and the cartesian equation of the same line is demonstrated on the next page.



Consider the line L shown on the right.

This line passes through A, position vector $2\mathbf{i} + 2\mathbf{j}$ and is parallel to the vector $2\mathbf{i} - \mathbf{j}$.

Thus the vector equation of the line can be written:

$$\begin{aligned}\mathbf{r} &= 2\mathbf{i} + 2\mathbf{j} + \lambda(2\mathbf{i} - \mathbf{j}) \\ &= (2 + 2\lambda)\mathbf{i} + (2 - \lambda)\mathbf{j}\end{aligned}$$

Now consider some general point P, cartesian coordinates (x, y) , lying on this line. The position vector of P will be $x\mathbf{i} + y\mathbf{j}$.

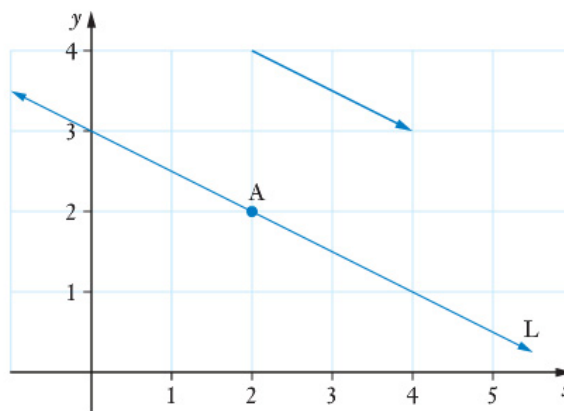

But point P lies on the line and so $x\mathbf{i} + y\mathbf{j} = (2 + 2\lambda)\mathbf{i} + (2 - \lambda)\mathbf{j}$

$$\text{Thus } x = 2 + 2\lambda \quad [1]$$

$$\text{and } y = 2 - \lambda \quad [2]$$

Eliminating λ from [1] and [2] gives $y = -\frac{1}{2}x + 3$.

This equation is exactly as we would expect for a line passing through $(0, 3)$ and with gradient -0.5 .

Thus, as stated, there is no conflict between the vector equation $\mathbf{r} = \mathbf{a} + \lambda\mathbf{b}$ and the cartesian equation $y = mx + c$.

- Note
- You may find it convenient for this work to write the vector $a\mathbf{i} + b\mathbf{j}$ in the matrix form $\begin{pmatrix} a \\ b \end{pmatrix}$.
 - Equations [1] and [2] above are called the **parametric equations** of the line and λ is called the **parameter**. It acts as a sort of ‘go-between’ linking x and y . It is the ‘interpreter’ through which they relate to each other.
 - Letters other than λ may be used for the parameter. Indeed if time is involved it makes sense to use t rather than λ .
 - We said that line L passed through A, position vector $2\mathbf{i} + 2\mathbf{j}$ and was parallel to $2\mathbf{i} - \mathbf{j}$ and wrote the vector equation as:

$$\mathbf{r} = 2\mathbf{i} + 2\mathbf{j} + \lambda(2\mathbf{i} - \mathbf{j}). \quad [3]$$

We could equally well have said that the line passed through the point with position vector $4\mathbf{i} + \mathbf{j}$ and was parallel to $2\mathbf{i} - \mathbf{j}$. We would then have written the vector equation as:

$$\mathbf{r} = 4\mathbf{i} + \mathbf{j} + \lambda(2\mathbf{i} - \mathbf{j}). \quad [4]$$

Though these equations may appear different both [3] and [4] define the same line. The position vector obtained by substituting a specific value of λ into [3] would be obtained by substituting $(\lambda - 1)$ into [4].

e.g. Substituting $\lambda = 2$ into equation [3] gives the position vector $6\mathbf{i}$. This same position vector is obtained when $\lambda = 1$ is substituted into [4].

Thus in some questions, when comparing your vector equation of a line with the one given in the answers, do not automatically assume that your answer, because it looks different, is wrong. It may simply be a different way, and equally acceptable way, of defining the same line.

EXAMPLE 4

Find **a** the vector equation, **b** the parametric equations and **c** the cartesian equation, of the line through the point with position vector $\begin{pmatrix} 3 \\ -4 \end{pmatrix}$, parallel to $\begin{pmatrix} 2 \\ 5 \end{pmatrix}$.

Solution

a The vector equation is $\mathbf{r} = \begin{pmatrix} 3 \\ -4 \end{pmatrix} + \lambda \begin{pmatrix} 2 \\ 5 \end{pmatrix}$ i.e. $\mathbf{r} = \begin{pmatrix} 3 + 2\lambda \\ -4 + 5\lambda \end{pmatrix}$.

b Considering the general point, position vector $\begin{pmatrix} x \\ y \end{pmatrix}$: $\begin{pmatrix} x \\ y \end{pmatrix} = \begin{pmatrix} 3 + 2\lambda \\ -4 + 5\lambda \end{pmatrix}$

Thus the parametric equations are $\begin{cases} x = 3 + 2\lambda \\ y = -4 + 5\lambda \end{cases}$

c Eliminating λ gives: $x = 3 + 2\left(\frac{y+4}{5}\right)$

i.e. $2y = 5x - 23$.

The cartesian equation is $2y = 5x - 23$.

Alternatively the cartesian equation could be found as follows:

If the line is parallel to $2\mathbf{i} + 5\mathbf{j}$ it must have gradient $\frac{5}{2}$.

Therefore the equation is of the form $y = 2.5x + c$

But line passes through $(3, -4)$, thus $-4 = 2.5(3) + c$ i.e. $c = -11.5$

The cartesian equation is $y = 2.5x - 11.5$.



EXAMPLE 5

Find the vector equation of the line passing through the point A, position vector $3\mathbf{i} + 7\mathbf{j}$, and B, position vector $8\mathbf{i} + 2\mathbf{j}$.

Solution

The line is parallel to \overrightarrow{AB} .

$$\begin{aligned} \text{Now } \overrightarrow{AB} &= \overrightarrow{AO} + \overrightarrow{OB} \\ &= -\overrightarrow{OA} + \overrightarrow{OB} \\ &= -(3\mathbf{i} + 7\mathbf{j}) + (8\mathbf{i} + 2\mathbf{j}) \\ &= 5\mathbf{i} - 5\mathbf{j} \end{aligned}$$

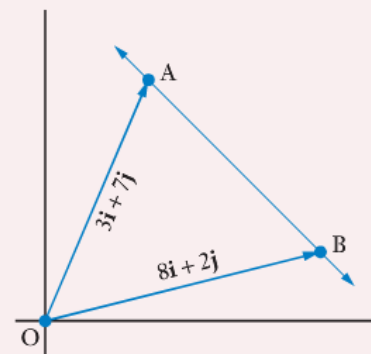

The line is parallel to $5\mathbf{i} - 5\mathbf{j}$ and passes through point A, position vector $3\mathbf{i} + 7\mathbf{j}$. Thus the vector equation of the line is $\mathbf{r} = 3\mathbf{i} + 7\mathbf{j} + \lambda(5\mathbf{i} - 5\mathbf{j})$.

i.e. $\mathbf{r} = (3 + 5\lambda)\mathbf{i} + (7 - 5\lambda)\mathbf{j}$



In the previous example, instead of being given a vector parallel to the line and the position vector of a point on the line, we were given the position vectors of two points lying on the line.

The general situation is shown on the right with points A and B lying on the line, position vectors \mathbf{a} and \mathbf{b} respectively.

The line is parallel to \overrightarrow{AB} , and

$$\begin{aligned}\overrightarrow{AB} &= -\mathbf{a} + \mathbf{b} \\ &= \mathbf{b} - \mathbf{a}\end{aligned}$$

Thus the line passes through point A, position vector \mathbf{a} , and is parallel to $\mathbf{b} - \mathbf{a}$.

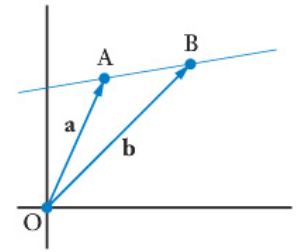

The vector equation of the line through points A and B, position vectors \mathbf{a} and \mathbf{b} respectively is therefore:

$$\mathbf{r} = \mathbf{a} + \lambda(\mathbf{b} - \mathbf{a})$$

The answer to the previous example could have been obtained by direct substitution of $\mathbf{a} = 3\mathbf{i} + 7\mathbf{j}$ and $\mathbf{b} = 8\mathbf{i} + 2\mathbf{j}$ into the above formula.

The equation:

$$\mathbf{r} = \mathbf{a} + \lambda(\mathbf{b} - \mathbf{a})$$

is the vector equation of the line through points A and B, position vectors \mathbf{a} and \mathbf{b} respectively.

Exercise 4B

For questions **1** to **6** find the vector equation of the line parallel to \mathbf{b} and through the point with position vector \mathbf{a} .

1 $\mathbf{a} = 2\mathbf{i} + 3\mathbf{j}, \quad \mathbf{b} = 5\mathbf{i} - \mathbf{j}.$

2 $\mathbf{a} = 3\mathbf{i} - 2\mathbf{j}, \quad \mathbf{b} = \mathbf{i} + \mathbf{j}.$

3 $\mathbf{a} = 5\mathbf{i} + 3\mathbf{j}, \quad \mathbf{b} = -2\mathbf{j}.$

4 $\mathbf{a} = 5\mathbf{j}, \quad \mathbf{b} = 3\mathbf{i} - 10\mathbf{j}.$

5 $\mathbf{a} = \begin{pmatrix} 2 \\ -3 \end{pmatrix}, \quad \mathbf{b} = \begin{pmatrix} 1 \\ 4 \end{pmatrix}.$

6 $\mathbf{a} = \begin{pmatrix} 0 \\ 5 \end{pmatrix}, \quad \mathbf{b} = \begin{pmatrix} 5 \\ 0 \end{pmatrix}.$

For questions **7** to **12** find the vector equation of the line passing through the point with position vector \mathbf{a} and the point with position vector \mathbf{b} .

7 $\mathbf{a} = 5\mathbf{i} + 3\mathbf{j}, \quad \mathbf{b} = 2\mathbf{i} - \mathbf{j}.$

8 $\mathbf{a} = 6\mathbf{i} + 7\mathbf{j}, \quad \mathbf{b} = -5\mathbf{i} + 2\mathbf{j}.$

9 $\mathbf{a} = \begin{pmatrix} -6 \\ 3 \end{pmatrix}, \quad \mathbf{b} = \begin{pmatrix} 2 \\ 4 \end{pmatrix}$

10 $\mathbf{a} = \begin{pmatrix} 1 \\ -3 \end{pmatrix}, \quad \mathbf{b} = \begin{pmatrix} -3 \\ 1 \end{pmatrix}$

11 $\mathbf{a} = \begin{pmatrix} 1 \\ 4 \end{pmatrix}, \quad \mathbf{b} = \begin{pmatrix} -1 \\ 9 \end{pmatrix}$

12 $\mathbf{a} = \begin{pmatrix} 5 \\ 0 \end{pmatrix}, \quad \mathbf{b} = \begin{pmatrix} -1 \\ -4 \end{pmatrix}$

13 Points A, B and C lie on the line $\mathbf{r} = 2\mathbf{i} + 3\mathbf{j} + \lambda(\mathbf{i} - 4\mathbf{j})$ and have position vectors given by $\lambda = -1$, $\lambda = 1$ and $\lambda = 2$ respectively.

Find **a** \vec{AB} , **b** $|\vec{BC}|$, **c** $\vec{AB} : \vec{BC}$.

14 Find **a** the vector equation, **b** the parametric equations and **c** the cartesian equation of the line passing through the point A, position vector $5\mathbf{i} - \mathbf{j}$, and parallel to $7\mathbf{i} + 2\mathbf{j}$.

15 Find **a** the vector equation, **b** the parametric equations and **c** the cartesian equation of the line passing through the point A, position vector $\begin{pmatrix} 2 \\ -1 \end{pmatrix}$, and parallel to $\begin{pmatrix} -3 \\ 4 \end{pmatrix}$.

16 Find **a** the vector equation, **b** the parametric equations and **c** the cartesian equation of the line passing through point A, position vector $\begin{pmatrix} 0 \\ 3 \end{pmatrix}$, and parallel to $\begin{pmatrix} 7 \\ -8 \end{pmatrix}$.

17 Find **a** the vector equation and **b** the cartesian equation of the line with parametric equations $x = 2 - 3\lambda$, $y = -5 + 2\lambda$.

18 Points D, E and F lie on the line $\mathbf{r} = \begin{pmatrix} 2 \\ -1 \end{pmatrix} + \lambda \begin{pmatrix} -1 \\ 3 \end{pmatrix}$ and have position vectors given by $\lambda = -1$, $\lambda = 2$ and $\lambda = 3$ respectively.

Find **a** \vec{EF} , **b** \vec{ED} , **c** $|\vec{DE}|$,
d $\vec{DE} : \vec{EF}$, **e** $\vec{DE} : \vec{FE}$, **f** $|\vec{DE}| : |\vec{FE}|$.

19 Find the vector equation of the line passing through the point A, which has position vector $7\mathbf{i} - 2\mathbf{j}$, and which is parallel to the vector $-2\mathbf{i} + 6\mathbf{j}$.

Determine whether each of the following points lie on the line.

B, position vector $\mathbf{i} + 16\mathbf{j}$.

C, position vector $2\mathbf{i} + 13\mathbf{j}$.

D, position vector $8\mathbf{i} - 7\mathbf{j}$.

E, position vector $-2\mathbf{i} + 5\mathbf{j}$.

20 Find the vector equation of the line passing through the point F, position vector $\begin{pmatrix} 4 \\ -9 \end{pmatrix}$, and which is parallel to the vector $\begin{pmatrix} -1 \\ 2 \end{pmatrix}$.

Determine whether each of the following points lie on the line.

G, position vector $\begin{pmatrix} 5 \\ 9 \end{pmatrix}$.

H, position vector $\begin{pmatrix} 0 \\ -1 \end{pmatrix}$.

I, position vector $\begin{pmatrix} -3 \\ 5 \end{pmatrix}$.



- 21** All of the points A to F, with position vectors as given below, lie on the line

$$\mathbf{r} = \begin{pmatrix} 3 \\ -1 \end{pmatrix} + \lambda \begin{pmatrix} 6 \\ 8 \end{pmatrix}.$$

A, position vector $-3\mathbf{i} + a\mathbf{j}$.

B, position vector $b\mathbf{i} + 23\mathbf{j}$.

C, position vector $\langle -9, c \rangle$.

D, position vector $\langle d, -21 \rangle$.

E, position vector $\begin{pmatrix} 12 \\ e \end{pmatrix}$.

F, position vector $\begin{pmatrix} f \\ f \end{pmatrix}$.

Determine the values of a, b, c, d, e and f .

- 22** Find the vector equation of the line passing through the point with position vector $5\mathbf{i} - 6\mathbf{j}$ and parallel to the line $\mathbf{r} = (2 + \lambda)\mathbf{i} + (3 - \lambda)\mathbf{j}$.

- 23** Find the vector equation of the line passing through the point with position vector $\begin{pmatrix} 6 \\ 5 \end{pmatrix}$ and parallel to the line $\mathbf{r} = \begin{pmatrix} 2 + 3\lambda \\ 1 - 4\lambda \end{pmatrix}$.

- 24** A ship travels with constant velocity $(6\mathbf{i} - 10\mathbf{j})$ km/h and passes through the point with position vector $(2\mathbf{i} + 12\mathbf{j})$ km. Find the cartesian equation of the path of the ship.

- 25** The line $\mathbf{r} = 2\mathbf{i} + 8\mathbf{j} + \lambda(\mathbf{i} - 2\mathbf{j})$ cuts the x -axis at A and the y -axis at B. Find the position vectors of A and B.

- 26** The line $\mathbf{r} = \begin{pmatrix} 5 \\ -4 \end{pmatrix} + \lambda \begin{pmatrix} 2 \\ -1 \end{pmatrix}$ cuts the x -axis at A and passes through B, position vector $\begin{pmatrix} 11 \\ c \end{pmatrix}$. Find the position vector of A and the value of c .

- 27** Points A, B, C and D are collinear and have position vectors $2\mathbf{i} + 3\mathbf{j}$, $b\mathbf{i} + 7\mathbf{j}$, $5\mathbf{i} - 4\mathbf{j}$, and $-2\mathbf{i} + d\mathbf{j}$ respectively. Find the vector equation of the line through the four points and the values of b and d .

- 28** The vector equations $\mathbf{r} = \begin{pmatrix} 5 \\ 3 \end{pmatrix} + \lambda \begin{pmatrix} 1 \\ 4 \end{pmatrix}$ and $\mathbf{r} = \begin{pmatrix} 9 \\ d \end{pmatrix} + \mu \begin{pmatrix} 2 \\ c \end{pmatrix}$ represent the same straight line. Find the values of c and d .

- 29** The vector equations $\mathbf{r} = \mathbf{i} - 3\mathbf{j} + \lambda(3\mathbf{i} + 4\mathbf{j})$ and $\mathbf{r} = e\mathbf{i} + 5\mathbf{j} + \mu(\mathbf{i} + f\mathbf{j})$ represent the same straight line. Find the values of e and f .

- 30** Three sets of parametric equations are given below. Which is the 'odd set out' and why?

[1] $\begin{cases} x = 1 + 2\lambda \\ y = \lambda + 3 \end{cases}$

[2] $\begin{cases} x = 2\lambda - 2 \\ y = 1 + \lambda \end{cases}$

[3] $\begin{cases} x = 8 + 2\lambda \\ y = 6 + \lambda \end{cases}$

Use the concept of the **scalar product** of two vectors for each of the following questions.
(See the *Preliminary work* section if you need to refresh your memory of this concept.)

31 Prove that the lines L_1 and L_2 are perpendicular given that:

$$L_1 \text{ has equation } \mathbf{r} = \begin{pmatrix} 2 \\ 4 \end{pmatrix} + \lambda \begin{pmatrix} -1 \\ 3 \end{pmatrix} \text{ and } L_2 \text{ has equation } \mathbf{r} = \begin{pmatrix} -3 \\ 1 \end{pmatrix} + \mu \begin{pmatrix} 6 \\ 2 \end{pmatrix}.$$

32 Line L_1 has vector equation $\mathbf{r} = \begin{pmatrix} 2 \\ -1 \end{pmatrix} + \lambda \begin{pmatrix} 3 \\ 2 \end{pmatrix}$. Find the vector equation of the line perpendicular to L_1 and passing through the point A, position vector $\begin{pmatrix} 4 \\ 3 \end{pmatrix}$.

33 Find to the nearest degree the acute angle between the lines L_1 and L_2 if L_1 has equation $\mathbf{r} = \begin{pmatrix} 2 \\ 3 \end{pmatrix} + \lambda \begin{pmatrix} 1 \\ -4 \end{pmatrix}$ and L_2 has equation $\mathbf{r} = \begin{pmatrix} 2 \\ -1 \end{pmatrix} + \mu \begin{pmatrix} 2 \\ 1 \end{pmatrix}$.

Point of intersection of two straight lines

Consider the two lines

$$L_1: \quad \mathbf{r} = \begin{pmatrix} 7 \\ 17 \end{pmatrix} + \lambda \begin{pmatrix} 7 \\ -2 \end{pmatrix}, \quad L_2: \quad \mathbf{r} = \begin{pmatrix} 16 \\ 3 \end{pmatrix} + \mu \begin{pmatrix} 3 \\ 2 \end{pmatrix}$$

The lines are straight, and not parallel. (How do we know they are not parallel?) Therefore they must intersect somewhere.

The point common to both lines will be such that

$$\begin{pmatrix} 7 \\ 17 \end{pmatrix} + \lambda \begin{pmatrix} 7 \\ -2 \end{pmatrix} = \begin{pmatrix} 16 \\ 3 \end{pmatrix} + \mu \begin{pmatrix} 3 \\ 2 \end{pmatrix}$$

$$\text{i.e.} \quad \begin{cases} 7 + 7\lambda = 16 + 3\mu \\ 17 - 2\lambda = 3 + 2\mu \end{cases}$$

Solving simultaneously gives $\lambda = 3$ and $\mu = 4$

$$\text{With } \lambda = 3 \text{ line } L_1 \text{ gives } \mathbf{r} = \begin{pmatrix} 7 \\ 17 \end{pmatrix} + 3 \begin{pmatrix} 7 \\ -2 \end{pmatrix} \quad \text{i.e.} \quad \mathbf{r} = \begin{pmatrix} 28 \\ 11 \end{pmatrix}.$$

$$\text{With } \mu = 4 \text{ line } L_2 \text{ gives } \mathbf{r} = \begin{pmatrix} 16 \\ 3 \end{pmatrix} + 4 \begin{pmatrix} 3 \\ 2 \end{pmatrix} \quad \text{i.e.} \quad \mathbf{r} = \begin{pmatrix} 28 \\ 11 \end{pmatrix}.$$

Lines L_1 and L_2 intersect at the point with position vector $28\mathbf{i} + 11\mathbf{j}$.

The next two examples show this same approach applied to determining whether two moving objects collide, a situation encountered at the beginning of this chapter.



EXAMPLE 6

At time $t = 0$ seconds the position vectors (\mathbf{r} m) and velocity vectors (\mathbf{v} m/s) of two particles A and B are as follows:

$$\mathbf{r}_A = 4\mathbf{i} + 20\mathbf{j}$$

$$\mathbf{r}_B = 5\mathbf{i} + 4\mathbf{j}$$

$$\mathbf{v}_A = \mathbf{i} - \mathbf{j}$$

$$\mathbf{v}_B = \mathbf{i} + 2\mathbf{j}$$

Determine whether, in the subsequent motion, the paths of the particles cross (or meet). If they do, determine the position vector of this point and determine if a collision between the particles is involved.

Solution

At time $t_1, t_1 > 0$, particle A will have position vector $\mathbf{r} = \begin{pmatrix} 4 \\ 20 \end{pmatrix} + t_1 \begin{pmatrix} 1 \\ -1 \end{pmatrix}$.

At time $t_2, t_2 > 0$, particle B will have position vector $\mathbf{r} = \begin{pmatrix} 5 \\ 4 \end{pmatrix} + t_2 \begin{pmatrix} 1 \\ 2 \end{pmatrix}$.

For these position vectors to be equal: $\begin{pmatrix} 4 \\ 20 \end{pmatrix} + t_1 \begin{pmatrix} 1 \\ -1 \end{pmatrix} = \begin{pmatrix} 5 \\ 4 \end{pmatrix} + t_2 \begin{pmatrix} 1 \\ 2 \end{pmatrix}$

i.e.
$$\begin{cases} 4 + t_1 = 5 + t_2 \\ 20 - t_1 = 4 + 2t_2 \end{cases}$$

Solving simultaneously gives $t_1 = 6$ and $t_2 = 5$.

With $t_1 = 6$ particle A has position vector $\mathbf{r} = \begin{pmatrix} 4 \\ 20 \end{pmatrix} + 6 \begin{pmatrix} 1 \\ -1 \end{pmatrix}$ i.e. $\mathbf{r} = \begin{pmatrix} 10 \\ 14 \end{pmatrix}$.

With $t_2 = 5$ particle B has position vector $\mathbf{r} = \begin{pmatrix} 5 \\ 4 \end{pmatrix} + 5 \begin{pmatrix} 1 \\ 2 \end{pmatrix}$ i.e. $\mathbf{r} = \begin{pmatrix} 10 \\ 14 \end{pmatrix}$.

Thus particles A and B each pass through the point with position vector $10\mathbf{i} + 14\mathbf{j}$, but at different times, both greater than zero.

Thus in the subsequent motion the paths of the particles cross at the point with position vector $10\mathbf{i} + 14\mathbf{j}$ but a collision is not involved.

EXAMPLE 7

At time $t = 0$ seconds the position vectors (\mathbf{r} m) and velocity vectors (\mathbf{v} m/s) of two particles A and B are as given below:

$$\mathbf{r}_A = 9\mathbf{i} + 55\mathbf{j}$$

$$\mathbf{r}_B = 24\mathbf{i} - 5\mathbf{j}$$

$$\mathbf{v}_A = -\mathbf{i} - 3\mathbf{j}$$

$$\mathbf{v}_B = -2\mathbf{i} + \mathbf{j}$$

Determine whether, in the subsequent motion, the paths of the particles cross (or meet). If they do, determine the position vector of this point and determine if a collision between the particles is involved.

Solution

At time $t_1, t_1 > 0$, particle A will have position vector $\mathbf{r} = \begin{pmatrix} 9 \\ 55 \end{pmatrix} + t_1 \begin{pmatrix} -1 \\ -3 \end{pmatrix}$.

At time $t_2, t_2 > 0$, particle B will have position vector $\mathbf{r} = \begin{pmatrix} 24 \\ -5 \end{pmatrix} + t_2 \begin{pmatrix} -2 \\ 1 \end{pmatrix}$.



For these position vectors to be equal:

$$\begin{pmatrix} 9 \\ 55 \end{pmatrix} + t_1 \begin{pmatrix} -1 \\ -3 \end{pmatrix} = \begin{pmatrix} 24 \\ -5 \end{pmatrix} + t_2 \begin{pmatrix} -2 \\ 1 \end{pmatrix}$$

i.e.,

$$\begin{cases} 9 - t_1 = 24 - 2t_2 \\ 55 - 3t_1 = -5 + t_2 \end{cases}$$

Solving simultaneously gives $t_1 = 15$ and $t_2 = 15$.

In the subsequent motion, i.e. $t > 0$, the paths of the particles meet.

With $t_1 = 15$ particle A has position vector $\mathbf{r} = \begin{pmatrix} 9 \\ 55 \end{pmatrix} + 15 \begin{pmatrix} -1 \\ -3 \end{pmatrix}$ i.e. $\mathbf{r} = \begin{pmatrix} -6 \\ 10 \end{pmatrix}$.

With $t_2 = 15$ particle B has position vector $\mathbf{r} = \begin{pmatrix} 24 \\ -5 \end{pmatrix} + 15 \begin{pmatrix} -2 \\ 1 \end{pmatrix}$ i.e. $\mathbf{r} = \begin{pmatrix} -6 \\ 10 \end{pmatrix}$.

Thus particles A and B are each at the point with position vector $-6\mathbf{i} + 10\mathbf{j}$ at time $t = 15$ seconds. A collision is involved.

Exercise 4C

1 Find the position vector of the point of intersection of lines L_1 and L_2 , vector equations,

$$L_1: \mathbf{r} = 14\mathbf{i} - \mathbf{j} + \lambda(5\mathbf{i} - 4\mathbf{j})$$

$$L_2: \mathbf{r} = 9\mathbf{i} - 4\mathbf{j} + \mu(-4\mathbf{i} + 6\mathbf{j})$$

2 Find the position vector of the point of intersection of lines L_1 and L_2 , vector equations,

$$L_1: \mathbf{r} = \begin{pmatrix} -3 \\ 4 \end{pmatrix} + \lambda \begin{pmatrix} 1 \\ -1 \end{pmatrix},$$

$$L_2: \mathbf{r} = \begin{pmatrix} -10 \\ 2 \end{pmatrix} + \mu \begin{pmatrix} -4 \\ 1 \end{pmatrix}.$$

3 Find the position vector of the point of intersection of lines L_1 and L_2 , vector equations,

$$L_1: \mathbf{r} = \begin{pmatrix} -1 \\ 0 \end{pmatrix} + \lambda \begin{pmatrix} 4 \\ -10 \end{pmatrix},$$

$$L_2: \mathbf{r} = \begin{pmatrix} -5 \\ -9 \end{pmatrix} + \mu \begin{pmatrix} 1 \\ 7 \end{pmatrix}.$$

For each of questions **4**, **5** and **6** the given information shows the position vectors (\mathbf{r} m) and velocity vectors (\mathbf{v} m/s) of two particles A and B at time $t = 0$ seconds.

In each case determine whether, in the subsequent motion, the paths of the particles cross (or meet), and, if they do, determine the position vector of this point and determine if a collision between the particles is involved, explaining your answer.

4 $\mathbf{r}_A = 16\mathbf{i}$

$$\mathbf{v}_A = 3\mathbf{i} + 2\mathbf{j}$$

$$\mathbf{r}_B = -\mathbf{i} + 6\mathbf{j}$$

$$\mathbf{v}_B = 2\mathbf{i} - 3\mathbf{j}$$

5 $\mathbf{r}_A = \mathbf{i} + 4\mathbf{j}$

$$\mathbf{v}_A = 4\mathbf{i} + \mathbf{j}$$

$$\mathbf{r}_B = 37\mathbf{i} - 20\mathbf{j}$$

$$\mathbf{v}_B = -2\mathbf{i} + 5\mathbf{j}$$

6 $\mathbf{r}_A = \mathbf{i} + 19\mathbf{j}$

$$\mathbf{v}_A = 2\mathbf{i} - \mathbf{j}$$

$$\mathbf{r}_B = 3\mathbf{i} + 8\mathbf{j}$$

$$\mathbf{v}_B = 3\mathbf{i} + \mathbf{j}$$

Scalar product form of the equation of a straight line in the x - y plane

- If we are given vector \mathbf{a} , the position vector of one point lying on a straight line, and vector \mathbf{b} , a vector parallel to the line, then the line is uniquely defined. This enabled us to write the equation of the line as

$$\mathbf{r} = \mathbf{a} + \lambda\mathbf{b}.$$

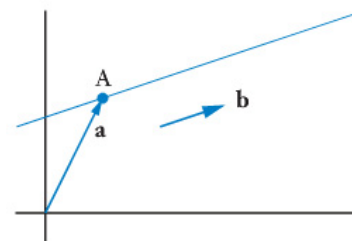

- If we are given the position vectors of two points lying on the line, the line is again uniquely defined.

This enabled us to write the equation of the line in the form

$$\mathbf{r} = \mathbf{a} + \lambda(\mathbf{c} - \mathbf{a}).$$

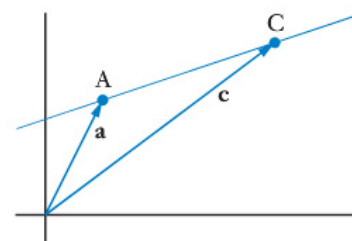

- A straight line in the \mathbf{i} - \mathbf{j} plane (or x - y plane) may also be uniquely defined by stating vector \mathbf{a} , the position vector of one point lying on the line, and vector \mathbf{n} , a vector in the \mathbf{i} - \mathbf{j} plane and perpendicular to the line.

If \mathbf{r} is the position vector of a general point lying on the line then $(\mathbf{r} - \mathbf{a})$ is parallel to the line.

Thus $(\mathbf{r} - \mathbf{a}) \cdot \mathbf{n} = 0$
 i.e. $\mathbf{r} \cdot \mathbf{n} - \mathbf{a} \cdot \mathbf{n} = 0$
 giving $\mathbf{r} \cdot \mathbf{n} = \mathbf{a} \cdot \mathbf{n}$

With \mathbf{a} and \mathbf{n} known, $\mathbf{a} \cdot \mathbf{n}$ is a constant and the equation can be written $\mathbf{r} \cdot \mathbf{n} = c$.

Any point having a position vector that satisfies the equation $\mathbf{r} \cdot \mathbf{n} = c$ will lie on the line.

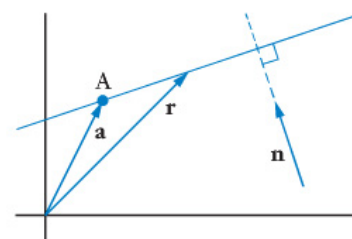

In this chapter, where we are only considering coordinates and vectors in two-dimensional space then:

$\mathbf{r} \cdot \mathbf{n} = \mathbf{a} \cdot \mathbf{n}$ (or $\mathbf{r} \cdot \mathbf{n} = c$) is the vector equation of a line passing through the point with position vector \mathbf{a} and perpendicular to the vector \mathbf{n} .

$\mathbf{r} \cdot \mathbf{n} = \mathbf{a} \cdot \mathbf{n}$ (or $\mathbf{r} \cdot \mathbf{n} = c$) is the **scalar product form** of the vector equation of the line. It may also be referred to as the **normal form** of the vector equation of the line. Here the word normal is used because of its geometrical meaning of 'perpendicular' rather than its common meaning of 'usual'.

However, as we will see in the next chapter, if we are considering three-dimensional space, this *scalar product form* defines a plane, not a line.



EXAMPLE 8

Find **a** the vector equation in scalar product form,
and **b** the cartesian equation,
of a line perpendicular to $5\mathbf{i} - \mathbf{j}$ and passing through point A, position vector $2\mathbf{i} + 3\mathbf{j}$.

Solution

a The vector equation of a line passing through the point with position vector \mathbf{a} and perpendicular to the vector \mathbf{n} is:

$$\mathbf{r} \cdot \mathbf{n} = \mathbf{a} \cdot \mathbf{n}.$$

Thus the vector equation of a line passing through the point with a position vector of $2\mathbf{i} + 3\mathbf{j}$ and perpendicular to $5\mathbf{i} - \mathbf{j}$ is:

$$\begin{aligned}\mathbf{r} \cdot (5\mathbf{i} - \mathbf{j}) &= (2\mathbf{i} + 3\mathbf{j}) \cdot (5\mathbf{i} - \mathbf{j}) \\ &= (2)(5) + (3)(-1) \\ &= 7\end{aligned}$$

The vector equation of a line perpendicular to $5\mathbf{i} - \mathbf{j}$ and passing through point A, position vector $2\mathbf{i} + 3\mathbf{j}$, is $\mathbf{r} \cdot (5\mathbf{i} - \mathbf{j}) = 7$.

b If a general point on the line has position vector $\mathbf{r} = x\mathbf{i} + y\mathbf{j}$ then:

$$\begin{aligned}(x\mathbf{i} + y\mathbf{j}) \cdot (5\mathbf{i} - \mathbf{j}) &= 7 \\ \text{Thus } (x)(5) + (y)(-1) &= 7 \\ \text{i.e. } 5x - y &= 7\end{aligned}$$

The cartesian equation of a line perpendicular to $5\mathbf{i} - \mathbf{j}$ and passing through point A, position vector $2\mathbf{i} + 3\mathbf{j}$, is $5x - y = 7$ (i.e. $y = 5x - 7$).

EXAMPLE 9

Find the cartesian equation of the line perpendicular to the vector $4\mathbf{i} - 3\mathbf{j}$ and passing through point A (1, 4).

Solution

The normal form of the vector equation is:

$$\begin{aligned}\mathbf{r} \cdot (4\mathbf{i} - 3\mathbf{j}) &= (\mathbf{i} + 4\mathbf{j}) \cdot (4\mathbf{i} - 3\mathbf{j}) \\ &= (1)(4) + (4)(-3) \\ &= -8\end{aligned}$$

Writing \mathbf{r} as $x\mathbf{i} + y\mathbf{j}$ we have

$$\begin{aligned}(x\mathbf{i} + y\mathbf{j}) \cdot (4\mathbf{i} - 3\mathbf{j}) &= -8 \\ (x)(4) + (y)(-3) &= -8 \\ 4x - 3y &= -8\end{aligned}$$

The required cartesian equation is $4x - 3y = -8$.

Exercise 4D

1 Find the normal form (i.e. scalar product form) of the vector equation of the line perpendicular to $3\mathbf{i} + 4\mathbf{j}$ and passing through point A, position vector $2\mathbf{i} + 3\mathbf{j}$.

2 Find the normal form (i.e. scalar product form) of the vector equation of the line perpendicular to $5\mathbf{i} - \mathbf{j}$ and passing through point A, position vector $-\mathbf{i} + 7\mathbf{j}$.

3 For each of the points A to F given below state whether or not the point lies on the line $\mathbf{r} \cdot (\mathbf{i} + 2\mathbf{j}) = 12$.

Point A, position vector $6\mathbf{j}$.

Point B, position vector $6\mathbf{i} + 3\mathbf{j}$.

Point C, position vector $10\mathbf{i}$.

Point D, position vector $3\mathbf{i} + 6\mathbf{j}$.

Point E, position vector $-4\mathbf{i} + 8\mathbf{j}$.

Point F, position vector $14\mathbf{i} - \mathbf{j}$.

4 Each of the points U to Z given below lies on the line with vector equation:

$$\mathbf{r} \cdot \begin{pmatrix} 2 \\ 3 \end{pmatrix} = 10.$$

Point U, position vector $u\mathbf{i} + 2\mathbf{j}$.

Point V, position vector $-10\mathbf{i} + v\mathbf{j}$.

Point W, position vector $w\mathbf{i} - 4\mathbf{j}$.

Point X, position vector $x\mathbf{i} - 2\mathbf{j}$.

Point Y, position vector $5\mathbf{i} + y\mathbf{j}$.

Point Z, position vector $z\mathbf{i} + 6\mathbf{j}$.

Determine u, v, w, x, y and z .

5 A line is perpendicular to the vector $5\mathbf{i} + 2\mathbf{j}$ and passes through point A, position vector $\mathbf{i} + \mathbf{j}$.

Find **a** the vector equation of the line in scalar product form,

b the cartesian equation of the line.

6 A line is perpendicular to the vector $2\mathbf{i} + 5\mathbf{j}$ and passes through point A, position vector $2\mathbf{i} - \mathbf{j}$.

Find **a** the vector equation of the line in scalar product form,

b the cartesian equation of the line.

7 Prove that $\mathbf{r} = 2\mathbf{i} + 3\mathbf{j} + \lambda(\mathbf{i} - 4\mathbf{j})$ and $\mathbf{r} \cdot (8\mathbf{i} + 2\mathbf{j}) = 5$ are parallel lines.

8 Find the cartesian equation of the line perpendicular to the vector $8\mathbf{i} + 5\mathbf{j}$ and passing through the point $(-1, 3)$.

9 Prove that lines L_1 and L_2 are perpendicular given that:

L_1 has equation: $\mathbf{r} = 5\mathbf{i} + 2\mathbf{j} + \lambda(3\mathbf{i} - 2\mathbf{j})$.

L_2 has equation: $\mathbf{r} \cdot (6\mathbf{i} - 4\mathbf{j}) = -4$.

Vector equations of curves in the x-y plane

Earlier in this chapter we saw that the **vector equation** $\mathbf{r} = 2\mathbf{i} + 2\mathbf{j} + \lambda(2\mathbf{i} - \mathbf{j})$

leads to the **parametric equations**

$$\begin{cases} x = 2 + 2\lambda \\ y = 2 - \lambda \end{cases}$$

and, by eliminating λ , the **cartesian equation**

$$y = -\frac{1}{2}x + 3,$$

the vector equation, the parametric equation and the cartesian equation all representing the same straight line.

Curves can be similarly represented as vector equations and parametric equations, and, by eliminating the parameter, the cartesian equations we are already familiar with.

For example, the vector equation

$$\mathbf{r} = (t + 2)\mathbf{i} + 3t^2\mathbf{j}$$

leads to the parametric equations

$$\begin{cases} x = t + 2 \\ y = 3t^2 \end{cases}$$

and, by eliminating t , the cartesian equation

$$y = 3(x - 2)^2.$$

Some calculators can display the graphs of functions defined parametrically.

xt1=t+2
yt1=3 · t²

xt2:
yt2:

xt3:
yt3:

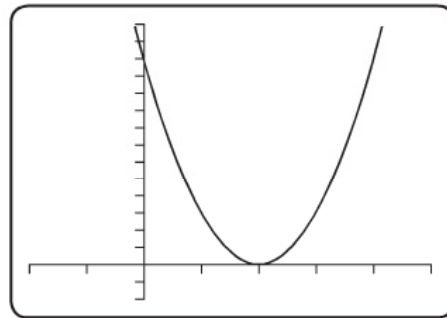

Vector equations of circles in the x-y plane

With a bit of thought, and especially considering the work of an earlier chapter with regard to regions in the complex plane, you should be able to predict the form of the vector equation of a circle.

The vector equation of a circle will be a rule involving \mathbf{r} , the position vector of a point on the circle, that will be true for the position vectors of all points lying on the circle, and not true for the position vectors of any points not lying on the circle.

Consider some general point R lying on a circle, centre at the origin and radius a , and let the position vector of R be \mathbf{r} . For R to lie on the circle it must be the case that

$$|\mathbf{r}| = a$$

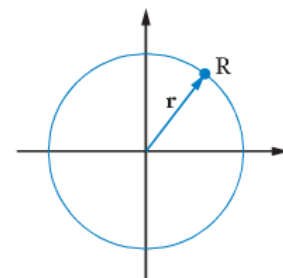

The vector equation $|\mathbf{r}| = a$ is the **vector equation** of the circle centre $(0, 0)$, radius a .

If the point R has the general cartesian coordinates (x, y) then $\mathbf{r} = x\mathbf{i} + y\mathbf{j}$.

Thus $|\mathbf{x}\mathbf{i} + \mathbf{y}\mathbf{j}| = a$, i.e.

$$x^2 + y^2 = a^2$$

This is the **cartesian equation** of a circle centre $(0, 0)$ and radius a .

Note: We can write the equation of a circle centre at $(0, 0)$ and radius a in parametric form as:

$$\begin{cases} x = a \cos \theta \\ y = a \sin \theta \end{cases}$$

The reader should confirm that using the trigonometric identity

$$\sin^2 \theta + \cos^2 \theta = 1$$

to eliminate the parameter θ , gives the cartesian equation $x^2 + y^2 = a^2$.

Consider a circle, again with radius a , but now with its centre not at $(0, 0)$, but instead at the point with position vector $\mathbf{d} (= p\mathbf{i} + q\mathbf{j})$.

Consider some general point R, position vector \mathbf{r} , lying on the circle. We require a rule that will be true for the position vectors of all points lying on the circle and not true for points not lying on the circle.

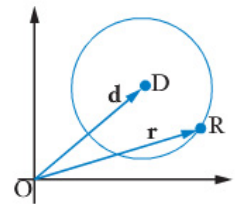

If D is the centre of the circle then, for R to lie on the circle, we must have $|\overrightarrow{DR}| = a$.

i.e.

$$|\mathbf{r} - \mathbf{d}| = a$$

This is the **vector equation** of a circle of radius a and with its centre at the point with position vector \mathbf{d} .

If the point R has the general cartesian coordinates (x, y) then $\mathbf{r} = x\mathbf{i} + y\mathbf{j}$.

If the centre of the circle has coordinates (p, q) then $\mathbf{d} = p\mathbf{i} + q\mathbf{j}$.

Thus $|(x\mathbf{i} + y\mathbf{j}) - (p\mathbf{i} + q\mathbf{j})| = a$

$$|(x - p)\mathbf{i} + (y - q)\mathbf{j}| = a$$

i.e.

$$(x - p)^2 + (y - q)^2 = a^2$$

This is the **cartesian equation** of a circle centre (p, q) and radius a (as the *Preliminary work* section, and chapter two, reminded us).

Note: We can write the equation of a circle centre at (p, q) and radius a in parametric form as:

$$\begin{cases} x = p + a \cos \theta \\ y = q + a \sin \theta \end{cases}$$

Again the reader should confirm that using the trigonometric identity

$$\sin^2 \theta + \cos^2 \theta = 1$$

gives the appropriate cartesian equation.

Remember: If we expand $(x-p)^2 + (y-q)^2 = a^2$ we obtain:
 $x^2 - 2px + p^2 + y^2 - 2qy + q^2 = a^2$
 i.e. $x^2 + y^2 - 2px - 2qy = a^2 - p^2 - q^2$
 i.e. $x^2 + y^2 - 2px - 2qy = (\text{a constant})$

In this expanded form the cartesian equation of a circle is characterised by:

- the coefficient of x^2 being the same as the coefficient of y^2 ,
- the only terms being those in x^2, y^2, x, y and a constant (and of these any two of the last three could be zero).

EXAMPLE 10

- a** Find the vector equation of the circle centre $(0, 0)$ and radius 5 units.
b For each of the points A, B and C given below determine whether they lie inside, on or outside the circle centre $(0, 0)$ and radius 5 units.
 Point A, position vector $3\mathbf{i} - 4\mathbf{j}$. Point B, position vector $2\mathbf{i} + 3\mathbf{j}$. Point C, position vector $4\mathbf{i} - 7\mathbf{j}$.

Solution

a The circle centre $(0, 0)$ and radius a units has vector equation $|\mathbf{r}| = a$.
 Thus the circle centre $(0, 0)$ and radius 5 units has vector equation $|\mathbf{r}| = 5$.

b To lie *on* the circle, \mathbf{r} must be such that $|\mathbf{r}| = 5$.
 To lie *inside* the circle, \mathbf{r} must be such that $|\mathbf{r}| < 5$.
 To lie *outside* the circle, \mathbf{r} must be such that $|\mathbf{r}| > 5$.

For point A $|\mathbf{r}| = |3\mathbf{i} - 4\mathbf{j}| = 5$. Thus A lies on the circle.

For point B $|\mathbf{r}| = |2\mathbf{i} + 3\mathbf{j}| = \sqrt{13}$. Thus B lies inside the circle.

For point C $|\mathbf{r}| = |4\mathbf{i} - 7\mathbf{j}| = \sqrt{65}$. Thus C lies outside the circle.

EXAMPLE 11

Find the vector equation of the circle centre C, position vector $2\mathbf{i} + 3\mathbf{j}$, and radius 5 units.
 Determine whether the point A, position vector $5\mathbf{i} - \mathbf{j}$, lies inside, on or outside the circle.

Solution

The vector equation of a circle of radius a and with its centre at the point with position vector \mathbf{d} is:

$$|\mathbf{r} - \mathbf{d}| = a.$$

Thus the vector equation of a circle of radius 5 and with its centre at the point with position vector $2\mathbf{i} + 3\mathbf{j}$ is:

For point A $|\mathbf{r} - (2\mathbf{i} + 3\mathbf{j})| = |(5\mathbf{i} - \mathbf{j}) - (2\mathbf{i} + 3\mathbf{j})| = |3\mathbf{i} - 4\mathbf{j}| = 5$ Point A lies on the circle.



EXAMPLE 12

(As in the *Preliminary work*, but now with mention of the vector equation.)

Find the centre, radius and vector equation of the circle with cartesian equation

$$x^2 + y^2 + 6y = 10x.$$

Solution

Given $x^2 + y^2 + 6y = 10x$

i.e. $x^2 - 10x + y^2 + 6y = 0$

Create gaps: $x^2 - 10x + y^2 + 6y = 0$

Complete the squares: $x^2 - 10x + 25 + y^2 + 6y + 9 = 0 + 25 + 9$

Hence $(x - 5)^2 + (y + 3)^2 = 34$

The given circle has its centre at $(5, -3)$ and a radius of $\sqrt{34}$ units.

The vector equation of the circle is $|\mathbf{r} - (5\mathbf{i} - 3\mathbf{j})| = \sqrt{34}$.

EXAMPLE 13

Find the position vectors of the points where the straight line $\mathbf{r} = \begin{pmatrix} -6 \\ 2 \end{pmatrix} + \lambda \begin{pmatrix} 1 \\ 2 \end{pmatrix}$ meets the circle

$$\left| \mathbf{r} - \begin{pmatrix} 2 \\ 3 \end{pmatrix} \right| = 5\sqrt{2}.$$

Solution

If point A, position vector \mathbf{r}_A , lies on both the line and the circle then

$$\mathbf{r}_A = \begin{pmatrix} -6 \\ 2 \end{pmatrix} + \lambda \begin{pmatrix} 1 \\ 2 \end{pmatrix} \quad \text{and} \quad \left| \mathbf{r} - \begin{pmatrix} 2 \\ 3 \end{pmatrix} \right| = 5\sqrt{2}.$$

Substituting the first expression into the second gives:

$$\left| \begin{pmatrix} -6 \\ 2 \end{pmatrix} + \lambda \begin{pmatrix} 1 \\ 2 \end{pmatrix} - \begin{pmatrix} 2 \\ 3 \end{pmatrix} \right| = 5\sqrt{2}.$$

$$\left| \begin{pmatrix} \lambda - 8 \\ 2\lambda - 1 \end{pmatrix} \right| = 5\sqrt{2}.$$

Thus $(\lambda - 8)^2 + (2\lambda - 1)^2 = 50$

Solving: $\lambda = 1$ or $\lambda = 3$.

If $\lambda = 1$, $\mathbf{r}_A = \begin{pmatrix} -5 \\ 4 \end{pmatrix}$

If $\lambda = 3$, $\mathbf{r}_A = \begin{pmatrix} -3 \\ 8 \end{pmatrix}$

solve $((\lambda - 8)^2 + (2\lambda - 1)^2 = 50, \lambda)$
 $\{\lambda = 1, \lambda = 3\}$

These are the position vectors of the two points common to the line and circle, i.e. the points where the line meets the circle.



Exercise 4E

1 Find the cartesian equations for each of the following parametric equations.

a
$$\begin{cases} x = 4 + t \\ y = 2t \end{cases}$$

b
$$\begin{cases} x = t \\ y = \frac{1}{t} \end{cases}$$

c
$$\begin{cases} x = t^2 \\ y = 2t \end{cases}$$

d
$$\begin{cases} x = \sqrt{t-1} \\ y = t^2 \end{cases}$$

2 Find the cartesian equations for each of the following vector equations.

a $\mathbf{r} = (3 - t)\mathbf{i} + (4 + 2t)\mathbf{j}$

b $\mathbf{r} = (t - 1)\mathbf{i} + \frac{1}{t}\mathbf{j}$

c $\mathbf{r} = (t - 1)\mathbf{i} + (t^2 + 4)\mathbf{j}$

d $\mathbf{r} = (2 + \cos\theta)\mathbf{i} + (1 + 2\sin\theta)\mathbf{j}$

3 Vector equations of the form $\mathbf{r} = (a \cos \theta)\mathbf{i} + (b \sin \theta)\mathbf{j}$ define **ellipses**.

Determine the parametric equations and the cartesian equation of the ellipse with vector equation $\mathbf{r} = (2 \cos \theta)\mathbf{i} + (3 \sin \theta)\mathbf{j}$.

Use a graphic calculator capable of displaying the graphs of functions defined parametrically to view the ellipse.

4 Vector equations of the form $\mathbf{r} = (a \sec \theta)\mathbf{i} + (b \tan \theta)\mathbf{j}$ define **hyperbolas**.

Determine the parametric equations and the cartesian equation of the hyperbola with vector equation $\mathbf{r} = (-3 \sec \theta)\mathbf{i} + (2 \tan \theta)\mathbf{j}$.

Use a graphic calculator capable of displaying the graphs of functions defined parametrically to view the hyperbola.

5 Considering only the x - y plane, which of the following equations represent circles?

A: $\mathbf{r} = 2\mathbf{i}$

B: $|\mathbf{r}| = 6$

C: $\mathbf{r} = 6\mathbf{i} + 3\mathbf{j}$

D: $|\mathbf{r} - (5\mathbf{i} - 4\mathbf{j})| = 24$

E: $x^2 + y^2 + 4x - 8y = 5$

F: $x^2 + 8xy + y^2 + 6y = 34$

6 **a** Find the vector equation of the circle with centre $(0, 0)$ and radius 25 units.

b For each of the points A to D given below, determine whether the point lies inside, on, or outside the circle.

Point A, position vector $19\mathbf{i} - 18\mathbf{j}$.

Point B, position vector $-20\mathbf{i} + 15\mathbf{j}$.

Point C, position vector $14\mathbf{i} + 17\mathbf{j}$.

Point D, position vector $-24\mathbf{i} - 7\mathbf{j}$.

7 Find the cartesian equation of a circle with vector equation $|\mathbf{r}| = 65$.

If each of the following points lie on this circle determine a and b given that a is positive and b is negative.

Point A $(-52, a)$.

Point B $(b, 25)$.

8 Find the vector equation of the circle centre C, position vector $-7\mathbf{i} + 4\mathbf{j}$, and radius $4\sqrt{5}$ units. Determine whether the point A, position vector $\mathbf{i} + 8\mathbf{j}$, lies inside, on or outside the circle.

- 9** Find the vector equation of each of the following circles.
- a** Centre $(1, -5)$ and radius 9. **b** Centre $(-3, 4)$ and radius 10.
c Centre $(-12, 3)$ and radius $2\sqrt{3}$. **d** Centre $(-13, -2)$ and radius 4.

- 10** Find the cartesian equation of each of the following circles, giving your answers in the form $x^2 + y^2 + dx + ey = c$.

- a** Centre has position vector $2\mathbf{i} + 3\mathbf{j}$. Radius 5.
b Centre has position vector $-4\mathbf{i} + 2\mathbf{j}$. Radius $\sqrt{7}$.
c Centre has position vector $4\mathbf{i} - 3\mathbf{j}$. Radius 7.

- 11** Find the radius and position vector of the centre of each of the following circles.

- a** $|\mathbf{r} - (6\mathbf{i} + 3\mathbf{j})| = 5$ **b** $|\mathbf{r} - 2\mathbf{i} + 3\mathbf{j}| = 6$
c $|(x - 3)\mathbf{i} + (y + 4)\mathbf{j}| = 3$ **d** $|\mathbf{r}| = 20$
e $16x^2 + 16y^2 = 25$ **f** $(x - 2)^2 + (y + 3)^2 = 49$
g $x^2 + y^2 - 6x - 18y + 65 = 0$ **h** $x^2 + y^2 + 20x - 2y = 20$

- 12** Find the distance between the centres of the two circles given below:

$$|\mathbf{r} - (\mathbf{i} - \mathbf{j})| = 6 \quad \text{and} \quad |\mathbf{r} - 6\mathbf{i} - 11\mathbf{j}| = 7.$$

- 13** The circle $|\mathbf{r} - (2\mathbf{i} - 5\mathbf{j})| = 5$ has centre A and the circle $|\mathbf{r} - (5\mathbf{i} + 2\mathbf{j})| = 3$ has centre B. Find the vector equation of the straight line through A and B.

- 14** Point A is the centre of the circle $|\mathbf{r} - (3\mathbf{i} - 2\mathbf{j})| = 3$ and point B is the centre of the circle $|\mathbf{r} - (9\mathbf{i} + 6\mathbf{j})| = 7$. Find $|\overrightarrow{AB}|$.

Determine whether the circles have two points in common, just one point in common or no points in common and justify your answer.

- 15** Point A is the centre of the circle $|\mathbf{r} - (3\mathbf{i} - \mathbf{j})| = 3$ and point B is the centre of the circle $|\mathbf{r} - (13\mathbf{i} + \mathbf{j})| = 7$. Find $|\overrightarrow{AB}|$.

Determine whether the circles have two points in common, just one point in common or no points in common and justify your answer.

- 16** Find the position vectors of the points where the straight line $\mathbf{r} = \begin{pmatrix} -10 \\ 15 \end{pmatrix} + \lambda \begin{pmatrix} 7 \\ -3 \end{pmatrix}$ meets the circle $\left| \mathbf{r} - \begin{pmatrix} -1 \\ 7 \end{pmatrix} \right| = \sqrt{29}$.

- 17** $\mathbf{r} = 10\mathbf{i} - 9\mathbf{j} + \lambda(4\mathbf{i} - 5\mathbf{j})$ is a tangent to the circle $|\mathbf{r} + 7\mathbf{i} - 2\mathbf{j}| = \sqrt{41}$. Find the position vector of the point of contact.

Closest approach

If two moving particles, each following straight line paths, are not on 'collision course' there will be a moment in time during the motion when they are closer to each other than at any other time (unless they are both travelling at the same velocity and thus constantly maintain the same distance apart).

The distance of closest approach can be determined in a number of ways, as the next example shows.

(If the closest approach occurs for $t \leq 0$, then for $t > 0$, the particles are moving further apart.)

EXAMPLE 14

Suppose that at time $t = 0$ two particles, A and B have the following position vectors (\mathbf{r} metres) and velocity vectors (\mathbf{v} metres/second):

$$\begin{aligned} \mathbf{r}_A &= 10\mathbf{i} + 30\mathbf{j} & \mathbf{v}_A &= 5\mathbf{i} + 9\mathbf{j} \\ \mathbf{r}_B &= 40\mathbf{i} + 40\mathbf{j} & \mathbf{v}_B &= -7\mathbf{i} \end{aligned}$$

If the particles continue with these velocities what will be the minimum distance they are apart in the subsequent motion?

Solution

Solution using calculus (or by viewing graph)

$$\begin{aligned} \text{At time } t, t > 0, \quad \mathbf{r}_A &= 10\mathbf{i} + 30\mathbf{j} + t(5\mathbf{i} + 9\mathbf{j}) \\ &= (10 + 5t)\mathbf{i} + (30 + 9t)\mathbf{j} \\ \text{and} \quad \mathbf{r}_B &= 40\mathbf{i} + 40\mathbf{j} + t(-7\mathbf{i}) \\ &= (40 - 7t)\mathbf{i} + 40\mathbf{j} \end{aligned}$$

The 'separation vector' from B to A at time t will be:

$$\mathbf{r}_A - \mathbf{r}_B = (-30 + 12t)\mathbf{i} + (-10 + 9t)\mathbf{j}$$

If $|\mathbf{r}_A - \mathbf{r}_B| = d$, $d \geq 0$, then we require d to be a minimum.

$$\begin{aligned} \text{But} \quad d^2 &= (-30 + 12t)^2 + (-10 + 9t)^2 \\ &= 225t^2 - 900t + 1000 \end{aligned}$$

Viewing the graph of the quadratic function

$$y = 225x^2 - 900x + 1000$$

on a calculator, or using calculus techniques, we can determine that the minimum value of y , i.e. d^2 , occurs when x , i.e. t , is equal to 2. With $d \geq 0$ this will also be when d is minimised.

For this value of t we have $d_{\min} = 10$.

The least distance between the particles in the subsequent motion is 10 metres (and occurs when $t = 2$).

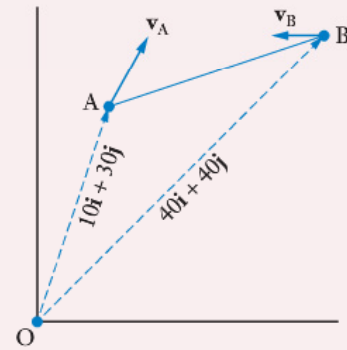

Solution using relative velocities and trigonometry

From the diagram on the right

$$\begin{aligned}\vec{AB} &= -(10\mathbf{i} + 30\mathbf{j}) + (40\mathbf{i} + 40\mathbf{j}) \\ &= 30\mathbf{i} + 10\mathbf{j}\end{aligned}$$

If we subtract \mathbf{v}_B from the velocity of each particle we view the situation as seen by an observer on particle B.

$$\begin{aligned}{}^A\mathbf{v}_B &= \mathbf{v}_A - \mathbf{v}_B \\ &= (5\mathbf{i} + 9\mathbf{j}) - (-7\mathbf{i}) \\ &= 12\mathbf{i} + 9\mathbf{j}\end{aligned}$$

Showing this information in the second diagram we see that the minimum distance between A and B in the subsequent motion is given by CB.

$$\text{Now } \sin(\phi - \theta) = \frac{CB}{AB}$$

$$\begin{aligned}\therefore CB &= AB \sin(\phi - \theta) \\ &= \sqrt{30^2 + 10^2} \sin(\phi - \theta)\end{aligned}$$

$$\text{But } \tan \theta = \frac{10}{30} \quad \text{and} \quad \tan \phi = \frac{9}{12}$$

By determining θ and ϕ and hence $(\phi - \theta)$ we obtain $CB = 10$ km.

The least distance between the particles in the subsequent motion is 10 metres.

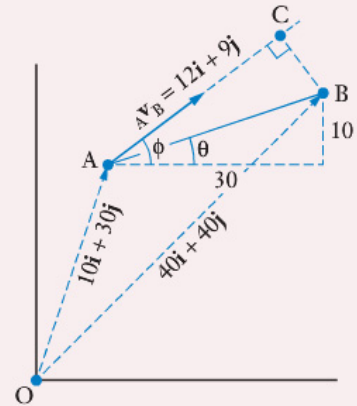
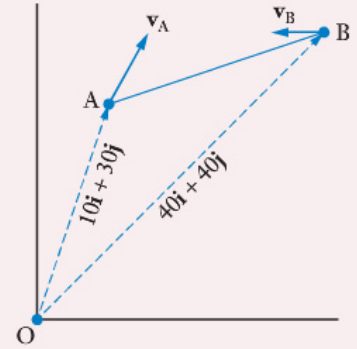

Solution using relative velocity and scalar product

Consider triangle ABC from the previous diagram.

Suppose the closest approach occurs at time t , $t > 0$.

$$\begin{aligned}\vec{CB} &= \vec{CA} + \vec{AB} \\ &= -[t(12\mathbf{i} + 9\mathbf{j})] + 30\mathbf{i} + 10\mathbf{j} \\ &= (30 - 12t)\mathbf{i} + (10 - 9t)\mathbf{j}\end{aligned}$$

$$\begin{aligned}\vec{CB} \text{ is perpendicular to } 12\mathbf{i} + 9\mathbf{j}. \quad & \text{Thus } (12\mathbf{i} + 9\mathbf{j}) \cdot [(30 - 12t)\mathbf{i} + (10 - 9t)\mathbf{j}] = 0 \\ \therefore & 12(30 - 12t) + 9(10 - 9t) = 0 \\ \text{giving} & \quad t = 2\end{aligned}$$

When $t = 2$, $\vec{CB} = 6\mathbf{i} - 8\mathbf{j}$ and so $|\vec{CB}| = 10$.

The least distance between the particles in the subsequent motion is 10 metres (and occurs when $t = 2$).

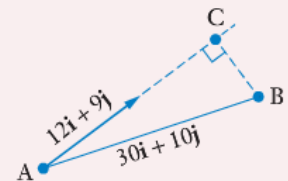

Distance from a point to a line

EXAMPLE 15

Find the perpendicular distance from the point A, position vector $34\mathbf{i} + 12\mathbf{j}$, to the line L, vector equation $\mathbf{r} = 10\mathbf{i} + 14\mathbf{j} + \lambda(5\mathbf{i} + 2\mathbf{j})$.

Solution

Suppose that the perpendicular from A to the line L meets the line at P.
Suppose also that at P the value of λ is λ_1 .

$$\text{Then } \vec{OP} = 10\mathbf{i} + 14\mathbf{j} + \lambda_1(5\mathbf{i} + 2\mathbf{j})$$

$$\begin{aligned} \text{Now } \vec{AP} &= \vec{AO} + \vec{OP} \\ &= -(34\mathbf{i} + 12\mathbf{j}) + 10\mathbf{i} + 14\mathbf{j} + \lambda_1(5\mathbf{i} + 2\mathbf{j}) \\ &= (5\lambda_1 - 24)\mathbf{i} + (2\lambda_1 + 2)\mathbf{j} \end{aligned}$$

$$\text{Line L is parallel to } 5\mathbf{i} + 2\mathbf{j} \text{ and so } (5\mathbf{i} + 2\mathbf{j}) \cdot \vec{AP} = 0$$

$$\therefore 5(5\lambda_1 - 24) + 2(2\lambda_1 + 2) = 0$$

$$\text{giving } \lambda_1 = 4$$

$$\text{Hence } \vec{AP} = -4\mathbf{i} + 10\mathbf{j} \text{ and so } |\vec{AP}| = 2\sqrt{29}.$$

The perpendicular distance from the point A to the line L is $2\sqrt{29}$ units.

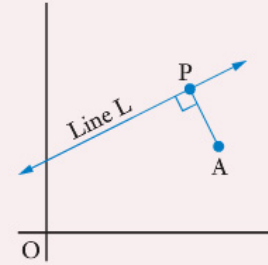

Exercise 4F

- 1 The sketch on the right shows a ship travelling with constant velocity $(10\mathbf{i} + 5\mathbf{j})$ km/h.

The path of the ship will take it past a fixed offshore drilling platform P.

At 8 a.m. the situation is as shown in the sketch with the platform having a position vector of $(25\mathbf{i} + 15\mathbf{j})$ relative to the ship. How close does the ship come to the drilling platform and when does this closest approach occur?

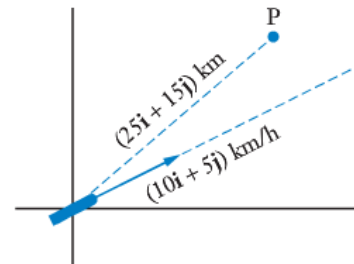

- 2 At time $t = 0$ seconds particles A and B are moving with velocities $\begin{pmatrix} -10 \\ -2 \end{pmatrix}$ m/s and $\begin{pmatrix} -2 \\ -6 \end{pmatrix}$ m/s respectively, the position vector of B relative to A being $\begin{pmatrix} -16 \\ 13 \end{pmatrix}$ m.

Assuming A and B maintain these velocities find the least distance of separation between the particles in the subsequent motion and the value of t for which it occurs.

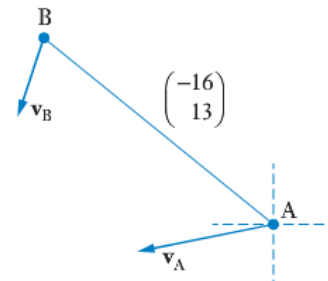

- 3** With respect to the location of a mouse, a snake lies in wait at $(5\mathbf{i} + 6\mathbf{j})$ m. The mouse moves in a direction parallel to the vector $\mathbf{i} + 2\mathbf{j}$. The snake, being vectorially astute (!), makes its move when the mouse is at the point on its path that is closest to the snake. If this closest distance is x m then:
- If $x \leq 1$ the snake is certain to catch the mouse.
 If $1 < x < 2$ the snake is more likely to catch the mouse than miss it.
 If $x \geq 2$ the mouse is more likely to escape.
- Calculate the value of x and state what is likely to happen.

- 4** Particles A and B have constant velocities of $(3\mathbf{i} + 4\mathbf{j})$ cm/s and $-3\mathbf{i}$ cm/s respectively. When $t = 0$ seconds B's position relative to A is $(40\mathbf{i} + 5\mathbf{j})$ cm. Find the least distance between the particles during the subsequent motion and the value of t for which it occurs.

- 5** At 3 a.m. one day the position vectors (\mathbf{r} km) and velocity vectors (\mathbf{v} km/h) of two ships A and B are as follows:

$$\begin{aligned} \mathbf{r}_A &= \begin{pmatrix} 30 \\ 10 \end{pmatrix} & \mathbf{v}_A &= \begin{pmatrix} 10 \\ -5 \end{pmatrix} \\ \mathbf{r}_B &= \begin{pmatrix} 54 \\ -19 \end{pmatrix} & \mathbf{v}_B &= \begin{pmatrix} -8 \\ 7 \end{pmatrix} \end{aligned}$$

If the ships continue with these velocities what will be the minimum distance they are apart in the subsequent motion?

- 6** At time $t = 0$ seconds the position vectors (\mathbf{r} m) and velocity vectors (\mathbf{v} m/s) of two particles A and B are as given below:

$$\begin{aligned} \mathbf{r}_A &= 20\mathbf{i} - 10\mathbf{j} & \mathbf{v}_A &= 4\mathbf{i} + 5\mathbf{j} \\ \mathbf{r}_B &= 16\mathbf{i} + 23\mathbf{j} & \mathbf{v}_B &= 6\mathbf{i} - 3\mathbf{j} \end{aligned}$$

If the particles continue with these velocities what will be the minimum distance they are apart in the subsequent motion?

- 7** Find the perpendicular distance from the point A, position vector $14\mathbf{i} - 3\mathbf{j}$, to the line L, vector equation $\mathbf{r} = -5\mathbf{i} + 22\mathbf{j} + \lambda(5\mathbf{i} - 2\mathbf{j})$.

- 8** Find the perpendicular distance from the point A, position vector $\begin{pmatrix} 11 \\ 18 \end{pmatrix}$, to the line L, vector equation $\mathbf{r} = \begin{pmatrix} 3 \\ -1 \end{pmatrix} + \lambda \begin{pmatrix} 3 \\ 4 \end{pmatrix}$.

- 9** Find the perpendicular distance from the point A, position vector $\begin{pmatrix} -3 \\ 8 \end{pmatrix}$, to the line L, vector equation $\mathbf{r} = \begin{pmatrix} -3 \\ 0 \end{pmatrix} + \lambda \begin{pmatrix} 2 \\ -2 \end{pmatrix}$.

Miscellaneous exercise four

This miscellaneous exercise may include questions involving the work of this chapter, the work of any previous chapters, and the ideas mentioned in the Preliminary work section at the beginning of the book.

- 1 Prove that the lines L_1 and L_2 are perpendicular given that

L_1 has equation $\mathbf{r} = 2\mathbf{i} + 7\mathbf{j} + \lambda(10\mathbf{i} + 4\mathbf{j})$

and L_2 has equation $\mathbf{r} = 3\mathbf{i} - 4\mathbf{j} + \mu(-2\mathbf{i} + 5\mathbf{j})$.

- 2 Write the equations of each of the absolute value functions shown below.

a

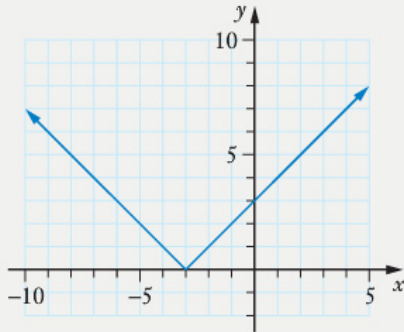

b

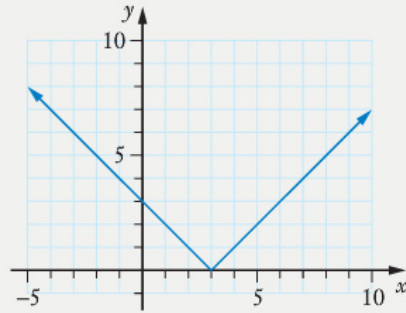

c

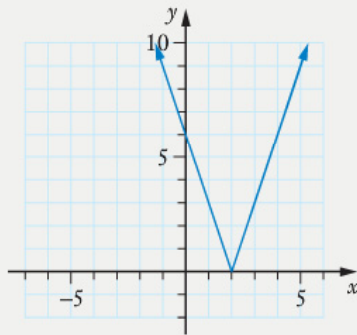

d

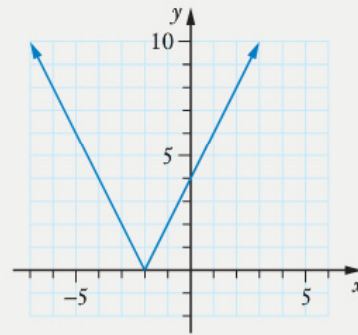

- 3 Find the radius and the cartesian coordinates of the centre of each of the following circles.

a $|\mathbf{r} - (7\mathbf{i} - \mathbf{j})| = 5$

b $|\mathbf{r} - 7\mathbf{i} - \mathbf{j}| = 6$

c $x^2 + y^2 = 18$

d $(x - 1)^2 + (y + 8)^2 = 75$

e $x^2 + y^2 + 2x = 14y + 50$

f $x^2 + 10x + y^2 = 151 + 14y$

- 4 The graph of $y = f(x)$ is shown on the right.

Produce sketch graphs of each of the following:

a $y = -f(x)$

b $y = f(-x)$

c $y = |f(x)|$

d $y = f(|x|)$

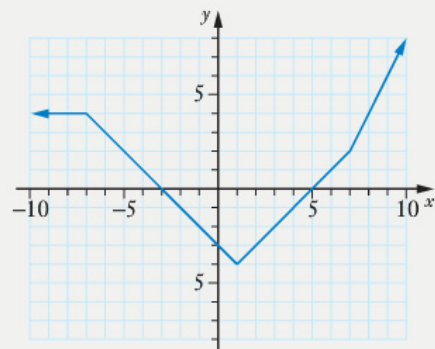

- 5 a** $3x^3 - 11x^2 + 25x - 25 = (ax - b)(x^2 + cx + 5)$ for real integers a , b and c . Determine a , b and c .
- b** Showing full algebraic reasoning, find all values of x , real and complex, for which $3x^3 - 11x^2 + 25x - 25 = 0$.
- c** Check your answers to **b** using a calculator.

6 Given that $f(x) = 1 - \frac{1}{\sqrt{4-x}}$ determine

- a** $f(-21)$, **b** $f[f(3)]$.

Viewing the graph of $f(x)$ on your calculator if you wish, determine

- c** the domain of f , **d** the range of f .
- e** State the domain and range of f^{-1} and find its rule.

7 a Express the complex number $z = 2 \operatorname{cis}\left(\frac{\pi}{6}\right)$ in cartesian form, $a + ib$.

b Express the complex number $w = -1 - \sqrt{3}i$ in polar form, $r \operatorname{cis} \theta$, with $r \geq 0$ and $-\pi < \theta \leq \pi$.

c Express zw in both polar and cartesian form.

d Express $\frac{z}{w}$ in both polar and cartesian form.

8 For each of the following determine whether the given straight line cuts the circle in two places, touches it tangentially or does not touch or cut it at all. For those parts in which the line and the circle do meet give the position vector(s) of the point(s) of contact.

a The line $\mathbf{r} = -10\mathbf{i} + 24\mathbf{j} + \lambda(5\mathbf{i} + \mathbf{j})$ and the circle $|\mathbf{r} - (34\mathbf{i} + 12\mathbf{j})| = 2\sqrt{130}$.

b The line $\mathbf{r} = -\mathbf{i} + 5\mathbf{j} + \lambda(3\mathbf{i} - \mathbf{j})$ and the circle $|\mathbf{r} - (3\mathbf{i} + \mathbf{j})| = \sqrt{5}$.

c The line $\mathbf{r} = -\mathbf{i} + 7\mathbf{j} + \lambda(\mathbf{i} + 3\mathbf{j})$ and the circle $|\mathbf{r} - (4\mathbf{i} + 2\mathbf{j})| = 2\sqrt{10}$.

9 Without simply using de Moivre's theorem, prove that if $\operatorname{cis} \theta = \cos \theta + i \sin \theta$ then

$$\frac{1}{\operatorname{cis} \theta} = \operatorname{cis}(-\theta).$$

10 a If $z = \cos \theta + i \sin \theta$ use de Moivre's theorem to prove that:

$$z^k + \frac{1}{z^k} = 2 \cos(k\theta)$$

b If $k = 1$ then it follows that $z + \frac{1}{z} = 2 \cos \theta$

Use this fact and the result from **a** to prove:

i $\cos^3 \theta = \frac{\cos(3\theta) + 3 \cos \theta}{4}$

ii $\cos^4 \theta = \frac{\cos(4\theta) + 4 \cos(2\theta) + 3}{8}$



5.

Vectors in three dimensions

- Three-dimensional vectors
- The angle between two lines
- Vector product (cross product)
- Vector equation of a line
- Vector equation of a plane
- Given three points that lie in the plane
- Interception/collision
- Vector equation of a sphere
- Distance from a point to a line revisited
- Miscellaneous exercise five

Situation (Challenging)

It was the year 2100 and, as coincidence would have it, that was also the time of day. Space travel was commonplace. The person-made space station located at $(0, 0, 0)$ was the space traffic control point. The locations of other space stations, planets and space vehicles were then given with respect to $(0, 0, 0)$.

Victor Lim was on space traffic control duty on space station $(0, 0, 0)$ and was in radio contact with three Space Buses A, B and C.

Space Bus A was piloted by Captain Hector.

Space Bus B was piloted by Captain Over.

Space Bus C was piloted by Captain Rover.

'What's my vector, Victor? Over.' said Hector.

'You're at $1000\mathbf{i} - 1500\mathbf{j} + 3000\mathbf{k}$, Hector' replied Victor. 'What's your velocity? Over.'

'Do you want it as a vector, Victor? Over.'

'Yes, please. A vector, Hector. Over.' said Victor, wondering how else Captain Hector thought he would give his velocity.

'It's $2500\mathbf{i} + 3000\mathbf{j} - 2000\mathbf{k}$, over.'

No sooner had Victor checked that the voice input device had correctly assimilated and confirmed the data contained in the conversation than the radio again crackled into life. It was Space Bus B and Captain Over.

'Hi Victor, it's Over, over?'

'What's over? Over.' replied Victor.

'Nothing's over, Victor, it's me Captain Over. I'm just confirming my velocity vector, Victor.

It's $-2700\mathbf{i} - 900\mathbf{j} - 1800\mathbf{k}$, can you confirm my position vector, Victor? Over.'

'It's $2200\mathbf{i} + 300\mathbf{j} + 6600\mathbf{k}$, Over. Over.'

'Thank you,' said Over. 'Over.'

'Is that you, Rover? Over.'

'Yes,' said Rover. 'My velocity vector is $3600\mathbf{i} + 1800\mathbf{j} - 450\mathbf{k}$, Victor. What's my position vector? Over.'

'It's $100\mathbf{i} - 600\mathbf{j} + 6150\mathbf{k}$. Over.'

'Thanks Victor. Over.'

Questions

Assume that all of the above vectors describe the situation at 2100 hours.

Assume also that distances are in kilometres and velocities in km/h.

- 1 How far was Hector from Victor at 2100 hours?
- 2 How far was Hector from Over at 2100 hours?
- 3 What was Rover's speed at 2100 hours?
- 4 On what vector from Hector is Rover at 2100 hours?
- 5 Show that unless Over and/or Rover change course they will collide and find the time this would occur and the position vector of the location.
- 6 What is the closest distance Hector comes to Victor and when does this closest distance occur? (Give distance to the nearest kilometre and time to the nearest minute.)
- 7 When is Hector closest to Over? (Answer to the nearest minute and assume it was **not** Over that changed course to avoid collision with Rover.)

Three-dimensional vectors

The previous situation rather ‘threw you in the deep end’ with regard to vectors in three dimensions. However the techniques involved are the same as we used for similar situations involving two dimensions, we simply extend these ideas to involve the third dimension. Well done if you managed the situation but do not be too worried if you found it challenging, as it was not an easy situation.

Whether you managed the previous situation or not, read through the following examples as they show how the two-dimensional vector ideas you are already familiar with can be extended to three dimensions. Note especially examples 2 and 4 which use the column matrix form of representing a vector.

In this form of representation the vector $a\mathbf{i} + b\mathbf{j} + c\mathbf{k}$ is written $\begin{pmatrix} a \\ b \\ c \end{pmatrix}$.

You may find this column matrix a particularly useful form of representation when three dimensions are involved.

EXAMPLE 1

If $\mathbf{a} = 14\mathbf{i} - 5\mathbf{j} + 2\mathbf{k}$ and $\mathbf{b} = \mathbf{i} + 2\mathbf{j} + 3\mathbf{k}$ find

- a** $\mathbf{a} + \mathbf{b}$ **b** $2\mathbf{a} - \mathbf{b}$ **c** $|\mathbf{a}|$ **d** a unit vector parallel to \mathbf{a} .

Solution

$$\begin{aligned} \mathbf{a} \quad \mathbf{a} + \mathbf{b} &= (14\mathbf{i} - 5\mathbf{j} + 2\mathbf{k}) + (\mathbf{i} + 2\mathbf{j} + 3\mathbf{k}) \\ &= 15\mathbf{i} - 3\mathbf{j} + 5\mathbf{k} \end{aligned}$$

$$\begin{aligned} \mathbf{b} \quad 2\mathbf{a} - \mathbf{b} &= 2(14\mathbf{i} - 5\mathbf{j} + 2\mathbf{k}) - (\mathbf{i} + 2\mathbf{j} + 3\mathbf{k}) \\ &= (28\mathbf{i} - 10\mathbf{j} + 4\mathbf{k}) - (\mathbf{i} + 2\mathbf{j} + 3\mathbf{k}) \\ &= 27\mathbf{i} - 12\mathbf{j} + \mathbf{k} \end{aligned}$$

$$\begin{aligned} \mathbf{c} \quad |\mathbf{a}| &= |14\mathbf{i} - 5\mathbf{j} + 2\mathbf{k}| \\ &= \sqrt{(14)^2 + (-5)^2 + (2)^2} \\ &= 15 \end{aligned}$$

$$\mathbf{d} \quad \text{A unit vector parallel to } \mathbf{a} \text{ is } \frac{1}{15}(14\mathbf{i} - 5\mathbf{j} + 2\mathbf{k}).$$

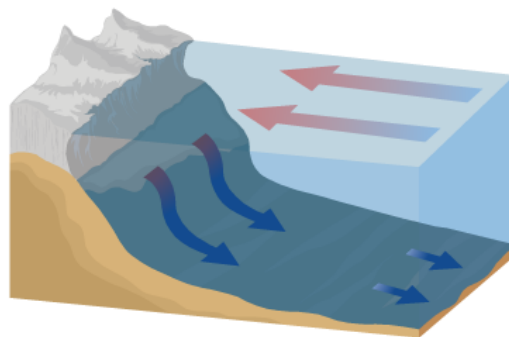

iStock.com/mopichai

EXAMPLE 2

Point A has position vector $\begin{pmatrix} 1 \\ 5 \\ 4 \end{pmatrix}$ and point B has position vector $\begin{pmatrix} 6 \\ 5 \\ -6 \end{pmatrix}$.

Find the position vector of the point P that divides AB internally in the ratio 2 : 3.

Solution

If P divides AB in the ratio 2 : 3 then $\overrightarrow{AP} : \overrightarrow{PB} = 2 : 3$, as shown in the diagram on the right.

$$\begin{aligned} \overrightarrow{OP} &= \overrightarrow{OA} + \overrightarrow{AP} \\ &= \overrightarrow{OA} + \frac{2}{5} \overrightarrow{AB} \end{aligned}$$

$$\text{But } \overrightarrow{OA} = \begin{pmatrix} 1 \\ 5 \\ 4 \end{pmatrix} \quad \text{and} \quad \overrightarrow{AB} = -\begin{pmatrix} 1 \\ 5 \\ 4 \end{pmatrix} + \begin{pmatrix} 6 \\ 5 \\ -6 \end{pmatrix} = \begin{pmatrix} 5 \\ 0 \\ -10 \end{pmatrix}$$

$$\therefore \overrightarrow{OP} = \begin{pmatrix} 1 \\ 5 \\ 4 \end{pmatrix} + \frac{2}{5} \begin{pmatrix} 5 \\ 0 \\ -10 \end{pmatrix} = \begin{pmatrix} 3 \\ 5 \\ 0 \end{pmatrix}$$

The point that divides AB internally in the ratio 2 : 3 has position vector $\begin{pmatrix} 3 \\ 5 \\ 0 \end{pmatrix}$.

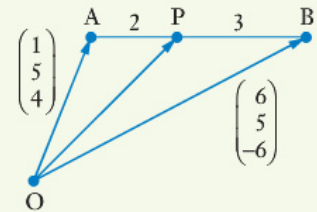

The angle between two lines

In two dimensions two lines that are not parallel must cut each other somewhere. This is not the case in three dimensions where two non-parallel lines may be such that they have no point in common. This is the case with the lines EA and BC in the square based pyramid ABCDE shown on the right. EA and BC do not intersect. They are said to be **skew lines**. Skew lines do not intersect and are not parallel.

We can still refer to the angle between skew lines but in this case we mean the angle between one of the skew lines and another line drawn parallel to the second skew line and intersecting the first.

Thus the angle between the skew lines EA and BC would be $\angle EAD$ because AD is parallel to BC and does meet EA.

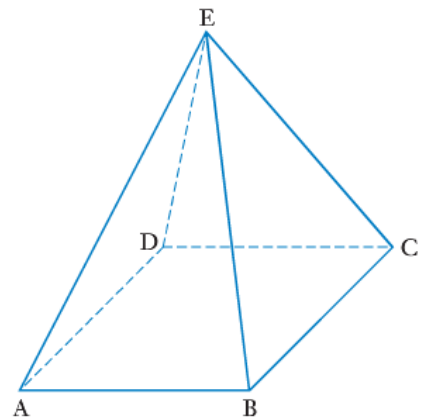

EXAMPLE 3

The diagram shows a rectangular prism ABCDEFGH.

AB = 6 cm, BC = 4 cm and CG = 3 cm.

Use vector techniques to find, in degrees and correct to one decimal place:

- $\angle FDB$,
- the acute angle between the skew lines DB and HE.

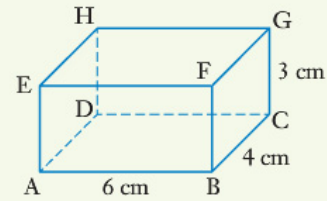

Solution

- Consider x , y and z -axes as shown on the right.

$$\text{Then } \vec{DF} = 6\mathbf{i} + 3\mathbf{j} + 4\mathbf{k}$$

$$\text{and } \vec{DB} = 6\mathbf{i} + 4\mathbf{k}$$

$$\therefore \vec{DF} \cdot \vec{DB} = (6)(6) + (3)(0) + (4)(4) = 52$$

$$\therefore 52 = \sqrt{6^2 + 3^2 + 4^2} \sqrt{6^2 + 0^2 + 4^2} \cos \angle FDB$$

giving $\angle FDB \approx 22.6^\circ$

- $\vec{DB} \cdot \vec{HE} = (6\mathbf{i} + 4\mathbf{k}) \cdot (4\mathbf{k}) = 16$

$$\therefore 16 = \sqrt{6^2 + 4^2} (4) \cos \theta \text{ where } \theta \text{ is the required angle.}$$

$$\therefore \theta \approx 56.3^\circ$$

The acute angle between the skew lines DB and HE is approximately 56.3° .

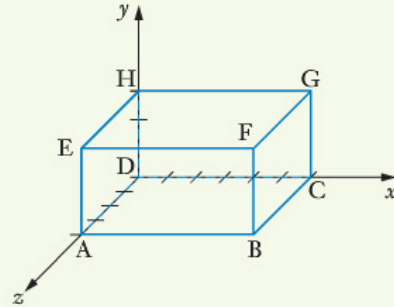

EXAMPLE 4

If $\mathbf{a} = 2\mathbf{i} + \mathbf{j} - \mathbf{k}$, $\mathbf{b} = 3\mathbf{i} - 2\mathbf{j} + 4\mathbf{k}$, $\mathbf{c} = \mathbf{i} - 2\mathbf{j} + \mathbf{k}$ and $\mathbf{d} = 9\mathbf{i} + 5\mathbf{j} + 2\mathbf{k}$ express \mathbf{d} in the form $\lambda\mathbf{a} + \mu\mathbf{b} + \eta\mathbf{c}$.

Solution

$$\begin{pmatrix} 9 \\ 5 \\ 2 \end{pmatrix} = \lambda \begin{pmatrix} 2 \\ 1 \\ -1 \end{pmatrix} + \mu \begin{pmatrix} 3 \\ -2 \\ 4 \end{pmatrix} + \eta \begin{pmatrix} 1 \\ -2 \\ 1 \end{pmatrix}$$

$$\text{Hence } 9 = 2\lambda + 3\mu + \eta$$

$$5 = \lambda - 2\mu - 2\eta$$

$$2 = -\lambda + 4\mu + \eta$$

Solving simultaneously, with the assistance of a calculator, gives

$$\lambda = 3, \mu = 2 \text{ and } \eta = -3.$$

$$\text{Thus } \mathbf{d} = 3\mathbf{a} + 2\mathbf{b} - 3\mathbf{c}.$$

$$\begin{cases} 9 = 2\lambda + 3\mu + \eta \\ 5 = \lambda - 2\mu - 2\eta \\ 2 = -\lambda + 4\mu + \eta \end{cases} \lambda, \mu, \eta$$

$$\{\lambda = 3, \mu = 2, \eta = -3\}$$

Note: Chapter Six, *Systems of linear equations*, will consider the solution of three equations in three unknowns in more detail. For now, use your calculator to solve the equations simultaneously.

Exercise 5A

1 Copy each of the following and indicate on your drawing the direction of the positive z -axis.

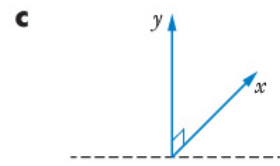
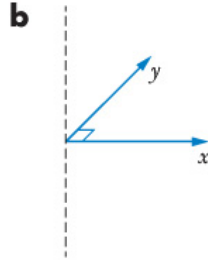
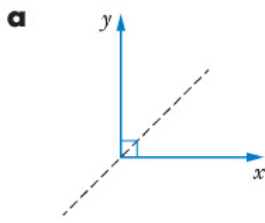

2 If $\mathbf{a} = 2\mathbf{i} + 6\mathbf{j} + 3\mathbf{k}$ and $\mathbf{b} = 3\mathbf{i} + 8\mathbf{j} - \mathbf{k}$ find

a $\mathbf{a} + \mathbf{b}$

b $\mathbf{a} - \mathbf{b}$

c $2\mathbf{a} + \mathbf{b}$

d $2(\mathbf{a} + \mathbf{b})$

e $\mathbf{a} \cdot \mathbf{b}$

f $\mathbf{b} \cdot \mathbf{a}$

g $|\mathbf{a}|$

h $|\mathbf{a} + \mathbf{b}|$

3 If $\mathbf{c} = \begin{pmatrix} -1 \\ 4 \\ 3 \end{pmatrix}$ and $\mathbf{d} = \begin{pmatrix} 2 \\ 0 \\ 4 \end{pmatrix}$ find

a $\mathbf{c} + \mathbf{d}$

b $\mathbf{c} - \mathbf{d}$

c $2\mathbf{c} + \mathbf{d}$

d $2(\mathbf{c} + \mathbf{d})$

e $\mathbf{c} \cdot \mathbf{d}$

f $\mathbf{d} \cdot \mathbf{c}$

g $|\mathbf{c}|$

h $|\mathbf{c} + \mathbf{d}|$

4 If $\mathbf{e} = \langle 1, 4, -3 \rangle$ and $\mathbf{f} = \langle -1, 2, 0 \rangle$ find

a $\mathbf{e} - \mathbf{f}$

b $\mathbf{e} - 2\mathbf{f}$

c $2\mathbf{e} + \mathbf{f}$

d $\mathbf{e} + \mathbf{f}$

e $\mathbf{e} \cdot \mathbf{f}$

f $(2\mathbf{e}) \cdot (3\mathbf{f})$

g $(\mathbf{e} - \mathbf{f}) \cdot (\mathbf{e} - \mathbf{f})$

h $|\mathbf{e} - \mathbf{f}|$

5 A, B and C have position vectors $2\mathbf{i} + 3\mathbf{j} - 4\mathbf{k}$, $3\mathbf{i} + 2\mathbf{j} + \mathbf{k}$ and $-5\mathbf{i} - \mathbf{j} + \mathbf{k}$ respectively.

Express the following in the form $a\mathbf{i} + b\mathbf{j} + c\mathbf{k}$.

a \overrightarrow{AB}

b \overrightarrow{BC}

c \overrightarrow{CA}

d \overrightarrow{AC}

6 If $\mathbf{p} = \begin{pmatrix} 3 \\ 2 \\ 1 \end{pmatrix}$, $\mathbf{q} = \begin{pmatrix} 4 \\ -1 \\ 3 \end{pmatrix}$, $\mathbf{r} = \begin{pmatrix} 2 \\ 0 \\ 1 \end{pmatrix}$ and $\mathbf{s} = \begin{pmatrix} 4 \\ 1 \\ 3 \end{pmatrix}$ find

a $\mathbf{p} + \mathbf{q}$

b $\mathbf{q} + \mathbf{r}$

c $(\mathbf{p} + \mathbf{q}) \cdot (\mathbf{q} + \mathbf{r})$

7 If $\mathbf{u} = 3\mathbf{i} - 2\mathbf{j} + 6\mathbf{k}$ and $\mathbf{v} = 2\mathbf{i} + 14\mathbf{j} + 5\mathbf{k}$ find

a $|\mathbf{u}|$

b $|\mathbf{v}|$

c $\mathbf{u} \cdot \mathbf{v}$

d the angle between \mathbf{u} and \mathbf{v} .

8 Points A and B have position vectors $\mathbf{i} + \mathbf{j} - \mathbf{k}$ and $2\mathbf{i} - \mathbf{j} + 2\mathbf{k}$ respectively, with respect to an origin O. Find the size of $\angle AOB$ correct to the nearest degree.

9 Find the angle between $\mathbf{p} = -\mathbf{i} + 2\mathbf{j} + \mathbf{k}$ and $\mathbf{q} = -\mathbf{i} + \mathbf{j} - 2\mathbf{k}$, giving your answer correct to the nearest degree.

10 Find the angle between $\mathbf{s} = \begin{pmatrix} 2 \\ 1 \\ -1 \end{pmatrix}$ and $\mathbf{t} = \begin{pmatrix} 3 \\ 0 \\ 3 \end{pmatrix}$, correct to the nearest degree.

11 If $\mathbf{r} = 2\mathbf{i} - 3\mathbf{j} + 6\mathbf{k}$ and $\mathbf{s} = 3\mathbf{i} + 4\mathbf{k}$ find

- a a unit vector in the same direction as \mathbf{r} ,
- b a vector in the same direction as \mathbf{r} but equal in magnitude to \mathbf{s} ,
- c a vector in the same direction as \mathbf{s} but equal in magnitude to \mathbf{r} ,
- d the angle between \mathbf{r} and \mathbf{s} (to the nearest degree).

12 For each of the following, state whether the given pair of vectors are parallel, perpendicular or neither of these.

- a $2\mathbf{i} - 3\mathbf{j} + \mathbf{k}$ and $4\mathbf{i} - 6\mathbf{j} + 2\mathbf{k}$
- b $3\mathbf{i} + 2\mathbf{j} - \mathbf{k}$ and $\mathbf{i} - \mathbf{j} + 3\mathbf{k}$
- c $\langle 1, 3, -2 \rangle$ and $\langle -2, 3, 1 \rangle$
- d $\langle 1, 2, 3 \rangle$ and $\langle 3, 3, -3 \rangle$

e $\begin{pmatrix} 3 \\ 2 \\ -1 \end{pmatrix}$ and $\begin{pmatrix} 5 \\ -7 \\ 1 \end{pmatrix}$ f $\begin{pmatrix} -2 \\ 6 \\ 8 \end{pmatrix}$ and $\begin{pmatrix} 1 \\ -3 \\ 4 \end{pmatrix}$ g $\begin{pmatrix} 3 \\ 1 \\ 5 \end{pmatrix}$ and $\begin{pmatrix} 6 \\ 2 \\ -4 \end{pmatrix}$

13 Find the magnitude of the resultant of the three forces

$$\mathbf{F}_1 = (5\mathbf{i} + 10\mathbf{j} + 5\mathbf{k}) \text{ N}, \quad \mathbf{F}_2 = (3\mathbf{i} + 5\mathbf{j} + 5\mathbf{k}) \text{ N} \quad \text{and} \quad \mathbf{F}_3 = (-2\mathbf{i} + 3\mathbf{j} - \mathbf{k}) \text{ N}.$$

14 Point A has position vector $2\mathbf{i} + 3\mathbf{j} - 4\mathbf{k}$ and $\overrightarrow{BA} = -\mathbf{i} + 3\mathbf{j} + 4\mathbf{k}$. Find the position vector of B.

15 Find vectors \mathbf{a} and \mathbf{b} such that $\mathbf{a} + \mathbf{b} = \begin{pmatrix} 7 \\ 1 \\ 2 \end{pmatrix}$ and $\mathbf{a} - \mathbf{b} = \begin{pmatrix} 3 \\ 3 \\ -4 \end{pmatrix}$.

16 If $\mathbf{a} = \begin{pmatrix} 2 \\ 3 \\ 1 \end{pmatrix}$, $\mathbf{b} = \begin{pmatrix} 4 \\ 6 \\ p \end{pmatrix}$, $\mathbf{c} = \begin{pmatrix} 7 \\ q \\ -2 \end{pmatrix}$ and $\mathbf{d} = \begin{pmatrix} 3 \\ -4 \\ r \end{pmatrix}$ find

- p, q and r given that:
- b is parallel to \mathbf{a} ,
 - c is perpendicular to \mathbf{a} ,
 - d is perpendicular to \mathbf{b} .

17 A particle has an initial position vector of $(-4\mathbf{i} - 4\mathbf{j} + 11\mathbf{k})$ m with respect to an origin O. The particle moves with constant velocity of $(2\mathbf{i} + 4\mathbf{j} - 2\mathbf{k})$ m/s. What will be the position vector of the particle after

- a 1 second?
- b 2 seconds?
- c How far will the particle be from O after 3 seconds?
- d After how many seconds will the particle be 15 metres from O?



- 18** Points A, B and C have position vectors $7\mathbf{i} + 5\mathbf{j}$, $3\mathbf{i} + \mathbf{j} - 4\mathbf{k}$ and $2\mathbf{i} - 5\mathbf{k}$ respectively. Prove that A, B and C are collinear.

- 19** Points A and B have position vectors $\begin{pmatrix} 3 \\ 4 \\ 4 \end{pmatrix}$ and $\begin{pmatrix} -2 \\ 9 \\ -1 \end{pmatrix}$ respectively. Find the position vector of the point that divides AB internally in the ratio 2 : 3.

- 20** Points A and B have position vectors $3\mathbf{i} + 2\mathbf{j} - \mathbf{k}$ and $4\mathbf{i} - \mathbf{j} + \mathbf{k}$ respectively. Find the position vector of the point P if $\overrightarrow{AB} = \overrightarrow{BP}$.

- 21** A and B have position vectors $5\mathbf{i} - 2\mathbf{j} + 3\mathbf{k}$ and $9\mathbf{i} + 6\mathbf{j} - 9\mathbf{k}$ respectively. Find the position vector of the point P if $\overrightarrow{AP} : \overrightarrow{AB} = 3 : 4$.

- 22** Points A, B and C have position vectors $2\mathbf{i} + 3\mathbf{j} + 2\mathbf{k}$, $3\mathbf{k}$ and $4\mathbf{i} - 3\mathbf{j} + 2\mathbf{k}$ respectively. Prove that $\triangle ABC$ is right-angled.

- 23** Find the acute angles that the vector $\mathbf{a} = 2\mathbf{i} + 3\mathbf{j} - \mathbf{k}$ makes with the x -, y - and z -axes. (Hint: Consider $\mathbf{a} \cdot \mathbf{i}$.)

- 24** If $\mathbf{a} = \mathbf{i} - 2\mathbf{j} + 3\mathbf{k}$, $\mathbf{b} = 2\mathbf{i} + \mathbf{j} - \mathbf{k}$ and $\mathbf{c} = 4\mathbf{i} - \mathbf{j} + 3\mathbf{k}$ express each of the following in the form $\lambda\mathbf{a} + \mu\mathbf{b} + \eta\mathbf{c}$.

$$\mathbf{d} = 7\mathbf{i} - 5\mathbf{j} + 10\mathbf{k},$$

$$\mathbf{e} = \mathbf{i} - 5\mathbf{j} + 8\mathbf{k},$$

$$\mathbf{f} = 2\mathbf{j} - 2\mathbf{k}.$$

- 25** A rectangular block ABCDEFGH is placed with DC along the x -axis, DA along the z -axis and DH along the y -axis (see diagram).

$$AB = 10 \text{ cm}, BC = 4 \text{ cm and } AE = 3 \text{ cm}.$$

I is on HE and $HI = 1 \text{ cm}$.

The unit vectors \mathbf{i} , \mathbf{j} and \mathbf{k} are along the x -, y - and z -axes respectively.

- a** Find \overrightarrow{DC} , \overrightarrow{DB} and \overrightarrow{DI} in the form $a\mathbf{i} + b\mathbf{j} + c\mathbf{k}$.

- b** Use vector techniques to determine $\angle IDB$ to the nearest degree.

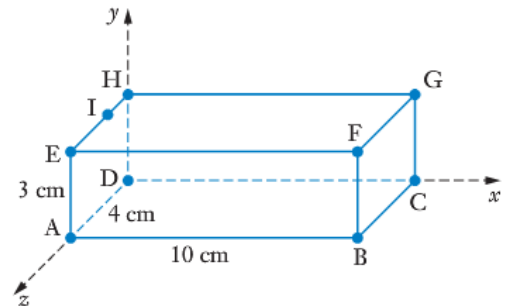

- 26** The right pyramid ABCDE is shown on the right with the coordinates of the vertices as indicated.

Use vector techniques to determine

- a** $\angle OAE$,

- b** the acute angle between the skew lines AE and DB.

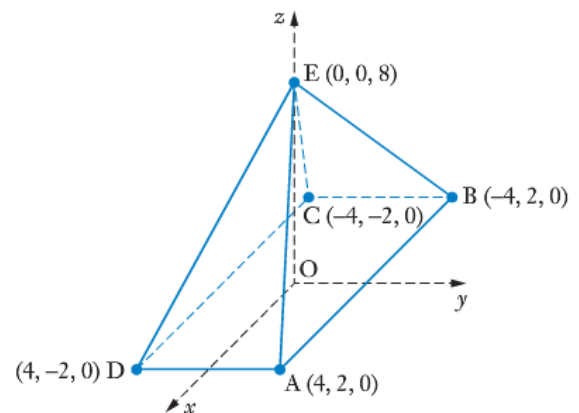

27 Points A, B and C have position vectors $\begin{pmatrix} -3 \\ 1 \\ 2 \end{pmatrix}$, $\begin{pmatrix} 3 \\ 3 \\ 3 \end{pmatrix}$ and $\begin{pmatrix} 2 \\ 1 \\ 6 \end{pmatrix}$ respectively.

- a** Find \vec{AB} , \vec{BC} and \vec{AC} .
- b** Prove that $\triangle ABC$ is isosceles.
- c** Find $\vec{AC} \cdot \vec{AC}$
- d** Find the angles of the triangle.

28 The diagram below left shows a cube OABCDEFG with

$$\vec{OA} = 1\mathbf{i} + 0\mathbf{j} + 0\mathbf{k},$$

$$\vec{OC} = 0\mathbf{i} + 1\mathbf{j} + 0\mathbf{k},$$

$$\vec{OD} = 0\mathbf{i} + 0\mathbf{j} + 1\mathbf{k}.$$

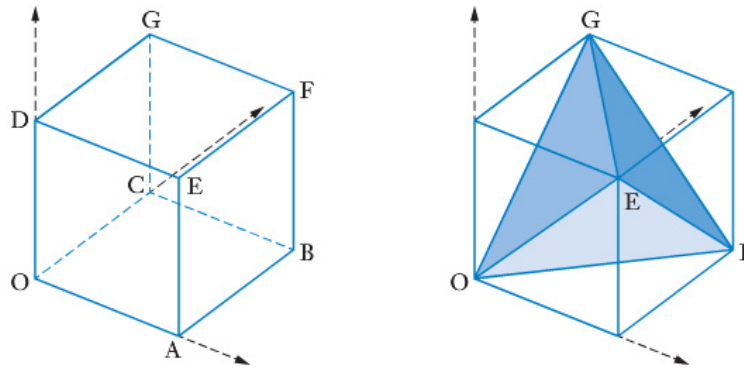

Prove that OBGE is a regular tetrahedron. (A regular tetrahedron has four congruent equilateral triangular faces.)

29 The diagram, right, shows a rectangular prism OABCDEFG with

$$\vec{OA} = \mathbf{a}, \quad \vec{OC} = \mathbf{c}, \quad \text{and} \quad \vec{OD} = \mathbf{d}.$$

Prove that the diagonals OF, AG, BD and CE intersect at their mid-points.

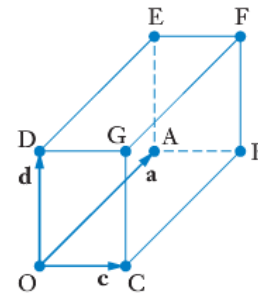

30 The diagram, right, shows a tetrahedron OABC with

$$\vec{OA} = \mathbf{a}, \quad \vec{OB} = \mathbf{b}, \quad \text{and} \quad \vec{OC} = \mathbf{c}.$$

The tetrahedron has three pairs of opposite edges:

$$OC \text{ and } BA, \quad OB \text{ and } CA, \quad OA \text{ and } CB.$$

Prove that if any two of these pairs involve perpendicular sides, e.g. OC perpendicular to BA and OB perpendicular to CA, then the third pair also involves perpendicular sides, i.e. OA is perpendicular to CB.

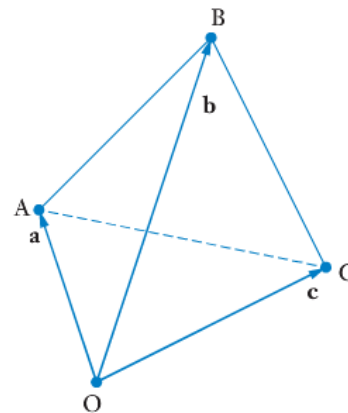

Vector product (cross product)

The point was made in the book for Unit One of the *Mathematics Specialist* course that the idea of forming a product of two vectors may initially seem rather confusing. How do we multiply together quantities which have magnitude and direction? Whilst we could define what we mean by vector multiplication in all sorts of ways there are two methods of performing vector multiplication that prove to be useful. One method of vector multiplication gives an answer that is a scalar. This is the **scalar product**, a concept we are already familiar with. A second method gives an answer that is a vector. We call this the **vector product**, a concept that we will consider now.

For vectors \mathbf{a} and \mathbf{b} the vector product is written $\mathbf{a} \times \mathbf{b}$, is also referred to as the *cross product* and is a vector perpendicular to both \mathbf{a} and \mathbf{b} . We say that $\mathbf{a} \times \mathbf{b}$ is a vector **normal** to the plane containing \mathbf{a} and \mathbf{b} .

Suppose, for example, that $\mathbf{a} = 2\mathbf{i} + 3\mathbf{j} - 5\mathbf{k}$,
and $\mathbf{b} = \mathbf{i} - 2\mathbf{j} + 3\mathbf{k}$.

Using a calculator $\mathbf{a} \times \mathbf{b} = -\mathbf{i} - 11\mathbf{j} - 7\mathbf{k}$

The working below confirms that this vector is perpendicular to both \mathbf{a} and \mathbf{b} :

$$(2\mathbf{i} + 3\mathbf{j} - 5\mathbf{k}) \cdot (-\mathbf{i} - 11\mathbf{j} - 7\mathbf{k}) = -2 - 33 + 35 \\ = 0$$

$$(\mathbf{i} - 2\mathbf{j} + 3\mathbf{k}) \cdot (-\mathbf{i} - 11\mathbf{j} - 7\mathbf{k}) = -1 + 22 - 21 \\ = 0$$

$$\text{crossP}\left(\begin{bmatrix} 2 \\ 3 \\ -5 \end{bmatrix}, \begin{bmatrix} 1 \\ -2 \\ 3 \end{bmatrix}\right) = \begin{bmatrix} -1 \\ -11 \\ -7 \end{bmatrix}$$

The vector product of two vectors can be determined from the \mathbf{i} - \mathbf{j} - \mathbf{k} components as follows.

If $\mathbf{a} = a_1\mathbf{i} + a_2\mathbf{j} + a_3\mathbf{k}$
and $\mathbf{b} = b_1\mathbf{i} + b_2\mathbf{j} + b_3\mathbf{k}$
then $\mathbf{a} \times \mathbf{b} = (a_2b_3 - a_3b_2)\mathbf{i} - (a_1b_3 - a_3b_1)\mathbf{j} + (a_1b_2 - a_2b_1)\mathbf{k}$

This formula may appear complicated but if we write $\begin{vmatrix} a & b \\ c & d \end{vmatrix}$ to represent $ad - bc$ (which you may recognise as the determinant of the 2×2 matrix) then:

$$\begin{array}{ccc} \mathbf{i} & \mathbf{j} & \mathbf{k} \\ \begin{array}{ccc} a_1 & a_2 & a_3 \\ b_1 & b_2 & b_3 \end{array} & \begin{array}{ccc} a_1 & a_2 & a_3 \\ b_1 & b_2 & b_3 \end{array} & \begin{array}{ccc} a_1 & a_2 & a_3 \\ b_1 & b_2 & b_3 \end{array} \\ \begin{array}{c} \swarrow \quad \searrow \\ \begin{vmatrix} a_2 & a_3 \\ b_2 & b_3 \end{vmatrix} \end{array} & - & \begin{array}{c} \swarrow \quad \searrow \\ \begin{vmatrix} a_1 & a_3 \\ b_1 & b_3 \end{vmatrix} \end{array} & + & \begin{array}{c} \swarrow \quad \searrow \\ \begin{vmatrix} a_1 & a_2 \\ b_1 & b_2 \end{vmatrix} \end{array} \\ \mathbf{a} \times \mathbf{b} = (a_2b_3 - a_3b_2)\mathbf{i} & - & (a_1b_3 - a_3b_1)\mathbf{j} & + & (a_1b_2 - a_2b_1)\mathbf{k} \end{array}$$

EXAMPLE 5

With $\mathbf{c} = 4\mathbf{i} - \mathbf{j} + 3\mathbf{k}$ and $\mathbf{d} = -\mathbf{i} + 2\mathbf{j} - \mathbf{k}$ determine $\mathbf{c} \times \mathbf{d}$ and confirm that your answer is indeed a vector that is perpendicular to both \mathbf{c} and \mathbf{d} .

Solution

$$\begin{array}{r} \mathbf{c} \times \mathbf{d} = \begin{vmatrix} 4 & -1 & 3 \\ -1 & 2 & -1 \end{vmatrix} \\ = (1 - 6)\mathbf{i} - (-4 + 3)\mathbf{j} + (8 - 1)\mathbf{k} \\ = -5\mathbf{i} + \mathbf{j} + 7\mathbf{k} \end{array}$$

$$\begin{array}{l} \mathbf{c} \cdot (-5\mathbf{i} + \mathbf{j} + 7\mathbf{k}) = (4\mathbf{i} - \mathbf{j} + 3\mathbf{k}) \cdot (-5\mathbf{i} + \mathbf{j} + 7\mathbf{k}) \\ = -20 - 1 + 21 \\ = 0 \end{array} \quad \begin{array}{l} -5\mathbf{i} + \mathbf{j} + 7\mathbf{k} \text{ is perpendicular to } \mathbf{c}. \end{array}$$

$$\begin{array}{l} \mathbf{d} \cdot (-5\mathbf{i} + \mathbf{j} + 7\mathbf{k}) = (-\mathbf{i} + 2\mathbf{j} - \mathbf{k}) \cdot (-5\mathbf{i} + \mathbf{j} + 7\mathbf{k}) \\ = 5 + 2 - 7 \\ = 0 \end{array} \quad \begin{array}{l} -5\mathbf{i} + \mathbf{j} + 7\mathbf{k} \text{ is perpendicular to } \mathbf{d}. \end{array}$$

Note • The syllabus for this unit, at the time of writing, says that students studying the unit should be able to ‘use the cross product to determine a vector normal to a given plane’. Whilst we will concentrate on such use in this book it is also worth noting that just as the scalar product, in addition to being determinable from the \mathbf{i} - \mathbf{j} - \mathbf{k} components, also has the meaning

$$\mathbf{a} \cdot \mathbf{b} = |\mathbf{a}||\mathbf{b}| \cos \theta, \text{ where } \theta \text{ is the angle between } \mathbf{a} \text{ and } \mathbf{b},$$

then so, not proved here,

$$|\mathbf{a} \times \mathbf{b}| = |\mathbf{a}||\mathbf{b}| \sin \theta, \text{ where } \theta \text{ is the angle between } \mathbf{a} \text{ and } \mathbf{b}.$$

If $\hat{\mathbf{n}}$ is a unit vector (i.e. a vector of unit length) in the direction of $\mathbf{a} \times \mathbf{b}$ then this could be written

$$\mathbf{a} \times \mathbf{b} = |\mathbf{a}||\mathbf{b}| \sin \theta \hat{\mathbf{n}}.$$

- The previous dot point means that we can interpret $|\mathbf{a} \times \mathbf{b}|$ as being the area of a parallelogram that has \mathbf{a} and \mathbf{b} as adjacent sides.

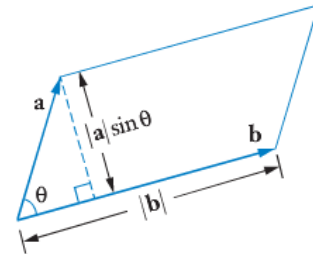

- There are two possible directions for a vector perpendicular to the plane containing vector \mathbf{a} and \mathbf{b} , as the vectors \mathbf{n}_1 and \mathbf{n}_2 indicate in the diagram on the right. To determine which of these is the direction of $\mathbf{a} \times \mathbf{b}$ we again use the right hand screw rule. If we rotate a normal screw from \mathbf{a} to \mathbf{b} , the direction the screw would move tells us the direction of $\mathbf{a} \times \mathbf{b}$. In this case the direction of \mathbf{n}_1 .

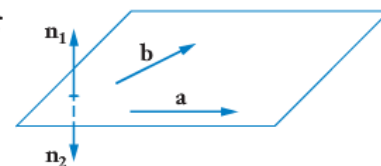

$\mathbf{b} \times \mathbf{a}$ would be in the direction of \mathbf{n}_2 .



Exercise 5B

- 1 The fact that $|\mathbf{a} \times \mathbf{b}| = |\mathbf{a}||\mathbf{b}| \sin \theta$ means that two parallel vectors should have a cross product equal to the zero vector.

Prove that the method for determining the cross product of two vectors from their \mathbf{i} - \mathbf{j} - \mathbf{k} components also gives the zero vector if the two vectors are parallel.

- 2 With $\mathbf{a} = 2\mathbf{i} + 3\mathbf{j} - \mathbf{k}$ and $\mathbf{b} = -\mathbf{i} + 3\mathbf{j} + \mathbf{k}$ determine the vector product $\mathbf{a} \times \mathbf{b}$ and confirm that your answer is indeed a vector that is perpendicular to both \mathbf{a} and \mathbf{b} .
- 3 With $\mathbf{c} = 5\mathbf{i} + \mathbf{k}$ and $\mathbf{d} = \mathbf{i} + \mathbf{j} + \mathbf{k}$ determine the vector product $\mathbf{c} \times \mathbf{d}$ and confirm that your answer is indeed a vector that is perpendicular to both \mathbf{c} and \mathbf{d} .
- 4 With $\mathbf{p} = \mathbf{i} + 3\mathbf{j} - 2\mathbf{k}$ and $\mathbf{q} = -\mathbf{i} + 6\mathbf{j} - 4\mathbf{k}$ determine the vector product $\mathbf{p} \times \mathbf{q}$ and confirm that your answer is indeed a vector that is perpendicular to both \mathbf{p} and \mathbf{q} .
- 5 Without applying the formula, but just by applying some thought, what would you expect $\mathbf{a} \times \mathbf{b}$ to equal if $\mathbf{a} = \mathbf{i}$ and $\mathbf{b} = \mathbf{j}$?
Now apply the formula for determining the cross product of two vectors from their \mathbf{i} - \mathbf{j} - \mathbf{k} components to determine $\mathbf{i} \times \mathbf{j}$.
- 6 **a** If $\mathbf{a} = -\mathbf{i} + 2\mathbf{j} - \mathbf{k}$ and $\mathbf{b} = -3\mathbf{i} + 2\mathbf{j} - \mathbf{k}$ determine $\mathbf{a} \times \mathbf{b}$ and hence $|\mathbf{a} \times \mathbf{b}|$.
b Use the scalar product to determine, θ , the angle between the two vectors, and hence determine $|\mathbf{a} \times \mathbf{b}|$ using the fact that $|\mathbf{a} \times \mathbf{b}| = |\mathbf{a}||\mathbf{b}| \sin \theta$.
- 7 Determine a unit vector normal to the plane containing the vectors:

$$\mathbf{p} = 2\mathbf{i} - 3\mathbf{j} + \mathbf{k} \quad \text{and} \quad \mathbf{q} = \mathbf{i} + 2\mathbf{j} - 3\mathbf{k}$$

- 8 The three points A, B and C, have position vectors $\begin{pmatrix} 1 \\ 1 \\ 1 \end{pmatrix}$, $\begin{pmatrix} -2 \\ 1 \\ 3 \end{pmatrix}$ and $\begin{pmatrix} 0 \\ 2 \\ 1 \end{pmatrix}$ respectively.

Find a unit vector perpendicular to the plane containing A, B and C.

Vector equation of a line

The vector equation of a line must be some rule that the position vector of all points on the line obey whilst all points not on the line do not obey. This can be done in three dimensions, just as it could in two dimensions, by the rule

$$\mathbf{r} = \mathbf{a} + \lambda\mathbf{b}$$

where \mathbf{a} is the position vector of one point on the line,
 \mathbf{b} is a vector parallel to the line
 and λ is some scalar.

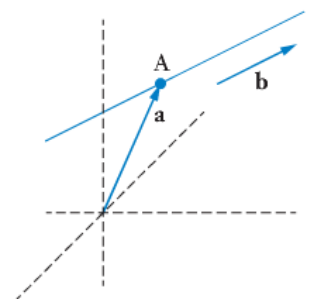

However, whilst in two dimensions we also had the scalar product form of the vector equation of a straight line, $\mathbf{r} \cdot \mathbf{n} = c$ ($= \mathbf{a} \cdot \mathbf{n}$) as mentioned in the previous chapter, this is not the case in three dimensions. This is because, in three dimensions, there are many lines that pass through the point with position vector \mathbf{a} and are perpendicular to vector \mathbf{n} . These lines together form the plane perpendicular to \mathbf{n} and containing the point with position vector \mathbf{a} , as we will see when we consider the vector equation of a plane.

EXAMPLE 6

A line passes through the point with position vector $2\mathbf{i} - \mathbf{j} + 3\mathbf{k}$ and is parallel to $\mathbf{i} + \mathbf{j} + \mathbf{k}$.

- Find
- a** the vector equation of the line,
 - b** the parametric equations of the line.

Solution

- a** A line through A, position vector \mathbf{a} , parallel to \mathbf{b} , has equation $\mathbf{r} = \mathbf{a} + \lambda\mathbf{b}$.
Thus the given line has vector equation $\mathbf{r} = 2\mathbf{i} - \mathbf{j} + 3\mathbf{k} + \lambda(\mathbf{i} + \mathbf{j} + \mathbf{k})$.
- b** If $\mathbf{r} = x\mathbf{i} + y\mathbf{j} + z\mathbf{k}$ then $x\mathbf{i} + y\mathbf{j} + z\mathbf{k} = 2\mathbf{i} - \mathbf{j} + 3\mathbf{k} + \lambda(\mathbf{i} + \mathbf{j} + \mathbf{k})$.

Thus the parametric equations are:

$$\begin{cases} x = 2 + \lambda \\ y = -1 + \lambda \\ z = 3 + \lambda \end{cases}$$

Note: Eliminating λ from the parametric equations give the set of equations:

$$x - 2 = y + 1 = z - 3.$$

To generalise, the vector equation $\mathbf{r} = a\mathbf{i} + b\mathbf{j} + c\mathbf{k} + \lambda(p\mathbf{i} + q\mathbf{j} + r\mathbf{k})$

will give:

$$\frac{x - a}{p} = \frac{y - b}{q} = \frac{z - c}{r}.$$

These are the cartesian equations of a line through (a, b, c) and parallel to the vector $p\mathbf{i} + q\mathbf{j} + r\mathbf{k}$. This is mentioned here for the sake of completeness. The set of cartesian equations for a line in three-dimensional space is not specifically mentioned in the syllabus for this unit.

EXAMPLE 7

Show that the lines $L_1: \mathbf{r} = \begin{pmatrix} 7 \\ 3 \\ -2 \end{pmatrix} + \lambda \begin{pmatrix} 2 \\ 4 \\ -1 \end{pmatrix}$ and $L_2: \mathbf{r} = \begin{pmatrix} 0 \\ -1 \\ 14 \end{pmatrix} + \mu \begin{pmatrix} 1 \\ 0 \\ -3 \end{pmatrix}$ intersect and

find the position vector of this point of intersection.

Solution

If the lines intersect there must exist values of λ and μ for which

$$\begin{pmatrix} 7 \\ 3 \\ -2 \end{pmatrix} + \lambda \begin{pmatrix} 2 \\ 4 \\ -1 \end{pmatrix} = \begin{pmatrix} 0 \\ -1 \\ -14 \end{pmatrix} + \mu \begin{pmatrix} 1 \\ 0 \\ -3 \end{pmatrix}$$

i.e. $7 + 2\lambda = \mu,$ [1]

$3 + 4\lambda = -1,$ [2]

and $-2 - \lambda = 14 - 3\mu.$ [3]

Solving [1] and [2] gives $\lambda = -1$ and $\mu = 5,$

values which are consistent with equation [3]: $-2 + 1 = 14 - 15$

Hence L_1 and L_2 intersect at the point with position vector $\begin{pmatrix} 5 \\ -1 \\ -1 \end{pmatrix}$.



Vector equation of a plane

The vector equation of a plane needs to be a rule that the position vector of all points lying in the plane obey, and that all points not in the plane do not obey.

One way this can be achieved is to give the general position vector, \mathbf{r} , in terms of \mathbf{a} , the position vector of one point in the plane, and two other non-parallel vectors, \mathbf{b} and \mathbf{c} , that are parallel to the plane.

I.e.
$$\mathbf{r} = \mathbf{a} + \lambda\mathbf{b} + \mu\mathbf{c}$$

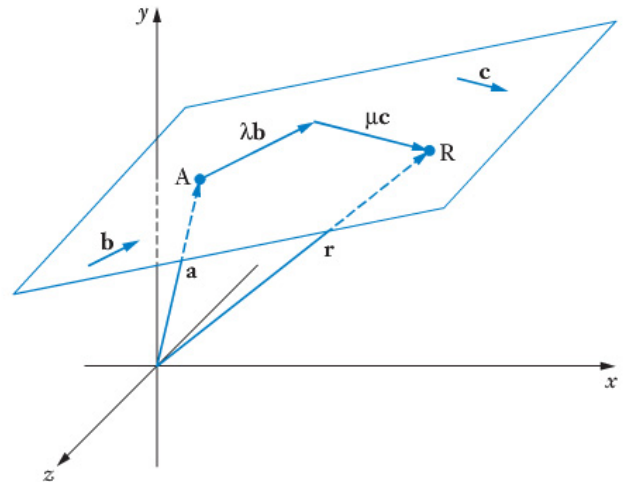

The plane containing a point with position vector \mathbf{a} and parallel to the non-parallel vectors \mathbf{b} and \mathbf{c} has equation $\mathbf{r} = \mathbf{a} + \lambda\mathbf{b} + \mu\mathbf{c}$.

For example, the plane containing point A, position vector $\begin{pmatrix} 3 \\ 2 \\ -1 \end{pmatrix}$ and parallel to $\begin{pmatrix} 2 \\ 3 \\ 1 \end{pmatrix}$ and $\begin{pmatrix} 1 \\ 5 \\ 4 \end{pmatrix}$

has equation:

$$\mathbf{r} = \begin{pmatrix} 3 \\ 2 \\ -1 \end{pmatrix} + \lambda \begin{pmatrix} 2 \\ 3 \\ 1 \end{pmatrix} + \mu \begin{pmatrix} 1 \\ 5 \\ 4 \end{pmatrix}.$$

Alternatively the plane can be defined by giving \mathbf{a} , the position vector of one point in the plane, and \mathbf{n} , a vector that is perpendicular to the plane.

It then follows that

$$(\mathbf{r} - \mathbf{a}) \cdot \mathbf{n} = 0$$

i.e. $\mathbf{r} \cdot \mathbf{n} = \mathbf{a} \cdot \mathbf{n}$

i.e. $\mathbf{r} \cdot \mathbf{n} = c$

Thus, in three dimensions, $\mathbf{r} \cdot \mathbf{n} = c$ is the equation of a plane.

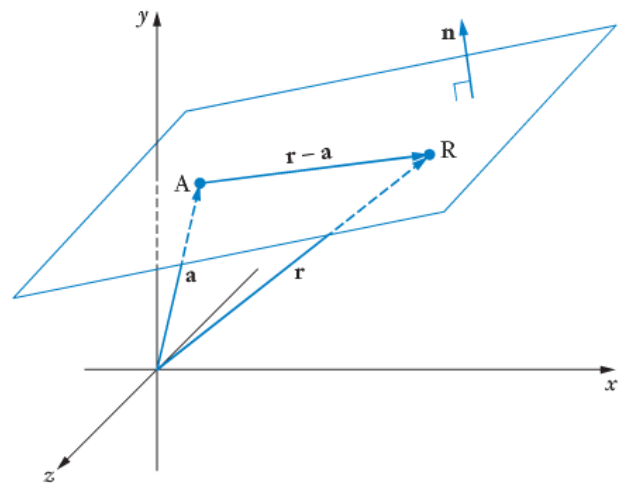

The plane containing a point with position vector \mathbf{a} and perpendicular to the vector \mathbf{n} has equation $(\mathbf{r} - \mathbf{a}) \cdot \mathbf{n} = 0$.

Knowing \mathbf{a} and \mathbf{n} this becomes $\mathbf{r} \cdot \mathbf{n} = c$, where $c = \mathbf{a} \cdot \mathbf{n}$.

For example, the plane containing point A, position vector $\begin{pmatrix} 1 \\ 4 \\ 2 \end{pmatrix}$ and perpendicular to $\begin{pmatrix} 1 \\ -1 \\ 3 \end{pmatrix}$ has

the equation:
$$\mathbf{r} \cdot \begin{pmatrix} 1 \\ -1 \\ 3 \end{pmatrix} = \begin{pmatrix} 1 \\ 4 \\ 2 \end{pmatrix} \cdot \begin{pmatrix} 1 \\ -1 \\ 3 \end{pmatrix}$$

i.e.
$$\mathbf{r} \cdot \begin{pmatrix} 1 \\ -1 \\ 3 \end{pmatrix} = 3$$

Writing \mathbf{r} as $\begin{pmatrix} x \\ y \\ z \end{pmatrix}$ this becomes
$$\begin{pmatrix} x \\ y \\ z \end{pmatrix} \cdot \begin{pmatrix} 1 \\ -1 \\ 3 \end{pmatrix} = 3$$

i.e.
$$x - y + 3z = 3$$

This is the **cartesian equation** of the plane. Notice that the coefficients of x, y and z , i.e. $(1, -1, 3)$ allow us to quickly determine a vector perpendicular to the plane, i.e. the vector $\mathbf{i} - \mathbf{j} + 3\mathbf{k}$.

EXAMPLE 8

Line L has vector equation: $\mathbf{r} = 7\mathbf{i} + 3\mathbf{j} + 5\mathbf{k} + \lambda(3\mathbf{i} - \mathbf{j} + 2\mathbf{k})$

Plane Π has vector equation: $\mathbf{r} \cdot (5\mathbf{i} + 3\mathbf{j} - 6\mathbf{k}) = 14$

- a** Show that point A, position vector $\mathbf{i} + 5\mathbf{j} + \mathbf{k}$, lies on L and in Π .
- b** Show that line L lies in the plane Π .

Solution

- a** If A lies on L there must exist some λ for which

$$\mathbf{i} + 5\mathbf{j} + \mathbf{k} = 7\mathbf{i} + 3\mathbf{j} + 5\mathbf{k} + \lambda(3\mathbf{i} - \mathbf{j} + 2\mathbf{k})$$

i.e. $1 = 7 + 3\lambda, (\lambda = -2), \quad 5 = 3 - \lambda, (\lambda = -2) \quad \text{and} \quad 1 = 5 + 2\lambda, (\lambda = -2).$

Hence such a value of λ does exist and so point A lies on L.

Also
$$(\mathbf{i} + 5\mathbf{j} + \mathbf{k}) \cdot (5\mathbf{i} + 3\mathbf{j} - 6\mathbf{k}) = 5 + 15 - 6 = 14$$

The position vector of A satisfies the equation of Π . Point A lies in Π .

- b** If two points on L lie in Π then the line must lie in the plane. We already know A is on the line and in the plane. With $\lambda = 0$ we have $7\mathbf{i} + 3\mathbf{j} + 5\mathbf{k}$, the position vector of another point on the line.

Also
$$(7\mathbf{i} + 3\mathbf{j} + 5\mathbf{k}) \cdot (5\mathbf{i} + 3\mathbf{j} - 6\mathbf{k}) = 14$$

Thus we have two points on L that lie in the plane Π . The line L lies in Π .

- Alternatively
- show that $\mathbf{r} = 7\mathbf{i} + 3\mathbf{j} + 5\mathbf{k} + \lambda(3\mathbf{i} - \mathbf{j} + 2\mathbf{k})$ satisfies $\mathbf{r} \cdot (5\mathbf{i} + 3\mathbf{j} - 6\mathbf{k}) = 14$ for all λ
 - or • show that L is also perpendicular to $5\mathbf{i} + 3\mathbf{j} - 6\mathbf{k}$, and hence, with one point known to be in common, L lies in Π .



EXAMPLE 9

Find, in the form $\mathbf{r} = \mathbf{a} + \lambda\mathbf{b} + \mu\mathbf{c}$, the vector equation of the plane containing the line with vector

$$\text{equation } \mathbf{r} = \begin{pmatrix} -1 \\ 3 \\ 5 \end{pmatrix} + \lambda \begin{pmatrix} 2 \\ 4 \\ -1 \end{pmatrix} \text{ and the point } \begin{pmatrix} -1 \\ 5 \\ 3 \end{pmatrix}.$$

Solution

The given line is parallel to $\begin{pmatrix} 2 \\ 4 \\ -1 \end{pmatrix}$ and so the plane must be parallel to $\begin{pmatrix} 2 \\ 4 \\ -1 \end{pmatrix}$.

Putting $\lambda = 0$ gives the point $\begin{pmatrix} -1 \\ 3 \\ 5 \end{pmatrix}$ as a point on the line, and hence in the plane. Thus

$\begin{pmatrix} -1 \\ 5 \\ 3 \end{pmatrix} - \begin{pmatrix} -1 \\ 3 \\ 5 \end{pmatrix}$, i.e. $\begin{pmatrix} 0 \\ 2 \\ -2 \end{pmatrix}$, must be a vector parallel to the plane.

The required equation can be written: $\mathbf{r} = \begin{pmatrix} -1 \\ 5 \\ 3 \end{pmatrix} + \lambda \begin{pmatrix} 2 \\ 4 \\ -1 \end{pmatrix} + \mu \begin{pmatrix} 0 \\ 2 \\ -2 \end{pmatrix}$

EXAMPLE 10

Find the position vector of the point where the line

$$\mathbf{r} = 2\mathbf{i} + 3\mathbf{j} - \mathbf{k} + \lambda(\mathbf{i} + 4\mathbf{j} - 2\mathbf{k})$$

meets the plane $\mathbf{r} \cdot (-3\mathbf{i} + \mathbf{j} + \mathbf{k}) = 1$.

Solution

The position vector of the point where the line meets the plane will 'fit' both the equation of the line and that of the plane. If this position vector is \mathbf{a} then

$$\mathbf{a} = 2\mathbf{i} + 3\mathbf{j} - \mathbf{k} + \lambda(\mathbf{i} + 4\mathbf{j} - 2\mathbf{k})$$

and $\mathbf{a} \cdot (-3\mathbf{i} + \mathbf{j} + \mathbf{k}) = 1$

$$\text{Thus } \begin{pmatrix} 2 + \lambda \\ 3 + 4\lambda \\ -1 - 2\lambda \end{pmatrix} \cdot \begin{pmatrix} -3 \\ 1 \\ 1 \end{pmatrix} = 1$$

$$\therefore -6 - 3\lambda + 3 + 4\lambda - 1 - 2\lambda = 1$$

$$\text{Solving gives } \lambda = -5$$

$$\text{Hence } \mathbf{a} = 2\mathbf{i} + 3\mathbf{j} - \mathbf{k} - 5(\mathbf{i} + 4\mathbf{j} - 2\mathbf{k}) \\ = -3\mathbf{i} - 17\mathbf{j} + 9\mathbf{k}$$

The line meets the plane at the point with position vector $-3\mathbf{i} - 17\mathbf{j} + 9\mathbf{k}$.

Note that whilst the matrix form of vector representation was used for a while in the working of the previous example the final answer was given in the format used in the question, i.e. in the form $a\mathbf{i} + b\mathbf{j} + c\mathbf{k}$.



Given three points that lie in the plane

A plane can also be uniquely defined by giving three non-collinear points that lie in the plane. Hence, given three such points we should be able to determine the equation of the plane.

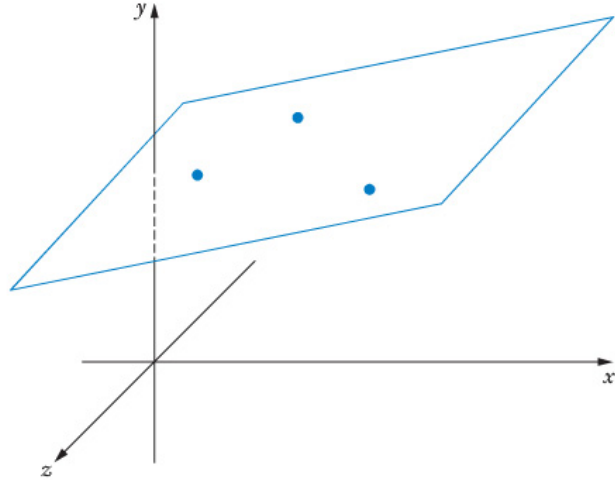

EXAMPLE 11

A plane contains three points, position vectors $-2\mathbf{i} - 2\mathbf{j} + \mathbf{k}$,
 $10\mathbf{i} - 6\mathbf{j} - 3\mathbf{k}$,
 and $-9\mathbf{i} + 5\mathbf{j} + 4\mathbf{k}$.

Find the vector equation of the plane in the form

- a $ax + by + cz = d$
- b $\mathbf{r} \cdot \mathbf{n} = c$
- c $\mathbf{r} = \mathbf{a} + \lambda\mathbf{b} + \mu\mathbf{c}$

Solution

- a The coordinates $(-2, -2, 1)$, $(10, -6, -3)$ and $(-9, 5, 4)$ must each 'fit' the equation $ax + by + cz = d$.

$$\text{Hence } \begin{cases} -2a - 2b + c = d \\ 10a - 6b - 3c = d \\ -9a + 5b + 4c = d \end{cases}$$

With the assistance of a calculator we solve for a , b and c to obtain each in terms of d :

$$a = \frac{2}{5}d, \quad b = -\frac{1}{5}d, \quad c = \frac{7}{5}d.$$

Hence the equation is of the form

$$\frac{2}{5}dx - \frac{1}{5}dy + \frac{7}{5}dz = d.$$

Dividing by d and multiplying by 5 the equation can be written as

$$2x - y + 7z = 5$$

- b From our answer to a the vector $2\mathbf{i} - \mathbf{j} + 7\mathbf{k}$ is perpendicular to the plane.

Hence the required equation is

$$\mathbf{r} \cdot (2\mathbf{i} - \mathbf{j} + 7\mathbf{k}) = 5$$

$$\begin{cases} -2a - 2b + c = d \\ 10a - 6b - 3c = d \\ -9a + 5b + 4c = d \end{cases} \Bigg|_{a, b, c}$$

$$\left\{ a = \frac{2 \cdot d}{5}, b = -\frac{d}{5}, c = \frac{7 \cdot d}{5} \right\}$$



Alternatively we could use the cross product to determine a vector perpendicular to the plane, as shown below.

With points with position vectors $-2\mathbf{i} - 2\mathbf{j} + \mathbf{k}$, $10\mathbf{i} - 6\mathbf{j} - 3\mathbf{k}$ and $-9\mathbf{i} + 5\mathbf{j} + 4\mathbf{k}$ lying in the plane it follows that

$$\begin{array}{l} (10\mathbf{i} - 6\mathbf{j} - 3\mathbf{k}) - (-2\mathbf{i} - 2\mathbf{j} + \mathbf{k}) \quad \text{and} \quad (10\mathbf{i} - 6\mathbf{j} - 3\mathbf{k}) - (-9\mathbf{i} + 5\mathbf{j} + 4\mathbf{k}) \\ \text{i.e.} \quad 12\mathbf{i} - 4\mathbf{j} - 4\mathbf{k} \quad \quad \quad \text{and} \quad \quad \quad 19\mathbf{i} - 11\mathbf{j} - 7\mathbf{k} \end{array}$$

must be parallel to the plane.

Thus a vector perpendicular to the plane will be

$$\begin{aligned} & (3\mathbf{i} - \mathbf{j} - \mathbf{k}) \times (19\mathbf{i} - 11\mathbf{j} - 7\mathbf{k}) \\ &= -4\mathbf{i} + 2\mathbf{j} - 14\mathbf{k} \\ &= -2(2\mathbf{i} - \mathbf{j} + 7\mathbf{k}). \end{aligned}$$

i.e. $2\mathbf{i} - \mathbf{j} + 7\mathbf{k}$ is perpendicular to the plane.

$$\text{crossP}\left(\begin{bmatrix} 3 \\ -1 \\ -1 \end{bmatrix}, \begin{bmatrix} 19 \\ -11 \\ -7 \end{bmatrix}\right) = \begin{bmatrix} -4 \\ 2 \\ -14 \end{bmatrix}$$

The required equation is $\mathbf{r} \cdot (2\mathbf{i} - \mathbf{j} + 7\mathbf{k}) = (-2\mathbf{i} - 2\mathbf{j} + \mathbf{k}) \cdot (2\mathbf{i} - \mathbf{j} + 7\mathbf{k})$
giving $\mathbf{r} \cdot (2\mathbf{i} - \mathbf{j} + 7\mathbf{k}) = 5$, as before.

- c We determined above that the vectors $12\mathbf{i} - 4\mathbf{j} - 4\mathbf{k}$ and $19\mathbf{i} - 11\mathbf{j} - 7\mathbf{k}$ are parallel to the plane. Hence the required equation can be written

$$\mathbf{r} = -2\mathbf{i} - 2\mathbf{j} + \mathbf{k} + \lambda(12\mathbf{i} - 4\mathbf{j} - 4\mathbf{k}) + \mu(19\mathbf{i} - 11\mathbf{j} - 7\mathbf{k})$$

Note • We could equally well have written the answer to part c as:

$$\mathbf{r} = 10\mathbf{i} - 6\mathbf{j} - 3\mathbf{k} + \lambda(12\mathbf{i} - 4\mathbf{j} - 4\mathbf{k}) + \mu(19\mathbf{i} - 11\mathbf{j} - 7\mathbf{k})$$

or even (needs thought):

$$\mathbf{r} = 10\mathbf{i} - 6\mathbf{j} - 3\mathbf{k} + \lambda(3\mathbf{i} - \mathbf{j} - \mathbf{k}) + \mu(-19\mathbf{i} + 11\mathbf{j} + 7\mathbf{k})$$

or even (needs more thought):

$$\mathbf{r} = -9\mathbf{i} + 5\mathbf{j} + 4\mathbf{k} + \lambda(7\mathbf{i} - 7\mathbf{j} - 3\mathbf{k}) + \mu(-3\mathbf{i} + \mathbf{j} + \mathbf{k}).$$

Whilst these equations may appear different they all define the same plane, the plane with cartesian equation $2x - y + 7z = 5$.

- Justification that our answer to part c, i.e.

$$\mathbf{r} = -2\mathbf{i} - 2\mathbf{j} + \mathbf{k} + \lambda(12\mathbf{i} - 4\mathbf{j} - 4\mathbf{k}) + \mu(19\mathbf{i} - 11\mathbf{j} - 7\mathbf{k})$$

is equivalent to the cartesian equation $2x - y + 7z = 5$ follows:

Substituting $\mathbf{r} = x\mathbf{i} + y\mathbf{j} + z\mathbf{k}$ leads us to the equations:

$$x = -2 + 12\lambda + 19\mu \quad [1]$$

$$y = -2 - 4\lambda - 11\mu \quad [2]$$

$$z = 1 - 4\lambda - 7\mu \quad [3]$$

$$[2] - [3] \text{ gives } y - z = -3 - 4\mu \quad \text{i.e.} \quad \mu = \frac{-3 - y + z}{4}$$

$$[1] + 3 \times [3] \text{ gives } x + 3z = 1 - 2\mu \quad \text{i.e.} \quad \mu = \frac{1 - x - 3z}{2}$$

$$\text{Hence} \quad \frac{-3 - y + z}{4} = \frac{1 - x - 3z}{2}$$

which simplifies to $2x - y + 7z = 5$, as required.



Inteception/collision

When we restricted our attention to two dimensions we found the vector equation of a line a useful approach when solving inteception/collision questions.

When solving such questions we tended to replace λ in the equation $\mathbf{r} = \mathbf{a} + \lambda\mathbf{b}$ by t , for time.

This approach can also be used for these questions when three-dimensional space is involved, as the next example shows.

EXAMPLE 12

At time $t = 0$ the position vectors (\mathbf{r} m) and velocity vectors (\mathbf{v} m/s) of two particles A and B are as given below:

$$\mathbf{r}_A = \begin{pmatrix} 5 \\ -3 \\ 7 \end{pmatrix} \quad \mathbf{v}_A = \begin{pmatrix} 2 \\ 1 \\ 4 \end{pmatrix} \quad \mathbf{r}_B = \begin{pmatrix} -10 \\ 27 \\ -8 \end{pmatrix} \quad \mathbf{v}_B = \begin{pmatrix} 3 \\ -1 \\ 5 \end{pmatrix}$$

Show that if the particles continue with these velocities they will collide and find the time of collision and the position vector of its location.

Solution

At time t seconds the position vectors of A and B will be $\mathbf{r}_A(t)$ and $\mathbf{r}_B(t)$ with:

$$\mathbf{r}_A(t) = \begin{pmatrix} 5 \\ -3 \\ 7 \end{pmatrix} + t \begin{pmatrix} 2 \\ 1 \\ 4 \end{pmatrix} \quad \text{and} \quad \mathbf{r}_B(t) = \begin{pmatrix} -10 \\ 27 \\ -8 \end{pmatrix} + t \begin{pmatrix} 3 \\ -1 \\ 5 \end{pmatrix}.$$

For collision to occur there must be some value of t for which

$$\begin{pmatrix} 5 \\ -3 \\ 7 \end{pmatrix} + t \begin{pmatrix} 2 \\ 1 \\ 4 \end{pmatrix} = \begin{pmatrix} -10 \\ 27 \\ -8 \end{pmatrix} + t \begin{pmatrix} 3 \\ -1 \\ 5 \end{pmatrix}.$$

$$\text{I.e.} \quad 5 + 2t = -10 + 3t \quad \text{Solving gives } t = 15.$$

$$-3 + t = 27 - t \quad \text{Solving gives } t = 15.$$

$$\text{and} \quad 7 + 4t = -8 + 5t \quad \text{Solving gives } t = 15.$$

The particles will collide when $t = 15$ at the point with position vector $\begin{pmatrix} 35 \\ 12 \\ 67 \end{pmatrix}$.



Exercise 5C

- 1** A line passes through the point with position vector $3\mathbf{i} + 2\mathbf{j} - \mathbf{k}$
and is parallel to $2\mathbf{i} - \mathbf{j} + 2\mathbf{k}$.
- Find **a** the vector equation of the line,
b the parametric equations of the line.
- 2** A line passes through point A, position vector $4\mathbf{i} + 2\mathbf{j} + 3\mathbf{k}$, and point B, position vector $3\mathbf{i} + \mathbf{j} + \mathbf{k}$.
- Find **a** the vector equation of the line,
b the parametric equations of the line.
- 3** Write a vector equation for the plane that is perpendicular to the vector $3\mathbf{i} - \mathbf{j} + 5\mathbf{k}$ and that contains the point A, position vector $2\mathbf{i} - 3\mathbf{j} + 2\mathbf{k}$.
- 4** Write a vector equation for the plane that contains the point A, position vector $\begin{pmatrix} 2 \\ 1 \\ -3 \end{pmatrix}$, and that is perpendicular to the vector $\begin{pmatrix} 5 \\ 1 \\ 3 \end{pmatrix}$.
- 5** Write a vector equation for the plane that contains the point A, $2\mathbf{i} + 3\mathbf{j} - 2\mathbf{k}$, and that is parallel to the vectors $2\mathbf{i} + \mathbf{j}$ and $3\mathbf{i} - 4\mathbf{j} + 6\mathbf{k}$.
- 6** Write a vector equation for the plane that contains the point A, $\begin{pmatrix} -3 \\ 2 \\ -1 \end{pmatrix}$, and that is parallel to the vectors $\begin{pmatrix} 2 \\ 0 \\ -3 \end{pmatrix}$ and $\begin{pmatrix} 1 \\ -3 \\ 2 \end{pmatrix}$.
- 7** The point with position vector $a\mathbf{i} + 7\mathbf{j} + 5\mathbf{k}$ lies on the line with vector equation $\mathbf{r} = 2\mathbf{i} + b\mathbf{j} - \mathbf{k} + \lambda(-3\mathbf{i} + \mathbf{j} + 2\mathbf{k})$.
- Determine the values of the constants a and b .
- 8** Write the cartesian equation of the plane with vector equation $\mathbf{r} \cdot \begin{pmatrix} 3 \\ 2 \\ -1 \end{pmatrix} = 21$.
- 9** State the vector equation $\mathbf{r} \cdot \mathbf{n} = c$ for the plane with cartesian equation $2x - 3y + 7z = 5$
- 10** Prove that the line $\mathbf{r} = 2\mathbf{i} + 8\mathbf{j} - 3\mathbf{k} + \lambda(-6\mathbf{i} - 4\mathbf{j} + 2\mathbf{k})$ is perpendicular to the plane $\mathbf{r} \cdot (3\mathbf{i} + 2\mathbf{j} - \mathbf{k}) = c$.

11 Show that the lines $L_1: \mathbf{r} = \begin{pmatrix} 10 \\ 5 \\ -2 \end{pmatrix} + \lambda \begin{pmatrix} 4 \\ 1 \\ -2 \end{pmatrix}$ and $L_2: \mathbf{r} = \begin{pmatrix} 0 \\ 8 \\ -6 \end{pmatrix} + \mu \begin{pmatrix} -1 \\ -3 \\ 5 \end{pmatrix}$ intersect and find the position vector of this point of intersection.

12 Show that the lines $L_1: \mathbf{r} = \mathbf{i} - 2\mathbf{j} + 3\mathbf{k} + \lambda(-\mathbf{i} + 3\mathbf{j} + 2\mathbf{k})$ and $L_2: \mathbf{r} = 3\mathbf{i} + 13\mathbf{j} - 15\mathbf{k} + \mu(-\mathbf{i} + 4\mathbf{k})$ intersect and find the position vector of this point of intersection.

13 Line L_1 has equation: $\mathbf{r} = 13\mathbf{i} + \mathbf{j} + 8\mathbf{k} + \lambda(2\mathbf{i} - \mathbf{j} + 3\mathbf{k})$.
 Line L_2 has equation: $\mathbf{r} = 12\mathbf{i} + 2\mathbf{j} + 6\mathbf{k} + \mu(5\mathbf{i} + 3\mathbf{j} - 8\mathbf{k})$.
 Line L_3 has equation: $\mathbf{r} = -5\mathbf{i} + 2\mathbf{j} - 3\mathbf{k} + \beta(2\mathbf{i} + \mathbf{j} - \mathbf{k})$.

- a** Prove that lines L_1 and L_2 do not intersect.
- b** Prove that lines L_1 and L_3 intersect, find the position vector of the point of intersection and determine the angle between the lines.

14 Line L has vector equation: $\mathbf{r} = \mathbf{i} - 2\mathbf{j} + 5\mathbf{k} + \lambda(5\mathbf{i} + 3\mathbf{j} - 2\mathbf{k})$
 Plane Π has vector equation: $\mathbf{r} \cdot (-\mathbf{i} + 3\mathbf{j} + 2\mathbf{k}) = 3$

- a** Show that point A, position vector $-4\mathbf{i} - 5\mathbf{j} + 7\mathbf{k}$, lies on L .
- b** Show that point B, position vector $10\mathbf{i} + 3\mathbf{j} + 2\mathbf{k}$, does not lie on L .
- c** Show that points A and B both lie in the plane Π .
- d** Show that line L lies in the plane Π .

15 At time $t = 0$ the position vectors (\mathbf{r} m) and velocity vectors (\mathbf{v} m/sec) of two particles A and B are as follows:

$$\mathbf{r}_A = \begin{pmatrix} -10 \\ 20 \\ -12 \end{pmatrix} \quad \mathbf{v}_A = \begin{pmatrix} 5 \\ -10 \\ 6 \end{pmatrix} \quad \mathbf{r}_B = \begin{pmatrix} -3 \\ -8 \\ 2 \end{pmatrix} \quad \mathbf{v}_B = \begin{pmatrix} 4 \\ -6 \\ 4 \end{pmatrix}$$

Show that if the particles continue with these velocities they will collide and find the time of collision and the position vector of its location.

16 Find, in the form $\mathbf{r} = \mathbf{a} + \lambda\mathbf{b} + \mu\mathbf{c}$, the vector equation of the plane containing the line

$$\mathbf{r} = \begin{pmatrix} 2 \\ 2 \\ 1 \end{pmatrix} + \lambda \begin{pmatrix} 1 \\ -3 \\ -5 \end{pmatrix} \text{ and the point } \begin{pmatrix} 1 \\ 2 \\ 0 \end{pmatrix}.$$

Find the cartesian equation of this plane.

Hence express the equation of the plane in the form $\mathbf{r} \cdot \mathbf{n} = c$.



- 17** Find the position vector of the point where the line

$$\mathbf{r} = 2\mathbf{i} + 13\mathbf{j} + \mathbf{k} + \lambda(-\mathbf{i} + 3\mathbf{j} - 2\mathbf{k})$$

meets the plane

$$\mathbf{r} \cdot (2\mathbf{i} - \mathbf{j} - \mathbf{k}) = 11$$

- 18** Relative to a tracking station situated in space, the position vectors (\mathbf{r} km) and velocity vectors (\mathbf{v} km/h) of a spacecraft and of a piece of space debris at time $t = 0$ hours were as given below.

$$\mathbf{r}_{\text{debris}} = 1200\mathbf{i} + 3000\mathbf{j} + 900\mathbf{k},$$

$$\mathbf{v}_{\text{debris}} = 2000\mathbf{i} - 3600\mathbf{j} + 1000\mathbf{k}.$$

$$\mathbf{r}_{\text{spacecraft}} = 5750\mathbf{i} - 13\,250\mathbf{j} + 3370\mathbf{k},$$

$$\mathbf{v}_{\text{spacecraft}} = 600\mathbf{i} + 1400\mathbf{j} + 240\mathbf{k}.$$

Prove that if these velocities are maintained the spacecraft and the space debris will collide, and find the value of t for which this collision occurs.

- 19** A military fighter plane A wishes to intercept a supply plane B for mid-air refuelling. When the fighter pilot receives instructions to immediately change course and intercept B his position vector is $(80\mathbf{i} + 400\mathbf{j} + 3\mathbf{k})$ km. At that time B has position vector $(150\mathbf{i} + 470\mathbf{j} + 2\mathbf{k})$ km and is maintaining a constant velocity of $(300\mathbf{i} + 180\mathbf{j})$ km/h.

If the interception occurs 10 minutes later find the constant velocity maintained by the fighter during these ten minutes. (Ignore the final slow down necessary for smooth interception.)



Shutterstock.com/leonP

- 20** Plane Π_1 has equation $\mathbf{r} \cdot \begin{pmatrix} 2 \\ -2 \\ 1 \end{pmatrix} = 12$.

Plane Π_2 has equation $\mathbf{r} \cdot \begin{pmatrix} -2 \\ 2 \\ -1 \end{pmatrix} = 15$.

a Prove that Π_1 and Π_2 are parallel planes.

b Find the distance the planes are apart.

- 21** At time $t = 0$ (seconds) the position vectors (\mathbf{r} m) and velocity vectors (\mathbf{v} m/s) of two particles A and B are as follows:

$$\mathbf{r}_A = \begin{pmatrix} 30 \\ -37 \\ -30 \end{pmatrix} \quad \mathbf{v}_A = \begin{pmatrix} 5 \\ 8 \\ 3 \end{pmatrix} \quad \mathbf{r}_B = \begin{pmatrix} 2 \\ 40 \\ 26 \end{pmatrix} \quad \mathbf{v}_B = \begin{pmatrix} 8 \\ 0 \\ -2 \end{pmatrix}$$

Assuming that the particles continue with these velocities find the minimum separation distance between the particles in the subsequent motion and the value of t for which it occurs.

Vector equation of a sphere

If we extend our understanding of the equation of a circle in the x - y plane to three-dimensional space we obtain the equation of a sphere.

In three dimensions all points situated a distance a from some fixed point will form a sphere of radius a , centre at the fixed point.

The vector equation of a sphere centre $(0, 0, 0)$ and radius a is:

$$|\mathbf{r}| = a.$$

Writing \mathbf{r} as $x\mathbf{i} + y\mathbf{j} + z\mathbf{k}$ we obtain the cartesian equation:

$$x^2 + y^2 + z^2 = a^2.$$

If the radius of the sphere is a and the centre has position vector \mathbf{d} then the equation of the sphere is:

$$|\mathbf{r} - \mathbf{d}| = a.$$

Writing \mathbf{r} as $x\mathbf{i} + y\mathbf{j} + z\mathbf{k}$ and \mathbf{d} as $p\mathbf{i} + q\mathbf{j} + r\mathbf{k}$ we obtain the cartesian equation:

$$(x - p)^2 + (y - q)^2 + (z - r)^2 = a^2.$$

EXAMPLE 13

Find the centre, radius and vector equation of the sphere with Cartesian equation

$$x^2 + y^2 + z^2 = 6 - 2x + 4y + 10z.$$

Solution

Given

$$x^2 + y^2 + z^2 = 6 - 2x + 4y + 10z$$

i.e.

$$x^2 + 2x + y^2 - 4y + z^2 - 10z = 6$$

Create gaps:

$$x^2 + 2x + y^2 - 4y + z^2 - 10z = 6$$

Complete the squares:

$$x^2 + 2x + 1 + y^2 - 4y + 4 + z^2 - 10z + 25 = 6 + 1 + 4 + 25$$

Hence

$$(x + 1)^2 + (y - 2)^2 + (z - 5)^2 = 36$$

The sphere has its centre at $(-1, 2, 5)$,
a radius of 6 units

and vector equation $|\mathbf{r} - (-\mathbf{i} + 2\mathbf{j} + 5\mathbf{k})| = 6$.



EXAMPLE 14

Find the position vectors of the points where the line $\mathbf{r} = \mathbf{i} - \mathbf{j} + 2\mathbf{k} + \lambda(2\mathbf{i} + 9\mathbf{j})$ cuts the sphere $|\mathbf{r} - (\mathbf{i} + 2\mathbf{j} - \mathbf{k})| = 7$.

Solution

If point A lies on the line and the sphere then $\mathbf{r}_A = \mathbf{i} - \mathbf{j} + 2\mathbf{k} + \lambda(2\mathbf{i} + 9\mathbf{j})$

and $|\mathbf{r}_A - (\mathbf{i} + 2\mathbf{j} - \mathbf{k})| = 7$

Thus $|\mathbf{i} - \mathbf{j} + 2\mathbf{k} + \lambda(2\mathbf{i} + 9\mathbf{j}) - (\mathbf{i} + 2\mathbf{j} - \mathbf{k})| = 7$

i.e. $|2\lambda\mathbf{i} + (9\lambda - 3)\mathbf{j} + 3\mathbf{k}| = 7$

$\therefore 4\lambda^2 + 81\lambda^2 - 54\lambda + 9 + 9 = 49$

giving $85\lambda^2 - 54\lambda - 31 = 0$

Thus $\lambda = 1$ or $\lambda = -\frac{31}{85}$

Substituting these values into the equation of the given line gives the required position vectors as $3\mathbf{i} + 8\mathbf{j} + 2\mathbf{k}$ and $\frac{1}{85}(23\mathbf{i} - 364\mathbf{j} + 170\mathbf{k})$.

Exercise 5D

Find the centre and radius of each of the following spheres.

1 $|\mathbf{r}| = 16$

2 $x^2 + y^2 + z^2 = 100$

3 $|\mathbf{r} - (\mathbf{i} + \mathbf{j} + \mathbf{k})| = 25$

4 $|\mathbf{r} - 2\mathbf{i} + 3\mathbf{j} - 4\mathbf{k}| = 18$

5 $(x - 3)^2 + (y + 1)^2 + (z - 2)^2 = 10$

6 $(x + 4)^2 + (y - 1)^2 + z^2 = 25$

7 $x^2 + y^2 - 8y + 16 + z^2 = 50$

8 $x^2 + y^2 + z^2 - 2x + 6y = 15$

9 $x^2 + y^2 + z^2 - 6y + 2z = 111$

10 $x^2 + y^2 + z^2 + 8x - 2y + 2z = 7$

For questions 11 to 18 state whether the given point lies inside, on or outside the sphere.

11 $|\mathbf{r}| = 5$, $(2, -3, 4)$.

12 $|\mathbf{r}| = 7$, $(-2, 3, 6)$.

13 $|\mathbf{r}| = 16$, $(7, 12, 9)$.

14 $|\mathbf{r} - (\mathbf{i} + \mathbf{j} - \mathbf{k})| = 8$, $(3, 1, 0)$.

15 $|\mathbf{r} - (2\mathbf{i} - \mathbf{j} + 3\mathbf{k})| = 5$, $(3, 5, 2)$.

16 $|\mathbf{r} - (7\mathbf{i} + 10\mathbf{j} + 2\mathbf{k})| = 13$, $(2, -2, 2)$.

17 $(x - 1)^2 + (y + 3)^2 + (z - 2)^2 = 36$, $(5, -6, -1)$.

18 $x^2 + y^2 + z^2 - 4x - 3y - z = 61$, $(-1, 0, 8)$.

- 19** A, B and C have position vectors $a\mathbf{i} + 5\mathbf{j} + 2\mathbf{k}$, $-4\mathbf{i} + b\mathbf{j} - 3\mathbf{k}$ and $2\mathbf{i} + \mathbf{j} + c\mathbf{k}$, respectively. All three points lie on the sphere $|\mathbf{r} - (\mathbf{i} + \mathbf{j} - 3\mathbf{k})| = 5\sqrt{2}$. Find the values of a , b and c given that they are all positive constants.

- 20** Find the position vectors of points where the line $\mathbf{r} = \begin{pmatrix} -2 \\ 16 \\ -1 \end{pmatrix} + \lambda \begin{pmatrix} -2 \\ 5 \\ -2 \end{pmatrix}$ cuts the sphere $\left| \mathbf{r} - \begin{pmatrix} 1 \\ -1 \\ 3 \end{pmatrix} \right| = 5\sqrt{2}$.

- 21** Find the position vectors of points where the line $\mathbf{r} = 14\mathbf{i} - 9\mathbf{k} + \lambda(4\mathbf{i} + \mathbf{j} - 9\mathbf{k})$ cuts the sphere $|\mathbf{r} - (4\mathbf{i} + \mathbf{j} + 3\mathbf{k})| = 7$.

- 22** Prove that the line $\mathbf{r} = -2\mathbf{i} - \mathbf{j} - 11\mathbf{k} + \lambda(3\mathbf{i} + 4\mathbf{k})$ touches but does not cut the sphere $|\mathbf{r} - (3\mathbf{i} - \mathbf{j} + 4\mathbf{k})| = 5$. (i.e. Prove the line is a tangent to the sphere.) Find the position vector of the point of contact.

- 23** Prove that the line $\mathbf{r} = \begin{pmatrix} 9 \\ 18 \\ 20 \end{pmatrix} + \lambda \begin{pmatrix} -1 \\ -4 \\ -3 \end{pmatrix}$ is a tangent to the sphere $\left| \mathbf{r} - \begin{pmatrix} -2 \\ 1 \\ 3 \end{pmatrix} \right| = 7$ and find the position vector of the point of contact.



iStock.com/pawopa3336



Distance from a point to a line revisited

Note

This section uses the fact that $|\mathbf{a} \times \mathbf{b}| = |\mathbf{a}||\mathbf{b}| \sin \theta$.

At the time of writing, this application of the vector product is not specifically mentioned in the syllabus so it could be argued that such consideration is beyond the requirements of the unit. I include the use of the fact here to find the distance from a point to a line. The inclusion is for completeness, for interest, and in case that at some later stage it is made explicit that the inclusion of the cross product in the syllabus is to be taken as including the use of the above fact.

In the previous chapter, when considering vectors in the \mathbf{i} - \mathbf{j} plane, we used the scalar product to determine the distance from point A to a line L.

The method used the fact that $\mathbf{q} \cdot \overrightarrow{AP} = 0$. (See diagram, right.)

We can similarly use a scalar product approach to find the distance from a point to a line in three-dimensional space, as *Method one* of the next example shows. However, now that we have met the concept of a vector product of two vectors, and in particular that $|\mathbf{a} \times \mathbf{b}| = |\mathbf{a}||\mathbf{b}| \sin \theta$, we could also use a vector product approach to find the distance from a point to a line, as *Method two* of the next example shows.

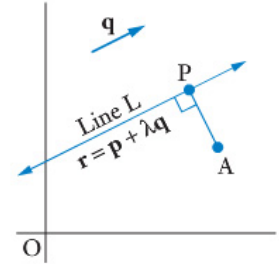

EXAMPLE 15

Find the distance from the point A, position vector $3\mathbf{i} - \mathbf{j} + 2\mathbf{k}$, to a line passing through points B and C, position vectors $2\mathbf{i} + 3\mathbf{j} - \mathbf{k}$ and $\mathbf{i} - \mathbf{j} + \mathbf{k}$ respectively.

Solution

Method one: A scalar product approach

A sketch of the situation is shown on the right. (This sketch does not need any accurate portrayal of relative positions. It simply allows us to formulate our method.)

We require the distance d shown in the diagram.

We will use the fact that $\overrightarrow{BC} \cdot \overrightarrow{AD} = 0$.

$$\overrightarrow{BC} = -\begin{pmatrix} 2 \\ 3 \\ -1 \end{pmatrix} + \begin{pmatrix} 1 \\ -1 \\ 1 \end{pmatrix} = \begin{pmatrix} -1 \\ -4 \\ 2 \end{pmatrix}$$

$$\begin{aligned} \overrightarrow{AD} &= -\begin{pmatrix} 3 \\ -1 \\ 2 \end{pmatrix} + \begin{pmatrix} 2 \\ 3 \\ -1 \end{pmatrix} + \lambda \overrightarrow{BC} \\ &= \begin{pmatrix} -1 - \lambda \\ 4 - 4\lambda \\ -3 + 2\lambda \end{pmatrix} \end{aligned}$$

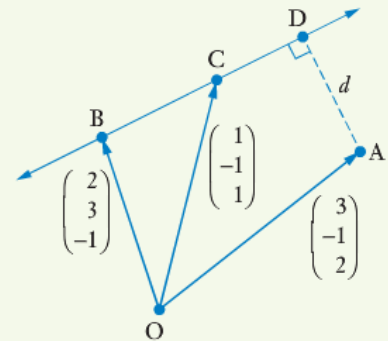

Thus
$$\begin{pmatrix} -1 \\ -4 \\ 2 \end{pmatrix} \cdot \begin{pmatrix} -1-\lambda \\ 4-4\lambda \\ -3+2\lambda \end{pmatrix} = 0$$

Solving gives
$$\lambda = 1$$

Thus
$$\vec{AD} = \begin{pmatrix} -2 \\ 0 \\ -1 \end{pmatrix}$$

and hence
$$d = \sqrt{5} \text{ units of length.}$$

Method two: A vector product approach

Required distance
$$\begin{aligned} &= |\vec{CA}| \sin \theta \\ &= (|\vec{BC}| |\vec{CA}| \sin \theta) \div |\vec{BC}| \\ &= |\vec{BC} \times \vec{CA}| \div |\vec{BC}| \end{aligned}$$

Now
$$\vec{BC} = -\mathbf{i} - 4\mathbf{j} + 2\mathbf{k}$$

and
$$\vec{CA} = 2\mathbf{i} + 0\mathbf{j} + \mathbf{k}$$

Thus
$$\vec{BC} \times \vec{CA} = -4\mathbf{i} + 5\mathbf{j} + 8\mathbf{k}$$

$$\begin{aligned} |\vec{BC} \times \vec{CA}| \div |\vec{BC}| &= \sqrt{105} \div \sqrt{21} \\ &= \sqrt{5}, \quad \text{as in Method one.} \end{aligned}$$

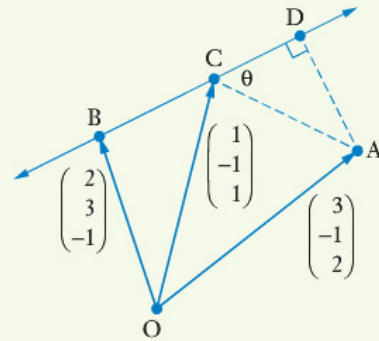

Exercise 5E

For each of the following find the distance the given point is from the given line, in each case calculating the distance twice, once using a scalar product approach and once using a vector product approach.

- 1** Given point: Point A, position vector $\mathbf{i} + \mathbf{j} + \mathbf{k}$.
 Given line: Line through points B, position vector $2\mathbf{i} - \mathbf{j} + 2\mathbf{k}$,
 and C, position vector $3\mathbf{i} + \mathbf{j} - \mathbf{k}$.

- 2** Given point: Point A, position vector $4\mathbf{i} - 2\mathbf{j} + 3\mathbf{k}$.
 Given line: Line through points B, position vector $2\mathbf{i} + \mathbf{j} - 3\mathbf{k}$,
 and C, position vector $3\mathbf{i} - \mathbf{j} + 2\mathbf{k}$.

- 3** Given point: Point A, position vector $\mathbf{i} + 2\mathbf{j} + \mathbf{k}$.
 Given line: Line $\mathbf{r} = 2\mathbf{i} + 3\mathbf{k} + \lambda(\mathbf{i} - 3\mathbf{j} + 4\mathbf{k})$.



Miscellaneous exercise five

This miscellaneous exercise may include questions involving the work of this chapter, the work of any previous chapters, and the ideas mentioned in the Preliminary work section at the beginning of the book.

1 Suppose $f(x) = 3x - 2$ and $g(x) = f(|x|)$.

Find **a** $f(3)$

b $f(-3)$

c $g(3)$

d $g(-3)$

e $f(5)$

f $g(-5)$

g Draw the graphs of $y = f(x)$ and $y = g(x)$.

2 AB is a diameter of a circle, lying in the \mathbf{i} - \mathbf{j} plane, with its centre at point P.

If point A has coordinates (1, 2) and B has coordinates (9, -4) find

a the coordinates of point P,

b the radius of the circle,

c the vector equation of the circle.

3 Find the radius and the cartesian coordinates of the centre of the following circles, each lying in the \mathbf{i} - \mathbf{j} plane.

a $|\mathbf{r} - (3\mathbf{i} - 2\mathbf{j})| = 7$

b $|\mathbf{r} - 2\mathbf{i} - 7\mathbf{j}| = 11$

c $(x - 3)^2 + (y + 2)^2 = 16$.

d $(x + 1)^2 + (y + 7)^2 = 20$.

e $x^2 + y^2 - 8x = 4y + 5$.

f $x^2 + 6x + y^2 - 14y = 42$.

4 Find to the nearest degree the acute angle between the lines L_1 and L_2 if L_1 has equation $\mathbf{r} = 2\mathbf{i} + \mathbf{j} + \lambda(3\mathbf{i} - \mathbf{j})$ and L_2 has equation $\mathbf{r} = 3\mathbf{i} - \mathbf{j} + \mu(2\mathbf{i} + 3\mathbf{j})$.

5 Find the range of each of the following for domain \mathbb{R} .

a $f(x) = x^2$

b $f(x) = x^2 + 3$

c $f(x) = (x + 3)^2$

d $f(x) = |x|$

e $f(x) = |x| + 3$

f $f(x) = |x + 3|$

6 What restriction is there on the possible values of a if

$$x^2 + 2x + y^2 - 10y + a = 0$$

is the equation of a circle?

7 If $f(x) = \frac{3}{x}$ and $g(x) = 2x - 1$ find the functions $f \circ g(x)$ and $g \circ f(x)$ in terms of x and state the natural domain and range of each.

8 Repeat the previous question but now for $f(x) = \sqrt{x + 3}$ and $g(x) = x^2 + 1$.



9 If $z = 8 \operatorname{cis}\left(\frac{\pi}{6}\right)$, and \bar{z} is the complex conjugate of z , determine each of the following, giving your answers in the form $r \operatorname{cis} \theta$ for $r \geq 0$ and $-\pi < \theta \leq \pi$.

- a** \bar{z} **b** $z + \bar{z}$ **c** $z - \bar{z}$ **d** $z \bar{z}$ **e** $z + \bar{z}$

10 For $\{z: |z - (4 + 4i)| = 3\}$ determine

- a** the minimum possible value of $\operatorname{Im}(z)$.
b the maximum possible value of $\operatorname{Re}(z)$.
c the minimum possible value of $|z|$.
d the maximum possible value of $|z|$.
e the maximum possible value of $|\bar{z}|$.

11 (Without the assistance of a calculator.)

If $z = 3 \operatorname{cis}\left(\frac{5\pi}{6}\right)$ and $w = 2 \operatorname{cis}\left(-\frac{2\pi}{3}\right)$ express each of the following in the form

$r \operatorname{cis} \theta$ for $r > 0$ and $-\pi < \theta \leq \pi$.

- a** $2z$ **b** $3w$ **c** zw **d** $\frac{z}{w}$ **e** iz
f $-w$ **g** \bar{z} **h** \overline{zw} **i** $\bar{z}\bar{w}$ **j** z^2w^3

12 (Without the assistance of a calculator.)

Display the three solutions to the equation $z^3 = \frac{27}{i}$ on an Argand diagram and express each in the form $r \operatorname{cis} \theta$ with $r \geq 0$ and $-\pi < \theta \leq \pi$.

13 (Without the assistance of a calculator.)

If $z = -1 + \sqrt{3}i$ and \bar{z} is the complex conjugate of z express

$$\left(z + \frac{1}{\bar{z}}\right)^4 \text{ and } \left(z - \frac{1}{\bar{z}}\right)^4$$

in the form $r \operatorname{cis} \theta$ for $-\pi \leq \theta \leq \pi$.

14 For each of the following conditions show diagrammatically the set of all points lying in the complex plane and obeying the condition.

- a** $z + \bar{z} = 4$ **b** $|z - i| = 2$ **c** $0 \leq \arg(z - 2) \leq \frac{2\pi}{3}$

15 The line $\mathbf{r} = (2\mathbf{i} + 3\mathbf{j} - \mathbf{k}) + \lambda(-\mathbf{i} + 3\mathbf{j} + \mathbf{k})$ passes through A (where $\lambda = 1$) and B (where $\lambda = 5$). Find the position vector of point C where $\overrightarrow{AC} : \overrightarrow{BA} = -1 : 4$.



- 16** Each part of this question gives the vector equations of two lines.

For each part determine whether the lines are parallel lines,
or intersecting lines,
or skew lines.

a $\mathbf{r} = 3\mathbf{i} + \mathbf{j} - 2\mathbf{k} + \lambda(3\mathbf{i} - 2\mathbf{j} + \mathbf{k})$

and $\mathbf{r} = 5\mathbf{j} + 2\mathbf{k} + \mu(6\mathbf{i} - 4\mathbf{j} + 2\mathbf{k})$

b $\mathbf{r} = 2\mathbf{i} + 3\mathbf{j} + 10\mathbf{k} + \lambda(-\mathbf{i} + 3\mathbf{j} + \mathbf{k})$

and $\mathbf{r} = -5\mathbf{i} + 3\mathbf{j} - 5\mathbf{k} + \mu(2\mathbf{i} + \mathbf{j} + 2\mathbf{k})$

c $\mathbf{r} = -\mathbf{i} + 5\mathbf{j} + \lambda(-\mathbf{i} + \mathbf{j} + \mathbf{k})$

and $\mathbf{r} = 2\mathbf{j} - 7\mathbf{k} + \mu(\mathbf{i} + 2\mathbf{k})$

d $\mathbf{r} = 7\mathbf{i} + 2\mathbf{j} - 3\mathbf{k} + \lambda(\mathbf{i} + \mathbf{j} - \mathbf{k})$

and $\mathbf{r} = 5\mathbf{i} + 6\mathbf{j} + \mu(-\mathbf{i} - \mathbf{j} + \mathbf{k})$

- 17** At time $t = 0$ seconds the position vectors, \mathbf{r} , and velocity vectors, \mathbf{v} , of a tanker and a submarine are as follows. (The \mathbf{i} - \mathbf{j} plane is the surface of the sea.)

$$\mathbf{r}_{\text{Tanker}} = (1150\mathbf{i} + 827\mathbf{j}) \text{ m}$$

$$\mathbf{r}_{\text{Sub}} = (1345\mathbf{i} + 970\mathbf{j}) \text{ m}$$

$$\mathbf{v}_{\text{Tanker}} = (10\mathbf{i} - 2\mathbf{j}) \text{ m/s}$$

$$\mathbf{v}_{\text{Sub}} = (-5\mathbf{i} - 13\mathbf{j} - 4\mathbf{k}) \text{ m/s}$$

If both vessels maintain these velocities, show that the tanker passes directly over the submarine, find the value of t when this occurs and find the depth of the submarine at the time.

- 18** Use vector methods to prove that in the parallelogram OABC the line drawn from O to the mid-point of AB cuts AC at the point of trisection of AC that is nearer to A.

- 19** A defensive missile battery launches a ground-to-air missile A to intercept an incoming enemy missile B. At the moment of A's launch the position vectors of A and B (in metres), relative to the defensive command headquarters were:

$$\mathbf{r}_A = \begin{pmatrix} 600 \\ 0 \\ 0 \end{pmatrix} \quad \text{and} \quad \mathbf{r}_B = \begin{pmatrix} 2200 \\ 4000 \\ 600 \end{pmatrix}$$

A and B maintain the velocities (in m/s): $\mathbf{v}_A = \begin{pmatrix} -196 \\ 213 \\ 18 \end{pmatrix}$ and $\mathbf{v}_B = \begin{pmatrix} -240 \\ 100 \\ 0 \end{pmatrix}$

Prove that A will *not* intercept B and find 'how much it misses by'.

Suppose instead that the computer on missile A detects that it is off target and, 20 seconds into its flight, A changes its velocity and interception occurs after a further 15 seconds. Find, in the form $a\mathbf{i} + b\mathbf{j} + c\mathbf{k}$, the constant velocity that A must maintain during this final 15 seconds for the interception to occur.



6.

Systems of linear equations

- Systems of equations
- A systematic algebraic approach for solving systems of linear equations using a matrix form of presentation (and otherwise)
- Calculators and row echelon form
- Systems of linear equations having no solution
- Systems of linear equations having infinitely many solutions
- Miscellaneous exercise six

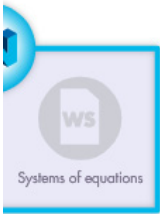

Systems of equations

Did you manage to solve the systems of linear equations obtained from the previous situations by applying the elimination technique you are probably familiar with as a means of solving two equations in two unknowns? In this method we use the equations ‘against each other’ to eliminate one of the variables.

For example, for a system involving two linear equations:

$$\begin{array}{rcl} & x + y & = 11 & [1] \\ & 3x + 2y & = 26 & [2] \\ \\ \text{Equation [1]} \times 3 & 3x + 3y & = 33 & \\ \text{Equation [2]} & 3x + 2y & = 26 & \\ \text{Subtraction eliminates } x: & & y = 7 & \\ \text{Substitution back into Equation [1] gives} & x + 7 & = 11 & \\ \therefore & & x = 4 & \end{array}$$

This same elimination technique can be used for 3 equations involving three unknowns, as shown below.

$$\begin{array}{rcl} \text{Consider the three equations:} & \left\{ \begin{array}{l} x + 2y - 3z = 9 & [1] \\ 2x - y + z = 0 & [2] \\ -3x + 4y - 2z = 12 & [3] \end{array} \right. & \\ \\ \text{Equation [1]} \times 2 & 2x + 4y - 6z = 18 & \\ \text{Equation [2]} & 2x - y + z = 0 & \\ \text{Subtraction eliminates } x: & & 5y - 7z = 18 & [4] \\ \\ \text{Equation [1]} \times 3 & 3x + 6y - 9z = 27 & \\ \text{Equation [3]} & -3x + 4y - 2z = 12 & \\ \text{Addition eliminates } x: & & 10y - 11z = 39 & [5] \\ \\ \text{Equation [4]} \times 2 & 10y - 14z = 36 & \\ \text{Equation [5]} & 10y - 11z = 39 & \\ \text{Subtraction eliminates } y: & & -3z = -3 & \\ \therefore & & z = 1 & \\ \text{Substitution back into equation [4] gives} & & y = 5 & \\ \text{Substitution back into equation [1] gives} & & x = 2 & \end{array}$$

Thus $x = 2$, $y = 5$ and $z = 1$.

Thus by using the equations ‘against each other’ to systematically eliminate variables until we are left with one equation in one unknown, systems of three equations involving three unknowns can be solved, provided of course that a solution exists.

Alternatively we could use the ability of some calculators to solve systems of equations like this.



Note • For the system
$$\begin{cases} x + 2y - 3z = 9 \\ 2x - y + z = 0 \\ -3x + 4y - 2z = 12 \end{cases}$$
 the **matrix of coefficients**, or

coefficient matrix is
$$\begin{bmatrix} 1 & 2 & -3 \\ 2 & -1 & 1 \\ -3 & 4 & -2 \end{bmatrix}$$

This coefficient matrix has 3 rows and 3 columns.

From the coverage of Matrices in *Mathematics Specialist Unit Two* the reader should be aware that the above system of equations could be expressed in ‘matrix form’, and the inverse of the *coefficient matrix* used to determine a solution (as the *Preliminary Work* section at the beginning of this book reminded us). However, that is not the method explored here.

- If we enlarge the matrix to include the right hand side of each equation we have the **augmented matrix**:
$$\begin{bmatrix} 1 & 2 & -3 & 9 \\ 2 & -1 & 1 & 0 \\ -3 & 4 & -2 & 12 \end{bmatrix}$$

(The word *augment* means to increase or enlarge.)
This augmented matrix has 3 rows and 4 columns.

- The augmented matrix is sometimes shown with a vertical line separating the two parts of the matrix, as shown on the right.
$$\begin{bmatrix} 1 & 2 & -3 & | & 9 \\ 2 & -1 & 1 & | & 0 \\ -3 & 4 & -2 & | & 12 \end{bmatrix}$$

- To solve the system of equations we manipulate the rows until the coefficient matrix shows only zeros below the leading diagonal.

i.e. until the augmented matrix is of the form:

$$\begin{bmatrix} \# & \# & \# & | & \# \\ 0 & \# & \# & | & \# \\ 0 & 0 & \# & | & \# \end{bmatrix}$$

Notice the zeros below the ‘dotted line step formation’ in the above matrix. In this form the augmented matrix is said to be in **row echelon** form, the word *echelon* coming from its military use for a battle formation sometimes used by soldiers or warships. (A matrix is in echelon form when any rows in which all elements are zero occur at the bottom of the matrix and, as we move down the other rows, the first non zero elements in successive rows move right.)

The following matrices are all in echelon form:

$$\begin{bmatrix} 3 & 5 \\ 0 & -2 \end{bmatrix} \quad \begin{bmatrix} 3 & -4 & 1 \\ 0 & 2 & -3 \\ 0 & 0 & 5 \end{bmatrix} \quad \begin{bmatrix} 2 & 3 & 1 & -3 \\ 0 & 2 & -3 & 5 \\ 0 & 0 & 2 & -10 \end{bmatrix} \quad \begin{bmatrix} 2 & 3 & 1 & -3 \\ 0 & 0 & 1 & 2 \\ 0 & 0 & 0 & 0 \end{bmatrix}$$

- By interpreting the operations we might carry out in the elimination method, as operations on the rows of the augmented matrix, we obtain the following **elementary row operations** that we can use:
 - Interchanging rows.
 - Multiplying a row by a non-zero constant.
 - Adding a multiple of one row to a multiple of another row.



EXAMPLE 1 Solution using augmented matrix

Solve the system of linear equations, shown right.

$$\begin{aligned} 2x + y - 2z &= 11 \\ x + 2y - 3z &= 17 \\ -3x - y + 4z &= -21 \end{aligned}$$

Solution

First write the Augmented matrix:

$$\begin{array}{l} r_1 \\ r_2 \\ r_3 \end{array} \left[\begin{array}{cccc} 2 & 1 & -2 & 11 \\ 1 & 2 & -3 & 17 \\ -3 & -1 & 4 & -21 \end{array} \right]$$

Switch rows 1 and 2 to make first element of first row a 1:

$$\begin{array}{l} r_2 \\ r_1 \\ r_3 \end{array} \left[\begin{array}{cccc} 1 & 2 & -3 & 17 \\ 2 & 1 & -2 & 11 \\ -3 & -1 & 4 & -21 \end{array} \right] \begin{array}{l} \leftarrow \text{new } r_1 \\ \leftarrow \text{new } r_2 \end{array}$$

Combine suitable multiples of first and second rows to make the first element of the second row zero (and similarly use the first and third rows to make the first element of the third row a zero).

$$\begin{array}{l} r_1 \\ r_2 - 2r_1 \\ r_3 + 3r_1 \end{array} \left[\begin{array}{cccc} 1 & 2 & -3 & 17 \\ 0 & -3 & 4 & -23 \\ 0 & 5 & -5 & 30 \end{array} \right] \begin{array}{l} \\ \leftarrow \text{new } r_2 \\ \leftarrow \text{new } r_3 \end{array}$$

Use new 2nd and 3rd rows to reduce 2nd element of row 3 to zero.

$$\begin{array}{l} r_1 \\ r_2 \\ 3r_3 + 5r_2 \end{array} \left[\begin{array}{cccc} 1 & 2 & -3 & 17 \\ 0 & -3 & 4 & -23 \\ 0 & 0 & 5 & -25 \end{array} \right] \begin{array}{l} \\ \\ \leftarrow \text{new } r_3 \end{array}$$

$$\begin{array}{l} \text{Row 3 now tells us that} \\ \text{Using this in row 2} \\ \text{And from row 1} \end{array} \begin{array}{l} 5z = -25, \\ -3y - 20 = -23, \\ x + 2 + 15 = 17, \end{array} \begin{array}{l} \text{thus } z = -5. \\ \text{thus } y = 1. \\ \text{thus } x = 0. \end{array}$$

Thus $x = 0$, $y = 1$ and $z = -5$.

Alternatively, if you prefer to deal with the equations themselves, rather than manipulate the augmented matrix, you could follow similar steps to arrive at the same solution. This alternative form of presentation is shown on the next page as 'Example 1 repeated'. In the examples that appear later in this chapter each example is shown solved using an augmented matrix approach and then repeated without using the augmented matrix. Each form of presentation involves the systematic elimination of variables until one equation in one unknown is reached.



EXAMPLE 1 REPEATED**Solution without using augmented matrix**

Solve the system of linear equations, shown right.

$$\begin{aligned} 2x + y - 2z &= 11 \\ x + 2y - 3z &= 17 \\ -3x - y + 4z &= -21 \end{aligned}$$
Solution

Given the three equations:

$$\begin{cases} 2x + y - 2z = 11 & [1] \\ x + 2y - 3z = 17 & [2] \\ 3x + y + 4z = -21 & [3] \end{cases}$$

Use equations [1] and [2] to eliminate x .

Equation [1] $2x + y - 2z = 11$
 Equation [2] $\times 2$ $2x + 4y - 6z = 34$
 Subtraction eliminates x : $-3y + 4z = -23$ [4]

Use equations [2] and [3] to eliminate x .

Equation [2] $\times 3$ $3x + 6y - 9z = 51$
 Equation [3] $-3x - y + 4z = -21$
 Addition eliminates x : $5y - 5z = 30$ [5]

Equation [4] $\times 5$ $-15y + 20z = -115$

Equation [5] $\times 3$ $15y - 15z = 90$

Addition eliminates y : $5z = -25$

$\therefore z = -5$

Substitution back into equation [4] gives $y = 1$

Substitution back into equation [1] gives $x = 0$

Thus $x = 0, y = 1$ and $z = -5$, as before.

EXAMPLE 2**Augmented matrix approach**

Solve the system of linear equations, shown right.

$$\begin{aligned} 2x + y + z &= 1 \\ 2y + z &= 1 \\ 3x + y - z &= 8 \end{aligned}$$
Solution

First write the Augmented matrix:

$$\begin{array}{l} r_1 \\ r_2 \\ r_3 \end{array} \left[\begin{array}{cccc} 2 & 1 & 1 & 1 \\ 0 & 2 & 1 & 1 \\ 3 & 1 & -1 & 8 \end{array} \right]$$

$$\begin{array}{l} r_1 \\ r_2 \\ 2r_3 - 3r_1 \end{array} \left[\begin{array}{cccc} 2 & 1 & 1 & 1 \\ 0 & 2 & 1 & 1 \\ 0 & -1 & -5 & 13 \end{array} \right] \leftarrow \text{new } r_3$$

$$\begin{array}{l} r_1 \\ r_2 \\ 2r_3 + r_2 \end{array} \left[\begin{array}{cccc} 2 & 1 & 1 & 1 \\ 0 & 2 & 1 & 1 \\ 0 & 0 & -9 & 27 \end{array} \right] \leftarrow \text{new } r_3$$

From which we can determine that $z = -3, y = 2$ and $x = 1$.

EXAMPLE 2 REPEATED**Solution without using augmented matrix**

Solve the following system of linear equations.

$$2x + y + z = 1$$

$$2y + z = 1$$

$$3x + y - z = 8$$

Solution

Given the three equations:

$$\begin{cases} 2x + y + z = 1 & [1] \\ 2y + z = 1 & [2] \\ 3x + y - z = 8 & [3] \end{cases}$$

Use equations [1] and [3] to eliminate x .

Equation [1] \times 3

$$6x + 3y + 3z = 3$$

Equation [3] \times 2

$$6x + 2y - 2z = 16$$

Subtraction eliminates x :

$$y + 5z = -13 \quad [4]$$

Use equations [2] and [4] to eliminate x .

Equation [2]

$$2y + z = 1$$

Equation [4] \times 2

$$2y + 10z = -26$$

Subtraction eliminates y :

$$-9z = 27$$

\therefore

$$z = -3$$

Substitution back into equation [4] gives

$$y = 2$$

Substitution back into equation [1] gives

$$x = 1$$

Thus $z = -3, y = 2$ and $x = 1$, as before.

It should be remembered that the purpose of reducing the augmented matrix to echelon form is to give one row in our matrix in which two of the variables have been eliminated. In some cases the numbers involved may enable this situation to be obtained quickly without reducing to echelon form. For example, consider the following augmented matrix:

$$\begin{array}{l} r_1 \\ r_2 \\ r_3 \end{array} \left[\begin{array}{cccc} 1 & 2 & 3 & 13 \\ 2 & 5 & 9 & 33 \\ 0 & 2 & -3 & -4 \end{array} \right]$$

$$\begin{array}{l} r_1 \\ r_2 - 2r_1 \\ r_3 \end{array} \left[\begin{array}{cccc} 1 & 2 & 3 & 13 \\ 0 & 1 & 3 & 7 \\ 0 & 2 & -3 & -4 \end{array} \right] \quad \leftarrow \text{new } r_2$$

Rather than aim for echelon form we could use 'new $r_3 = r_3 + r_2$ ' to produce a second zero in a row of the coefficient matrix.

$$\begin{array}{l} r_1 \\ r_2 \\ r_3 + r_2 \end{array} \left[\begin{array}{cccc} 1 & 2 & 3 & 13 \\ 0 & 1 & 3 & 7 \\ 0 & 3 & 0 & 3 \end{array} \right] \quad \leftarrow \text{new } r_3$$

Thus $3y = 3$ and hence $y = 1, z = 2$ and $x = 5$.

Exercise 6A

Each of the following shows an augmented matrix that has been reduced to echelon form by elementary row operations. In each case the original augmented matrix was for a system of 3 equations with the coefficients of the three variables x, y and z forming the first three columns respectively.

Find x, y and z in each case.

$$\mathbf{1} \left[\begin{array}{ccc|c} 1 & 0 & 0 & 3 \\ 0 & 1 & 0 & -2 \\ 0 & 0 & 1 & 5 \end{array} \right]$$

$$\mathbf{2} \left[\begin{array}{ccc|c} 1 & 0 & 0 & 4 \\ 0 & 1 & 0 & 7 \\ 0 & 0 & 1 & -2 \end{array} \right]$$

$$\mathbf{3} \left[\begin{array}{ccc|c} 2 & 1 & 1 & 4 \\ 0 & 2 & 5 & 15 \\ 0 & 0 & 1 & 1 \end{array} \right]$$

$$\mathbf{4} \left[\begin{array}{ccc|c} 1 & 0 & -2 & 7 \\ 0 & 3 & 2 & 6 \\ 0 & 0 & -1 & 3 \end{array} \right]$$

$$\mathbf{5} \left[\begin{array}{ccc|c} 1 & 3 & 2 & 27 \\ 0 & 5 & -3 & 2 \\ 0 & 0 & 2 & 12 \end{array} \right]$$

$$\mathbf{6} \left[\begin{array}{ccc|c} 2 & 1 & 1 & -3 \\ 0 & 3 & -2 & 0 \\ 0 & 0 & -3 & 9 \end{array} \right]$$

Write the augmented matrix for each of the following systems of equations.

$$\mathbf{7} \quad \begin{array}{l} 3x + 2y = 10 \\ x - 4y = 8 \end{array}$$

$$\mathbf{8} \quad \begin{array}{l} -x + 5y = 12 \\ 2x + 3y = 2 \end{array}$$

$$\mathbf{9} \quad \begin{array}{l} x + 4y + 3z = 18 \\ 3x + y + 2z = 11 \\ 5x + 2y + z = 12 \end{array}$$

$$\mathbf{10} \quad \begin{array}{l} 2x + 3z = 14 \\ 4x + y - z = 0 \\ 2x + y + 6z = 26 \end{array}$$

$$\mathbf{11} \quad \begin{array}{l} 3x + 2y = 8 \\ x + 2z = 8 \\ 2y - z = -1 \end{array}$$

$$\mathbf{12} \quad \begin{array}{l} x + 3y - 5z = 2 \\ 2x + y + 7z = 37 \\ -x + z = 3 \end{array}$$

Using an augmented matrix approach, or otherwise, solve each of the following systems of equations **without the assistance of the solve facility of a calculator**. Whichever method of presentation you choose, how you are combining rows or equations needs to be clearly stated. I.e. include in your working explanation like $r_2 - 2r_1$, or Equation $[1] \times 2$, etc.

(If you prefer to manipulate the equations rather than use the augmented matrix approach it is suggested that you at least do some of the questions using the matrix approach.)

$$\mathbf{13} \quad \begin{array}{l} x + 3y = 34 \\ 2x + 5y = 59 \end{array}$$

$$\mathbf{14} \quad \begin{array}{l} 2x + 3y = 4 \\ 4x + 9y = 2 \end{array}$$

$$\mathbf{15} \quad \begin{array}{l} x + 2y + z = 7 \\ y + 3z = 7 \\ 3x + 3y + z = 14 \end{array}$$

$$\mathbf{16} \quad \begin{array}{l} x + y + z = 6 \\ x + 2y + 4z = 6 \\ 2x + 3y - 3z = 20 \end{array}$$



$$\begin{aligned} 17 \quad & x + 4z = -1 \\ & 2x + y + 3z = 8 \\ & 5x + y = 35 \end{aligned}$$

$$\begin{aligned} 19 \quad & 2x + y = 11 \\ & x + 2y - z = 15 \\ & 3x + 9y + z = 16 \end{aligned}$$

$$\begin{aligned} 21 \quad & 3x + 4y + 5z = 14 \\ & 5x + 7y + 6z = 13 \\ & x + y + z = 3 \end{aligned}$$

$$\begin{aligned} 23 \quad & x + y + 2z = 6 \\ & 3x + 2y + z = 7 \\ & 5x + 4y + 4z = 19 \end{aligned}$$

$$\begin{aligned} 18 \quad & x + 2y - z = 3 \\ & 2x + 3y + 2z = -1 \\ & 3x + 7y - 2z = 6 \end{aligned}$$

$$\begin{aligned} 20 \quad & 2x + 4y - 3z = 1 \\ & 2x + 5y - 2z = 5 \\ & 3x + 7y - 3z = 7 \end{aligned}$$

$$\begin{aligned} 22 \quad & 2x + z = 4 \\ & 2x + 3y + 3z = 3 \\ & 5x + y + 3z = 10 \end{aligned}$$

$$\begin{aligned} 24 \quad & w + x - y + 3z = -1 \\ & x + 2y - 3z = -2 \\ & w + 2x + 2y + z = 0 \\ & 2w + 3x + 2y + 7z = 4 \end{aligned}$$

Solve each of the following without simply using the solve facility on a calculator.

- 25** A manufacturer of lawn mowers makes two types, the standard and the deluxe. To send 270 standard models and 220 deluxe models overseas, the manufacturer uses two types of container. Each type A container can hold 5 standard models and 2 deluxe models when full, whilst each type B container can hold 3 standard models and 4 deluxe models when full, no other arrangements quite use all the available space. By supposing that the manufacturer uses x type A containers and y type B containers write two equations that apply if the machines are sent with all the containers full. Hence determine x and y .

- 26** A vet is called to the zoo to treat a large animal. To sedate the animal the vet decides to powder up a number of tablets and give the resulting 'super-tablet' to the animal in its feed. To make this super-tablet the vet uses a combination of three tablets, P, Q and R, using p Ps, q Qs and r Rs.

Each P tablet has 250 mg of X, 10 mg of Y, and 50 mg of Z.

Each Q tablet has 500 mg of X, 5 mg of Y, and 100 mg of Z.

Each R tablet has 200 mg of X, 20 mg of Y, and 100 mg of Z.

The super-tablet the vet makes contains 8 g of X, 470 mg of Y and 2.8 g of Z. Write three equations that apply and hence find how many of each tablet the vet used.

- 27** When making x kg of fertiliser A, y kg of fertiliser B and z kg of fertiliser C, a company uses 610 kg of compound P, 180 kg of compound Q and 210 kg of compound R.

1 kg of fertiliser A contains 0.5 kg P, 0.1 kg Q, and 0.4 kg R.

1 kg of fertiliser B contains 0.3 kg P, 0.5 kg Q, and 0.2 kg R.

1 kg of fertiliser C contains 0.8 kg P, 0.1 kg Q, and 0.1 kg R.

a Write 3 equations involving x , y and z for the above information.

b Solve the equations to determine x , y and z .



Systems of linear equations having no solution

If we solve two equations in two unknowns, for example:

$$\begin{cases} 2x + y = 5 \\ x + y = 3 \end{cases}$$

the solution gives the coordinates of the point of intersection of the two lines, in this case (2, 1). This is the only solution the system of equations has.

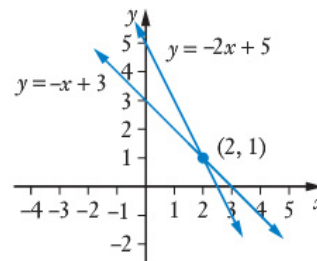

We say that $x = 2, y = 1$ is the **unique** solution.

Suppose instead we are asked to solve

$$\begin{cases} 2x + y = 5 & \text{Equation [1]} \\ 2x + y = 3 & \text{Equation [2]} \end{cases}$$

Equation [1] – Equation [2] gives $0x + 0y = 2$.

It is not possible to find values for x and y that satisfy this last equation.

The equations $2x + y = 5$ and $2x + y = 3$ contradict each other. We say the equations are **inconsistent**. It is **not** possible to find a solution to this system of equations. This contrasts with the systems met earlier in this chapter which all had unique solutions.

Graphically, $2x + y = 5$ (i.e. $y = -2x + 5$) and $2x + y = 3$ (i.e. $y = -2x + 3$), represent parallel lines. They have no points in common and so the system of equations has no solution.

We would obtain the same conclusion, i.e. that there is no solution, if we use the augmented matrix approach:

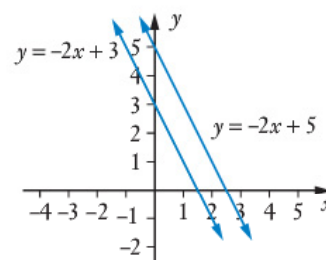

$$\begin{array}{l} r_1 \\ r_2 \end{array} \quad \begin{bmatrix} 2 & 1 & 5 \\ 2 & 1 & 3 \end{bmatrix}$$

$$\begin{array}{l} r_1 \\ r_2 - r_1 \end{array} \quad \begin{bmatrix} 2 & 1 & 5 \\ 0 & 0 & -2 \end{bmatrix} \quad \leftarrow \text{new } r_2$$

This last line is telling us that $0x + 0y = -2$ so again we conclude ‘no solution’.

Similarly, with a system of three equations involving three unknowns, if our working leads to the claim that $0x + 0y + 0z = a$, for $a \neq 0$, we again conclude ‘no solution’.

For example, consider the system:

$$\begin{cases} x + 3y + z = 2 \\ x + 2y + 4z = 0 \\ 2x + 7y - z = 1 \end{cases}$$

The augmented matrix is

$$\left[\begin{array}{ccc|c} 1 & 3 & 1 & 2 \\ 1 & 2 & 4 & 0 \\ 2 & 7 & -1 & 1 \end{array} \right]$$

which can be reduced to

$$\left[\begin{array}{ccc|c} 1 & 3 & 1 & 2 \\ 0 & -1 & 3 & -2 \\ 0 & 0 & 0 & -5 \end{array} \right]$$

The last line is claiming that $0x + 0y + 0z = a$, for $a \neq 0$, and hence we conclude ‘no solution’. The initial equations are **inconsistent**.

We know from the previous chapter that an equation of the form $ax + by + cz = d$ is the equation of a plane (i.e. a flat surface). Thus, if we have a system of three such equations which has 'no solution' it means that the three equations represent planes that have no point(s) common to all three planes. Two of the planes could be parallel for example. The various possibilities are shown below.

Three parallel planes

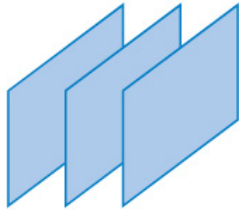

Example:
 $x - 2y + 3z = 5$
 $-x + 2y - 3z = 8$
 $2x - 4y + 6z = 7$

Augmented matrix can be reduced to:

$$\begin{bmatrix} 1 & -2 & 3 & 5 \\ 0 & 0 & 0 & 13 \\ 0 & 0 & 0 & -3 \end{bmatrix}$$

$$\begin{aligned} 0x + 0y + 0z &= 13!! \\ 0x + 0y + 0z &= -3!! \end{aligned}$$

No solution.

One plane listed twice and one other parallel plane

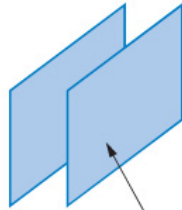

Two equations defining the same plane.

Example:
 $x - 2y + 3z = 5$
 $x - 2y + 3z = 8$
 $2x - 4y + 6z = 10$

Augmented matrix can be reduced to:

$$\begin{bmatrix} 1 & -2 & 3 & 5 \\ 0 & 0 & 0 & 3 \\ 0 & 0 & 0 & 0 \end{bmatrix}$$

$$0x + 0y + 0z = 3!!$$

No solution.

Two parallel planes and one other plane

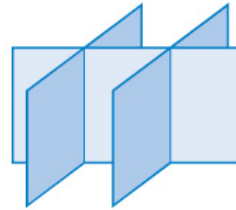

Example:
 $x - 2y + 3z = 5$
 $x + 4y - 2z = 3$
 $2x - 4y + 6z = 11$

Augmented matrix can be reduced to:

$$\begin{bmatrix} 1 & -2 & 3 & 5 \\ 0 & 6 & -5 & -2 \\ 0 & 0 & 0 & 1 \end{bmatrix}$$

$$0x + 0y + 0z = 1!!$$

No solution.

Intersecting pairs of planes form parallel lines

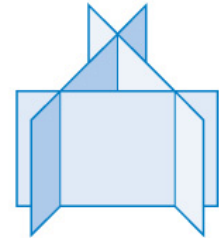

Example:
 $x + y - z = 1$
 $x - 2y - z = -2$
 $-x + 5y + z = 7$

Augmented matrix can be reduced to:

$$\begin{bmatrix} 1 & 1 & -1 & 1 \\ 0 & 1 & 0 & 1 \\ 0 & 0 & 0 & 1 \end{bmatrix}$$

$$0x + 0y + 0z = 1!!$$

No solution.

Note that equations of the form:

$$ax + by + cz = d$$

$$\mu(ax + by + cz = e),$$

for some constant $\mu (\neq 0)$,

define the same plane if $d = e$ and separate parallel planes if $d \neq e$.



Note: In the last situation, the three planes meeting in a common line, each of the original equations is a linear combination of the other two:

$$(-1)(x + y - 2z = -1) + (-1)(x + 3y + z = 0) = (-2x - 4y + z = 1)$$

This means that any one of the equations is not telling us any more about the three variables than could be obtained from the other two equations. Thus we really only have two pieces of information about the three unknowns and, provided these pieces of information are not contradictory, we have infinite solutions.

However this linear combination is not always obvious.

If the linear combination holds for the x , y and z parts of the equation but not the constant terms, then the 'two pieces of information' we have are contradictory and we have the 'no solution situation' of *intersecting pairs of planes forming three parallel lines* seen earlier.

For example for the system

$$\begin{aligned} x + y - z &= 1 \\ x - 2y - z &= -2 \\ -x + 5y + z &= 7 \end{aligned}$$

given as an example of that situation on an earlier page

$$\begin{aligned} (1)(x + y - z = 1) + (-2)(x - 2y - z = -2) &= (-x + 5y + z = 5) \\ &\neq (-x + 5y + z = 7) \end{aligned}$$

the linear combination differing from the third equation only in the constant term.

EXAMPLE 3

Determine whether the system shown on the right has a unique solution, no solution or an infinite number of solutions. If there is a unique solution, find it.

$$\begin{aligned} x - 2y + 3z &= 5 \\ -x + 2y - 3z &= 4 \\ 2x + y - z &= 4 \end{aligned}$$

Solution

Noticing that the first two equations define separate parallel planes and the third equation is not parallel to the other two, we have the situation shown on the right. Thus there is no solution.

Alternatively, had the parallel nature of two of the planes escaped our notice, manipulation of the augmented matrix would yield the same conclusion, as shown below.

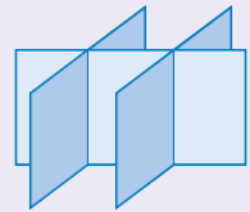

$$\begin{array}{l} r_1 \\ r_2 \\ r_3 \end{array} \left[\begin{array}{cccc} 1 & -2 & 3 & 5 \\ -1 & 2 & -3 & 4 \\ 2 & 1 & -1 & 4 \end{array} \right]$$

$$\begin{array}{l} r_1 \\ r_2 + r_1 \\ r_3 - 2r_1 \end{array} \left[\begin{array}{cccc} 1 & -2 & 3 & 5 \\ 0 & 0 & 0 & 9 \\ 0 & 5 & -7 & -6 \end{array} \right] \begin{array}{l} \\ \leftarrow \text{new } r_2 \\ \leftarrow \text{new } r_3 \end{array}$$

Row 2 is suggesting that $0x + 0y + 0z = 9$.

No values for x , y and z can satisfy this equation so again we conclude that the system has no solution.



EXAMPLE 4 REPEATED**Solution without using augmented matrix approach**

For what value(s) of p will the system of equations shown on the right have a unique solution?

$$\begin{aligned}x - 2y + z &= -3 \\ -x + 3y + z &= -2 \\ 3x - 5y + pz &= 7\end{aligned}$$

Solution

Given the three equations:

$$\begin{cases} x - 2y + z = -3 & [1] \\ -x + 3y + z = -2 & [2] \\ 3x - 5y + pz = 7 & [3] \end{cases}$$

Use equations [1] and [2] to eliminate x .

$$\begin{array}{rcl} \text{Equation [1]} & x - 2y + z & = -3 \\ \text{Equation [2]} & -x + 3y + z & = -2 \\ \text{Addition eliminates } x & y + 2z & = -5 \end{array} \quad [4]$$

Use equations [1] and [3] to eliminate x .

$$\begin{array}{rcl} \text{Equation [1]} \times 3 & 3x - 6y + 3z & = -9 \\ \text{Equation [3]} & 3x - 5y + pz & = 7 \\ \text{Subtraction eliminates } x & -y + (3 - p)z & = -16 \end{array} \quad [5]$$

Use equations [4] and [5] to eliminate y .

$$\begin{array}{rcl} \text{Equation [4]} & y + 2z & = -5 \\ \text{Equation [5]} & -y + (3 - p)z & = -16 \\ \text{Addition eliminates } y & (5 - p)z & = -21 \end{array}$$

This last equation gives a solution provided $5 - p \neq 0$, otherwise $0z = -21$!

A unique solution exists provided $5 - p \neq 0$, i.e. provided $p \neq 5$.

Alternatively, with no parallel or coincident planes involved, example 4 could be solved by considering linear combinations, as shown below. However, it is anticipated that for most students, eliminating the variables by one or other of the methods of presentation just demonstrated would be the preferred method of solution for questions of this type.

- If there exists a linear combination of the first two equations, equal to the third equation, we really only have two pieces of information about three unknowns. Hence we would have infinite solutions.
- If there exists a linear combination of the first two equations that differs from the third equation only in the last column we have contradictory statements. Hence we would have no solution.

Consider $4 \times [1] + 1 \times [2]$:
(The 4 and the 1 being obtained by solving $1\lambda - 1\mu = 3$ with $-2\lambda + 3\mu = -5$.)

$$\begin{array}{rcl} 4(x - 2y + z = -3) & + & \\ 1(-x + 3y + z = -2) & & \\ \hline 3x - 5y + 5z & = & -14 \\ 3x - 5y + pz & = & 7 \end{array}$$

Compare this with [3]:

$$\begin{array}{rcl} \text{If } p = 5 \text{ we have a contradiction:} & 3x - 5y + 5z & = -14 \\ & \text{and } 3x - 5y + 5z & = 7 \end{array}$$

This is avoided, and a unique solution will be obtained, if $p \neq 5$.

Thus, as before, a unique solution exists provided $p \neq 5$.

EXAMPLE 5 Augmented matrix approach

Determine the possible values of p and q if the system of equations shown on the right has

$$\begin{aligned}x - y + 2z &= 1 \\2x - 5y + 5z &= 9 \\3x + 3y + pz &= q\end{aligned}$$

- a** no solution,
- b** infinite solutions,
- c** a unique solution.

Solution

Using the augmented matrix:

$$\begin{array}{l}r_1 \\r_2 \\r_3\end{array} \left[\begin{array}{cccc}1 & -1 & 2 & 1 \\2 & -5 & 5 & 9 \\3 & 3 & p & q\end{array} \right]$$

$$\begin{array}{l}r_1 \\r_2 - 2r_1 \\r_3 - 3r_1\end{array} \left[\begin{array}{cccc}1 & -1 & 2 & 1 \\0 & -3 & 1 & 7 \\0 & 6 & p-6 & q-3\end{array} \right] \begin{array}{l} \\ \leftarrow \text{new } r_2 \\ \leftarrow \text{new } r_3\end{array}$$

$$\begin{array}{l}r_1 \\r_2 \\r_3 + 2r_2\end{array} \left[\begin{array}{cccc}1 & -1 & 2 & 1 \\0 & -3 & 1 & 7 \\0 & 0 & p-4 & q+11\end{array} \right] \begin{array}{l} \\ \\ \leftarrow \text{new } r_3\end{array}$$

Thus the system has

- a** no solution if $p = 4$ and $q \neq -11$ (as we then have $0x + 0y + 0z = \text{non zero}$)
- b** infinite solutions if $p = 4$ and $q = -11$ (as we then have $0x + 0y + 0z = 0$)
- c** a unique solution if $p \neq 4$.

Again these same answers could be obtained by considering what linear combination of the first two equations could give the third equation:

Solving $1\lambda + 2\mu = 3$ with $-1\lambda - 5\mu = 3$ gives $\lambda = 7$ and $\mu = -2$.

Thus we try (7) (1st row) $+ (-2)$ (2nd row):

$$\begin{array}{r} (7) \begin{pmatrix} 1 & -1 & 2 & 1 \end{pmatrix} + \\ (-2) \begin{pmatrix} 2 & -5 & 5 & 9 \end{pmatrix} \\ \hline \begin{pmatrix} 3 & 3 & 4 & -11 \end{pmatrix} \\ \hline \begin{pmatrix} 3 & 3 & p & q \end{pmatrix} \end{array}$$

Comparing this with the third row:
we again conclude that the system has

- a** no solution if $p = 4$ and $q \neq -11$, as then we would have contradictory equations. (Inconsistent.)
- b** infinite solutions if $p = 4$ and $q = -11$, as then we have a repeat equation. (Insufficient.)
- c** a unique solution if $p \neq 4$.



EXAMPLE 5 REPEATED**Solution without using augmented matrix**

Determine the possible values of p and q if the system of equations shown on the right has

$$\begin{aligned}x - y + 2z &= 1 \\2x - 5y + 5z &= 9 \\3x + 3y + pz &= q\end{aligned}$$

- a** no solution,
- b** infinite solutions,
- c** a unique solution.

Solution

Given the three equations:

$$\begin{cases}x - y + 2z = 1 & [1] \\2x - 5y + 5z = 9 & [2] \\3x + 3y + pz = q & [3]\end{cases}$$

Use equations [1] and [2] to eliminate x .

$$\begin{array}{rcl} \text{Equation [1]} \times 2 & 2x - 2y + 4z & = 2 \\ \text{Equation [2]} & 2x - 5y + 5z & = 9 \\ \hline \text{Subtraction eliminates } x & 3y - z & = -7 \quad [4] \end{array}$$

Use equations [1] and [3] to eliminate x .

$$\begin{array}{rcl} \text{Equation [1]} \times 3 & 3x - 3y + 6z & = 3 \\ \text{Equation [3]} & 3x + 3y + pz & = q \\ \hline \text{Subtraction eliminates } x & -6y + (6 - p)z & = 3 - q \quad [5] \end{array}$$

Use equations [4] and [5] to eliminate y .

$$\begin{array}{rcl} \text{Equation [4]} \times 2 & 6y - 2z & = -14 \\ \text{Equation [5]} & -6y + (6 - p)z & = 3 - q \\ \hline \text{Addition eliminates } y & (4 - p)z & = -11 - q \end{array}$$

If $p = 4$ and $q \neq -11$ we have $0z \neq 0$. No solution.

If $p = 4$ and $q = -11$ we have $0z = 0$. Infinite solutions.

If $p \neq 4$ we have 'non zero z equalling some number'. Unique solution.

Thus

- a** no solution if $p = 4$ and $q \neq -11$,
- b** infinite solutions if $p = 4$ and $q = -11$,
- c** a unique solution if $p \neq 4$.

Exercise 6B

Determine the value of k in each of the following systems of equations given that each system has no solution.

$$\begin{aligned} \mathbf{1} \quad x + 2y + z &= 3 \\ y + 4z &= 1 \\ kz &= 5 \end{aligned}$$

$$\begin{aligned} \mathbf{2} \quad x + 3y + 2z &= 4 \\ -y + 3z &= 1 \\ (k-2)z &= 3 \end{aligned}$$

$$\begin{aligned} \mathbf{3} \quad x - 2y + z &= 4 \\ y + 3z &= 1 \\ (2k+1)z &= 2 \end{aligned}$$

$$\begin{aligned} \mathbf{4} \quad x + 3y + 2z &= 1 \\ y + kz &= 2 \\ -y + 3z &= 5 \end{aligned}$$

$$\begin{aligned} \mathbf{5} \quad 2x + y + 4z &= 2 \\ 3y + kz &= 4 \\ 2y + z &= 3 \end{aligned}$$

$$\begin{aligned} \mathbf{6} \quad x + 2y + z &= 3 \\ y - 3z &= k \\ -2y + 6z &= -4 \end{aligned}$$

$$\begin{aligned} \mathbf{7} \quad (k-2)z &= 4 \\ y + 2z &= -3 \\ x + 2y + 3z &= 5 \end{aligned}$$

$$\begin{aligned} \mathbf{8} \quad y + 3z &= 2 \\ (k+1)z &= 5 \\ x + 3y - z &= 2 \end{aligned}$$

$$\begin{aligned} \mathbf{9} \quad x + 2y + kz &= 1 \\ 2x - 3y + z &= 5 \\ 3x - y + 4z &= 3 \end{aligned}$$

$$\begin{aligned} \mathbf{10} \quad x + 3y - 6z &= 3 \\ x + y + z &= 0 \\ 3x + 5y + (k+1)z &= 2 \end{aligned}$$

$$\begin{aligned} \mathbf{11} \quad 2x + y + kz &= -1 \\ x + 4y + 2z &= -7 \\ 3x - 2y + 4z &= 1 \end{aligned}$$

$$\begin{aligned} \mathbf{12} \quad x + y + 3z &= 4 \\ -x + 5y + (k+1)z &= 6 \\ 2x - y + z &= 5 \end{aligned}$$

Determine the value of k in each of the following systems of equations given that each system has infinite solutions.

$$\begin{aligned} \mathbf{13} \quad x + 3y - 2z &= 5 \\ y - 2z &= 4 \\ kz &= 0 \end{aligned}$$

$$\begin{aligned} \mathbf{14} \quad x + 2y - z &= 1 \\ z &= 2 \\ (2k+1)z &= 0 \end{aligned}$$

$$\begin{aligned} \mathbf{15} \quad x - 3y + 5z &= 5 \\ -y + 2z &= 8 \\ (k^2 - 4)z &= k + 2 \end{aligned}$$

$$\begin{aligned} \mathbf{16} \quad 2kz &= 0 \\ 3y + 2z &= 5 \\ x - y + 3z &= 5 \end{aligned}$$

$$\begin{aligned} \mathbf{17} \quad 2y + z &= 2 \\ ky &= 0 \\ x + 3y + 4z &= 2 \end{aligned}$$

$$\begin{aligned} \mathbf{18} \quad x - 2y + 3z &= -1 \\ 2x - 4y + 6z &= -2 \\ -x + 2y + kz &= 1 \end{aligned}$$

$$\begin{aligned} \mathbf{19} \quad x - y + z &= 3 \\ 2x + 3y + kz &= 2 \\ 4x + 11y - 5z &= 0 \end{aligned}$$

$$\begin{aligned} \mathbf{20} \quad x + 3y - 2z &= 4 \\ x + 5y + (k-2)z &= 3 \\ 2x + (k+1)y - 7z &= 9 \end{aligned}$$

21 For the system of equations $\begin{cases} x + py = 5 \\ 2x + 3y = q \end{cases}$ determine the values of p and q

- a** for the system to have infinite solutions,
- b** for the system to have no solution,
- c** for the system to have a unique solution.

22 For the system of equations $\begin{cases} px + 4y = 6 \\ 9x + 6y = q \end{cases}$ determine the values of p and q

- a** for the system to have infinite solutions,
- b** for the system to have no solution,
- c** for the system to have a unique solution.

For questions **23** and **24** determine the values of p and q for which the system of equations has infinite solutions.

23
$$\begin{aligned} x + 2y + z &= 3 \\ x + 3y - 2z &= 7 \\ 3x + 4y + pz &= q \end{aligned}$$

24
$$\begin{aligned} x + 3y - z &= 2 \\ 2x + 8y - 2z &= q \\ x - 3y + pz &= -1 \end{aligned}$$

For questions **25** and **26** determine the value(s) of p for which the system of equations has a unique solution.

23
$$\begin{aligned} x - 2y + z &= -2 \\ x + y + z &= 7 \\ -x + 5y + pz &= -4 \end{aligned}$$

24
$$\begin{aligned} 5x + 2y - z &= 2 \\ 2x + y &= 1 \\ -3x + y + pz &= 1 \end{aligned}$$

27 Determine whether the system shown on the right has a unique solution, no solution or infinite solutions and, if there is a unique solution, determine that solution.

$$\begin{aligned} x + 3y - z &= 5 \\ -x + 3y + z &= 5 \\ 2x + 6y - 2z &= 10 \end{aligned}$$

28 State the possible values of k and m if the system of equations shown below has

- a** a unique solution,
- b** no solution,
- c** infinite solutions.

$$x + 2y + z = 4, \quad y - 3z = 1, \quad (2k - 1)y = m + 1.$$

29 Determine whether the system shown on the right has a unique solution, no solution or infinite solutions for each of the following cases and, if there is a unique solution, determine that solution.

$$\begin{aligned} x - y + 2z &= 12 \\ -x - 2y + z &= 3 \\ 8x + 7y + pz &= q \end{aligned}$$

- a** $p = 1, q = 10,$
- b** $p = 1, q = 21,$
- c** $p = 7, q = 45.$

30 Determine the possible values of k and m if the system on the right has

- a** a unique solution,
- b** no solution,
- c** infinite solutions.

$$\begin{aligned} x - y &= m \\ x + ky - 3z &= 7 \\ 4x - y - 3z &= 3 \end{aligned}$$



Miscellaneous exercise six

This miscellaneous exercise may include questions involving the work of this chapter, the work of any previous chapters, and the ideas mentioned in the Preliminary work section at the beginning of the book.

- 1** Use vectors to prove that the medians of a triangle intersect at a point two-thirds of the way along each median, measured from the end of the median that is a vertex of the triangle.
(A median of a triangle is a straight line drawn from a vertex of the triangle to the midpoint of the opposite side.)

- 2 a** Given that $|x - a| = 5 - |x + 3|$ has exactly two solutions find the range of values a can take.
b Given that $|x - a| = 5 - |x + 3|$ has more than two solutions find the range of values a can take.

- 3** The diagram on the right shows

$$y = |x - a| \quad \text{for } x \geq 0 \text{ and } y \geq 0,$$

$$\text{and } y = |0.5x - b| \quad \text{for } x \geq 0 \text{ and } y \geq 0,$$

dividing the graph into seven regions (labelled A to G in the diagram).

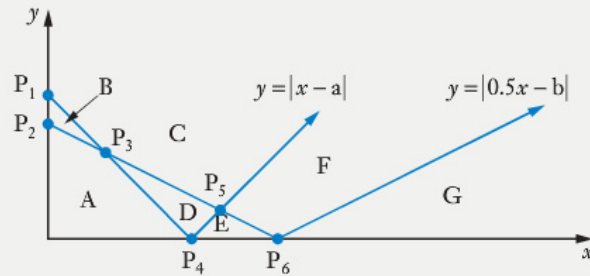

- a** Find the coordinates of P_1 and P_2 , in terms of a and/or b .

- b** Is $a > b$, or is $b > a$?

- c** Find the coordinates of P_4 and P_6 (in terms of a and/or b).

- d** Find the coordinates of P_3 and P_5 (in terms of a and/or b).

State the regions A, B, C, etc. which together form each of the following sets of points for $x \geq 0$ and $y \geq 0$:

e $\{(x, y): y < |x - a| \text{ and } y < |0.5x - b|\}$

f $\{(x, y): y > |x - a| \text{ and } y > |0.5x - b|\}$

g $\{(x, y): y < |x - a| \text{ and } y > |0.5x - b|\}$

h $\{(x, y): y > |x - a| \text{ and } y < |0.5x - b|\}$

- 4** Represent the set of points $\{z: |z - 3 - i| \leq 3\}$ as a shaded region on an Argand diagram.

- 5** Express **a** $-5(\sqrt{3} + i)$ in the form $r \operatorname{cis} \theta$ with $r \geq 0$ and $-\pi < \theta \leq \pi$,

b $6 \operatorname{cis} \left(\frac{3\pi}{4} \right)$ in the form $a + bi$.

- 6** With $z = x + iy$ and $3|z - 5| = 2|z + 5i|$ prove that

$$(x - 9)^2 + (y - 4)^2 = 72.$$

- 7** If $z = 1 - i$ **a** express z in the form $r \operatorname{cis} \theta$ with $-\pi < \theta \leq \pi$,

- b** express z^{14} in cartesian form.

- 8** Find the position vector of the point where lines L_1 and L_2 intersect where

$$\begin{aligned} L_1 \text{ has equation } & \mathbf{r} = 2\mathbf{i} + 2\mathbf{k} + \lambda(2\mathbf{i} + 3\mathbf{j} - 2\mathbf{k}) \\ \text{and } L_2 \text{ has equation } & \mathbf{r} = -2\mathbf{i} + \mathbf{j} + 6\mathbf{k} + \mu(-2\mathbf{i} - \mathbf{j} + 2\mathbf{k}). \end{aligned}$$

- 9** The diagram on the right shows the complex numbers z and w as vectors on an Argand diagram.

a Make a copy of the diagram and include on your diagram \bar{z} and \bar{w} , the complex conjugates of z and w .

b With the aid of a diagram, prove that

$$\overline{z+w} = \bar{z} + \bar{w}$$

c Similarly use a diagrammatic approach to show that $\overline{zw} = \bar{z}\bar{w}$.

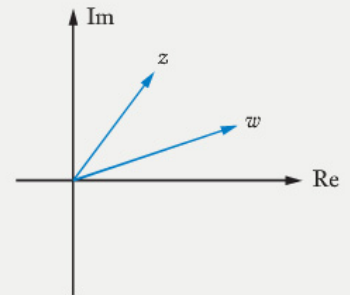

- 10** z_1 shown in the diagram on the right is one solution to the equation $z^4 = k$.

Find k and z_2, z_3 and z_4 , the other three solutions to the equation, giving all answers in the form $r \operatorname{cis} \theta^\circ$ for $r \geq 0$ and $-180 < \theta \leq 180$.

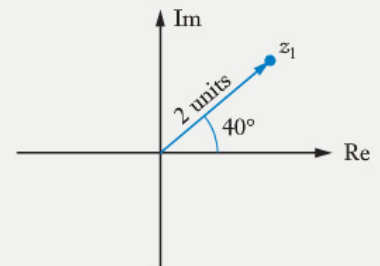

- 11 a** State the natural domain, and corresponding range of the function

$$f(x) = \frac{1}{\sqrt{x-3}} + 4$$

b Find an expression for $f^{-1}(x)$, the inverse of $f(x)$ and state the domain and range of $f^{-1}(x)$.

- 12** Use de Moivre's theorem to express $\cos 4\theta$ and $\sin 4\theta$ in terms of $\cos \theta$ and $\sin \theta$.

- 13** Two planes have equations $\mathbf{r} \cdot \begin{pmatrix} 2 \\ -3 \\ 6 \end{pmatrix} = -14$ and $\mathbf{r} \cdot \begin{pmatrix} 2 \\ -3 \\ 6 \end{pmatrix} = 42$.

Prove that the two planes are parallel and find the distance between them.

- 14** Find the shortest distance from the line $\mathbf{r} = \begin{pmatrix} 2 \\ 3 \\ -1 \end{pmatrix} + \lambda \begin{pmatrix} 5 \\ 2 \\ 1 \end{pmatrix}$ to the origin.

- 15** Prove that the system of equations given below has either no solution or infinite solutions and find the value of p that gives infinite solutions.

$$pz - 3y = 1 + x \qquad x + 3y = 3 + 2z \qquad 2x + 6y - 6z = 5$$

7.

Vector calculus

- Differentiating vector functions
- Integrating vector functions
- Some particular types of motion
- Miscellaneous exercise seven

Note

This chapter assumes that due to the probably concurrent study of Unit Three of the *Mathematics Methods* course, the reader is now familiar with the application of calculus to questions involving motion, and with differentiating and integrating trigonometrical functions and the exponential function, e^x .

In earlier chapters we encountered the idea of expressing the position vector of a moving object in terms of time, t .

For example, suppose that at some moment in time a ship is at a point with position vector $(2\mathbf{i} + 8\mathbf{j})$ km and is moving with velocity $(4\mathbf{i} - 3\mathbf{j})$ km/h (see diagram). If this motion continues, then t hours later the position vector of the ship will be

$$\begin{aligned}\mathbf{r} &= (2\mathbf{i} + 8\mathbf{j}) + t(4\mathbf{i} - 3\mathbf{j}) \\ &= (2 + 4t)\mathbf{i} + (8 - 3t)\mathbf{j}\end{aligned}$$

The position vector of the ship is given in terms of the scalar variable, t . Each value of t will output one and only one \mathbf{r} .

We have a **vector function** given in terms of the scalar variable t . Being a function of time we write the position vector as $\mathbf{r}(t)$.

Considering some general point P, cartesian coordinates (x, y) , lying on the path of this ship

$$\begin{aligned}\mathbf{r} &= x\mathbf{i} + y\mathbf{j} \\ &= (2 + 4t)\mathbf{i} + (8 - 3t)\mathbf{j}\end{aligned}$$

Thus
and

$$\begin{aligned}x &= 2 + 4t \\ y &= 8 - 3t\end{aligned}$$

← The parametric equations of the path.

Eliminating t gives

$$4y = -3x + 38$$

← The cartesian equation of the path.

Similarly, inclusion of a component in the \mathbf{k} direction can define a path in three-dimensional space.

Given $\mathbf{r}(t)$, the position vector of an object as a function of time, we can consider differentiating this function to give the rate of change of \mathbf{r} with respect to time.

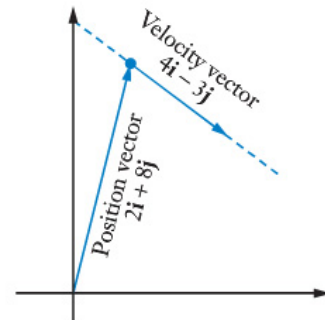

Differentiating vector functions

If $\mathbf{r} = f(t)\mathbf{i} + g(t)\mathbf{j} + h(t)\mathbf{k}$

the derivative $\frac{d\mathbf{r}}{dt}$ is determined by differentiating each component with respect to t .

$$\begin{aligned}\frac{d\mathbf{r}}{dt} &= \frac{d}{dt}(f(t)\mathbf{i} + g(t)\mathbf{j} + h(t)\mathbf{k}) \\ &= \frac{df}{dt}\mathbf{i} + \frac{dg}{dt}\mathbf{j} + \frac{dh}{dt}\mathbf{k}\end{aligned}$$



For example, if $\mathbf{r} = 2t^3\mathbf{i} + (3t - 1)\mathbf{j} - 2\mathbf{k}$

then $\frac{d\mathbf{r}}{dt} = 6t^2\mathbf{i} + 3\mathbf{j}$

Note • The derivative, $\frac{d\mathbf{r}}{dt}$, is the rate of change of \mathbf{r} with respect to t .

- As t varies the position vector $\mathbf{r}(t)$ traces out a path. At any point on this path the vector $\frac{d\mathbf{r}}{dt}$ has the same direction as that of the tangent drawn at that point, as explained below.

$$\begin{aligned} \frac{d\mathbf{r}}{dt} &= \lim_{\delta t \rightarrow 0} \frac{\mathbf{r}(t + \delta t) - \mathbf{r}(t)}{\delta t} \\ &= \lim_{\delta t \rightarrow 0} \frac{\overrightarrow{AB}}{\delta t} \quad \text{see diagram.} \end{aligned}$$

As $\delta t \rightarrow 0$ the direction of \overrightarrow{AB} will tend towards that of the tangent at A.

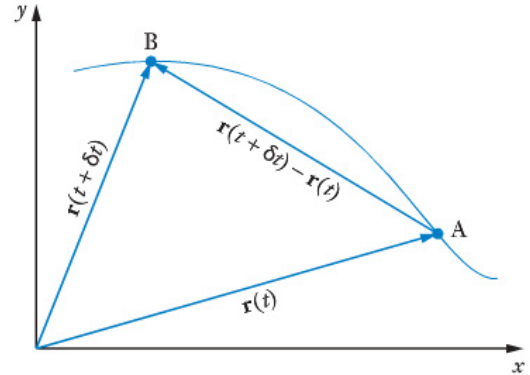

- Whilst the position vector can be given in terms of any variable,

e.g $\mathbf{r} = 3u^2\mathbf{i} + 2u\mathbf{j}$ and thus $\frac{d\mathbf{r}}{du} = 6u\mathbf{i} + 2\mathbf{j}$,

if $\mathbf{r}(t)$ is the position vector of an object at time t then $\frac{d\mathbf{r}}{dt}$ will be the velocity of the object at time t , and $\frac{d^2\mathbf{r}}{dt^2}$ its acceleration at time t .

EXAMPLE 1

A particle moves such that at time t seconds, $t \geq 0$, its position vector is \mathbf{r} metres where

$$\mathbf{r} = 2 \sin 3t\mathbf{i} + (2t^2 - 3t + 4)\mathbf{j}.$$

Find expressions for the velocity and acceleration of the particle at time t .

Solution

$$\mathbf{r} = 2 \sin 3t\mathbf{i} + (2t^2 - 3t + 4)\mathbf{j}$$

$$\mathbf{v} = \frac{d\mathbf{r}}{dt}$$

$$\therefore \mathbf{v} = 6 \cos 3t\mathbf{i} + (4t - 3)\mathbf{j}$$

$$\mathbf{a} = \frac{d\mathbf{v}}{dt}$$

$$\therefore \mathbf{a} = -18 \sin 3t\mathbf{i} + 4\mathbf{j}$$

The particle has velocity \mathbf{v} m/s and acceleration \mathbf{a} m/s² at time t where

$$\mathbf{v} = 6 \cos 3t\mathbf{i} + (4t - 3)\mathbf{j} \quad \text{and} \quad \mathbf{a} = -18 \sin 3t\mathbf{i} + 4\mathbf{j}.$$

EXAMPLE 2

A particle moves such that at time t seconds, $t \geq 0$, its position vector is \mathbf{r} m where

$$\mathbf{r} = 2t^2\mathbf{i} + (2t - 3)\mathbf{j}.$$

- Find
- a** the velocity of the particle when $t = 2$,
 - b** the speed of the particle when $t = 2$,
 - c** the angle that the velocity vector makes with the positive x direction when $t = 2$,
 - d** the acceleration of the particle when $t = 2$.

Solution

a $\mathbf{r} = 2t^2\mathbf{i} + (2t - 3)\mathbf{j}$

$$\begin{aligned}\mathbf{v} &= \frac{d\mathbf{r}}{dt} \\ &= 4t\mathbf{i} + 2\mathbf{j}\end{aligned}$$

When $t = 2$ $\mathbf{v} = 8\mathbf{i} + 2\mathbf{j}$

The particle has velocity $(8\mathbf{i} + 2\mathbf{j})$ m/s when $t = 2$.

b When $t = 2$ $|\mathbf{v}| = \sqrt{8^2 + 2^2}$
 $= 2\sqrt{17}$

The speed of the particle when $t = 2$ is $2\sqrt{17}$ m/s.

c When $t = 2$ $\mathbf{v} = 8\mathbf{i} + 2\mathbf{j}$

Thus if θ is the required angle, see diagram,

$$\tan \theta = \frac{2}{8}$$

$$\theta = 14.04^\circ, \text{ correct to two decimal places.}$$

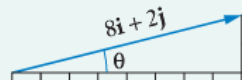

When $t = 2$ the velocity vector makes an angle of approximately 14° with the positive x direction. (Alternatively this answer could be obtained using the scalar product $\mathbf{v} \cdot \mathbf{i}$.)

d $\mathbf{v} = 4t\mathbf{i} + 2\mathbf{j}$

$$\begin{aligned}\mathbf{a} &= \frac{d\mathbf{v}}{dt} \\ &= 4\mathbf{i}\end{aligned}$$

The particle has an acceleration of $4\mathbf{i}$ m/s² when $t = 2$.

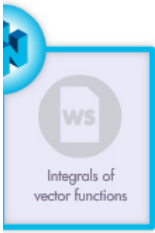

Integrating vector functions

To integrate a vector function we integrate each component.

If

$$\mathbf{r} = f(u)\mathbf{i} + g(u)\mathbf{j} + h(u)\mathbf{k}$$

$$\int \mathbf{r}(u) \, du = \left(\int f(u) \, du \right) \mathbf{i} + \left(\int g(u) \, du \right) \mathbf{j} + \left(\int h(u) \, du \right) \mathbf{k}$$

For example, if

$$\mathbf{r} = 2u\mathbf{i} + (6u^2 + 1)\mathbf{j}$$

$$\int \mathbf{r} \, du = (u^2 + c_1)\mathbf{i} + (2u^3 + u + c_2)\mathbf{j}$$

$$= u^2\mathbf{i} + (2u^3 + u)\mathbf{j} + \mathbf{c} \quad \text{where } \mathbf{c} = c_1\mathbf{i} + c_2\mathbf{j}$$

In particular if $\mathbf{r}(t)$, $\mathbf{v}(t)$ and $\mathbf{a}(t)$ represent the position vector, velocity vector and acceleration vector at time t then

$$\mathbf{r}(t) = \int \mathbf{v}(t) \, dt \quad \text{and} \quad \mathbf{v}(t) = \int \mathbf{a}(t) \, dt$$

EXAMPLE 3

A particle is initially at rest at a point with position vector $2\mathbf{j}$ m and t seconds later its acceleration is \mathbf{a} m/s² where $\mathbf{a} = 8 \cos 2t\mathbf{i} + 2\mathbf{j}$.

- Find
- a** an expression for the velocity of the particle at time t ,
 - b** the value of t ($t > 0$) when the particle is first travelling parallel to the y -axis,
 - c** an expression for the position vector of the particle at time t .

Solution

a We know that

$$\mathbf{a} = 8 \cos 2t\mathbf{i} + 2\mathbf{j}$$

$$\therefore \mathbf{v} = \int (8 \cos 2t\mathbf{i} + 2\mathbf{j}) \, dt$$

$$= 4 \sin 2t\mathbf{i} + 2t\mathbf{j} + \mathbf{c}$$

When $t = 0$, $\mathbf{v} = \mathbf{0}$. Thus

$$\mathbf{c} = \mathbf{0i} + \mathbf{0j}$$

$$\therefore \mathbf{v} = 4 \sin 2t\mathbf{i} + 2t\mathbf{j}$$

The velocity of the particle at time t is $(4 \sin 2t\mathbf{i} + 2t\mathbf{j})$ m/s.

- b** To be travelling parallel to the y -axis the \mathbf{i} component of the velocity vector must be zero.

This occurs when

$$4 \sin 2t = 0.$$

$$2t = 0, \pi, 2\pi, \dots$$

$$t = 0, \frac{\pi}{2}, \pi, \dots$$

For $t > 0$, the particle is travelling parallel to the y -axis, for the first time, when $t = \frac{\pi}{2}$.

c

$$\mathbf{r} = \int (4 \sin 2t\mathbf{i} + 2t\mathbf{j}) \, dt$$

$$= -2 \cos 2t\mathbf{i} + t^2\mathbf{j} + \mathbf{d}$$

When $t = 0$, $\mathbf{r} = 2\mathbf{j}$. Thus

$$2\mathbf{j} = -2\mathbf{i} + \mathbf{d}$$

Giving

$$\mathbf{d} = 2\mathbf{i} + 2\mathbf{j}$$

and so

$$\mathbf{r} = (2 - 2 \cos 2t)\mathbf{i} + (t^2 + 2)\mathbf{j}$$

The position vector of the particle at time t is $(2 - 2 \cos 2t)\mathbf{i} + (t^2 + 2)\mathbf{j}$ m.



7 A particle moves such that at time t seconds its position vector is \mathbf{r} m where

$$\mathbf{r} = (8t - 12)\mathbf{i} + t^2\mathbf{j}.$$

- Find
- a** how far the particle is from the origin when $t = 3$,
 - b** the velocity of the particle when $t = 3$,
 - c** the speed of the particle when $t = 3$,
 - d** the angle that the velocity vector makes with the positive x direction when $t = 3$.
(Give your answer to the nearest degree.)

8 The vector functions $\mathbf{r}(t)$ m, $\mathbf{v}(t)$ m/s and $\mathbf{a}(t)$ m/s² are respectively the position, velocity and acceleration vectors of a particle at time t seconds ($t \geq 0$).

Given that $\mathbf{r} = t^3\mathbf{i} + (2t^2 - 1)\mathbf{j}$ determine

- a** the speed of the particle when $t = 2$,
- b** the acceleration vector when $t = 3$,
- c** the scalar product $\mathbf{v} \cdot \mathbf{a}$ when $t = 2$,
- d** the angle between \mathbf{v} and \mathbf{a} when $t = 2$ giving your answer in degrees correct to one decimal place.

9 A particle moves such that at time t seconds, $t \geq 0$, its velocity is \mathbf{v} m/s where

$$\mathbf{v} = 2t\mathbf{i} + (3t^2 - 1)\mathbf{j} - 3\mathbf{k}.$$

- Find
- a** the initial speed of the particle,
 - b** the speed of the particle when $t = 2$,
 - c** the acceleration of the particle when $t = 2$,
 - d** the position vector of the particle when $t = 5$ given that when $t = 2$ the particle has position vector $(-4\mathbf{i} + 10\mathbf{j})$ m.

10 The position vector of a particle at time t seconds is \mathbf{r} m where \mathbf{r} is given by

$$\mathbf{r} = (t^2 - 6t - 16)\mathbf{i} + t^2\mathbf{j}.$$

For what value of t , $t \geq 0$, is

- a** the particle on the y -axis?
- b** the particle moving parallel to the y -axis?
- c** the velocity of the particle perpendicular to the acceleration of the particle?

11 A position vector of a particle at time t seconds is \mathbf{r} m where \mathbf{r} is given by

$$\mathbf{r} = 3\mathbf{i} + 2t\mathbf{j} + (t^2 - 4t + 10)\mathbf{k}.$$

Find the position, velocity and acceleration of the particle at the instant that the particle is at its minimum distance from the x - y plane.

- 12** With \mathbf{i} and \mathbf{j} horizontal and vertical unit vectors respectively, a body moves with a constant acceleration of $2\mathbf{j} \text{ m/s}^2$. Initially, when $t = 0$, the position vector of the body is $(\mathbf{i} + 20\mathbf{j}) \text{ m}$ and its velocity vector is $(2\mathbf{i} - 8\mathbf{j}) \text{ m/s}$.

- Find
- the velocity of the body at time t seconds,
 - the position vector of the body at time t seconds,
 - the distance the body is from the origin when $t = 3$,
 - the speed of the body when $t = 2$,
 - the value of t when the body has its minimum height and determine this minimum height,
 - the cartesian equation of the path of the body.

- 13** A particle moves with its acceleration, $\mathbf{a} \text{ m/s}^2$ at time t seconds given by

$$\mathbf{a} = \cos t \mathbf{i} + 2\mathbf{j}.$$

Initially, i.e. when $t = 0$, the particle has position vector $(4\mathbf{i} - 6\mathbf{j}) \text{ m}$ and velocity vector $\mathbf{j} \text{ m/s}$.

- Find
- the value(s) of t , $t \geq 0$, when the particle crosses the x -axis,
 - the value(s) of t , $t \geq 0$, when the particle crosses the y -axis.

- 14** An object starts from rest at the origin and moves such that its acceleration t seconds later is $\mathbf{a} \text{ m/s}^2$, where \mathbf{a} is given by

$$\mathbf{a} = -4 \sin 2t \mathbf{i} + 2\mathbf{j} + e^t \mathbf{k}.$$

Find the position vector of the object when $t = \pi$.

- 15** A body moves such that its position vector, $\mathbf{r} \text{ m}$, at time t seconds is given by

$$\mathbf{r} = 2 \sin 3t \mathbf{i} + 2 \cos 3t \mathbf{j}.$$

- Find the value of t , $t \geq 0$, when the body crosses the x -axis for the first time.
- Obtain expressions for the velocity and acceleration at time t .
- Prove that for all values of t the velocity is perpendicular to the acceleration.

- 16** An object is initially at a point A, position vector $(2\mathbf{i} + 8\mathbf{j}) \text{ m}$, and moving with velocity $-4\mathbf{i} \text{ m/s}$. The object moves such that t seconds later its acceleration is $\mathbf{a} \text{ m/s}^2$, with

$$\mathbf{a} = 2 \sin(0.5t) \mathbf{i} - 2 \cos(0.5t) \mathbf{j}.$$

How far is the object from the point B, position vector $2\mathbf{i}$, when $t = \frac{\pi}{3}$?



iStock.com/WalterWatles



Some particular types of motion

EXAMPLE 4 Particle projected from a point on a horizontal plane.

A particle is projected from a point on a horizontal plane, at 30° above the horizontal and with an initial speed of 50 m/s. The particle will experience constant downward acceleration, due to the earth's gravitational pull, of $g \text{ m/s}^2$.

With horizontal and vertical unit vectors \mathbf{i} and \mathbf{j} as shown, and taking g as 10, determine:

- the acceleration of the particle in \mathbf{i} - \mathbf{j} form,
- the initial velocity of the particle in \mathbf{i} - \mathbf{j} form,
- the velocity of the particle t seconds after projection,
- the time taken for the particle to reach its highest point.

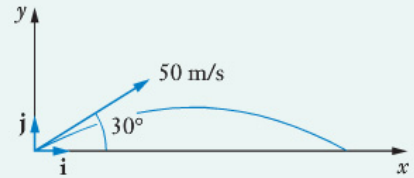

Solution

- Acceleration of the particle $= -10\mathbf{j} \text{ m/s}^2$.
- Initial velocity of the particle $= (50 \cos 30^\circ \mathbf{i} + 50 \sin 30^\circ \mathbf{j}) \text{ m/s}$
 $= (25\sqrt{3}\mathbf{i} + 25\mathbf{j}) \text{ m/s}$
- We know that $\mathbf{a} = -10\mathbf{j}$ where $\mathbf{a} \text{ m/s}^2$ is the acceleration.
 Thus $\mathbf{v} = -10t\mathbf{j} + \mathbf{c}$ where $\mathbf{v} \text{ m/s}$ is the velocity.
 When $t = 0$, $\mathbf{v} = 25\sqrt{3}\mathbf{i} + 25\mathbf{j}$ $\therefore \mathbf{c} = 25\sqrt{3}\mathbf{i} + 25\mathbf{j}$
 Thus $\mathbf{v} = 25\sqrt{3}\mathbf{i} + (25 - 10t)\mathbf{j}$
 The velocity of the particle t seconds after projection is $[25\sqrt{3}\mathbf{i} + (25 - 10t)\mathbf{j}] \text{ m/s}$.
- At the highest point the vertical component of the velocity must be zero.
 i.e. $25 - 10t = 0$
 giving $t = 2.5$.
 The particle is at its highest point 2.5 seconds after projection

Note

Readers with some knowledge of basic physics may recognise that part **d** of the above example could be solved using the formula, $v = u + at$. However remember that this formula is one of a group that apply to constant acceleration situations. The calculus techniques we are developing here apply to variable acceleration as well.

Exercise 7B

Rectilinear motion with constant acceleration

- 1** At time $t = 0$ a particle is at the origin and moving with velocity $u\mathbf{i}$ m/s.
If the particle travels under the influence of a constant acceleration $a\mathbf{i}$ m/s² find expressions for the velocity and position vector of the particle t seconds later.

Particle projected from a point on a horizontal plane

- 2** An object is projected from a point O on a horizontal surface with an initial velocity of $(14\mathbf{i} + 35\mathbf{j})$ m/s where \mathbf{i} and \mathbf{j} are horizontal and vertical unit vectors respectively.
The object experiences constant downward acceleration of $-9.8\mathbf{j}$ m/s².
Find an expression for the position vector of the object, with respect to point O, t seconds into its flight.
How far is the object from O when $t = 5$?
Determine the cartesian equation of the path.
(Note: Your answer should be a quadratic, thus showing that the flight path is parabolic).

- 3** A particle is projected with an initial speed of 80 m/s at 60° above the horizontal from a point O on a horizontal surface.
The particle experiences constant downward acceleration of g m/s².

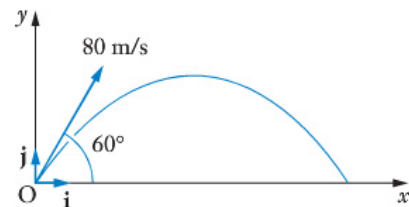

With horizontal and vertical unit vectors \mathbf{i} and \mathbf{j} as shown, and taking g as 10, determine

- a** the acceleration of the particle in \mathbf{i} - \mathbf{j} form,
b the initial velocity of the particle in \mathbf{i} - \mathbf{j} form,
c the position vector of the particle, with respect to O, t seconds after projection,
d the time taken for the particle to return to the horizontal surface.
e the horizontal distance from projection to landing.
- 4** A golfer hits the ball from a point A towards some point B, on the same level as A and 120 m away. The ball has initial speed 42 m/s, at an angle θ above the horizontal. The horizontal and vertical unit vectors are \mathbf{i} and \mathbf{j} respectively and the ball experiences constant acceleration of $-9.8\mathbf{j}$ m/s².
- a** Find an expression for the position vector of the ball with respect to A, in terms of t , the time of flight, and θ .
b Determine the two possible values of θ that will cause the ball to land at B.
(Give your answers in degrees and rounded to one decimal place.)



iStock.com/MichaelSvoboda

- 5** A particle is projected with an initial speed of u m/s at an angle θ° above the horizontal from a point O on a horizontal surface.

The particle experiences constant downward acceleration of g m/s².

With the unit vectors \mathbf{i} and \mathbf{j} as shown, determine the following (leaving u , θ and g in your answers)

- the velocity of the particle, in \mathbf{i} - \mathbf{j} form, t seconds after projection,
- the position vector of the particle, in \mathbf{i} - \mathbf{j} form, t seconds after projection,
- the time taken for the particle to return to the horizontal surface,
- the horizontal distance from O to the point of landing back on the horizontal surface,
- the value of θ that would make the distance of part **d** a maximum.

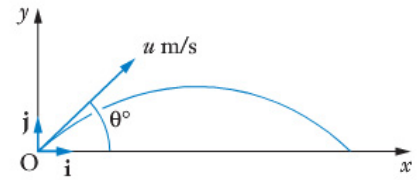

Circular motion with constant angular speed

- 6** Consider a particle initially at the point $(2, 0)$ and moving around a circle of radius 2 m with constant angular speed 0.5 rad/s. The position vector of the particle, t seconds later, is $\mathbf{r}(t)$ m where

$$\mathbf{r}(t) = 2 \cos(0.5t)\mathbf{i} + 2 \sin(0.5t)\mathbf{j}.$$

- The velocity and acceleration vectors of the particle at time t seconds are $\mathbf{v}(t)$ m/s and $\mathbf{a}(t)$ m/s² respectively. Find $\mathbf{v}(t)$ and $\mathbf{a}(t)$.
- Show that $|\mathbf{v}(t)|$ is independent of t and determine its value.
- Determine $\mathbf{v} \cdot \mathbf{a}$ and interpret the result.
- Show that $\mathbf{a}(t) = -k\mathbf{r}(t)$ for k a scalar constant and determine its value.
- What does the result $\mathbf{a}(t) = -k\mathbf{r}(t)$ mean in terms of the direction of \mathbf{a} ?

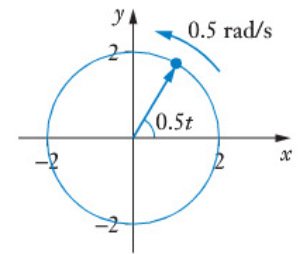

- 7** (All units use metres and seconds.)

A particle moves in a circle, centre $(0, 0)$.

The motion is such that $\mathbf{r}(0)$, the position vector when $t = 0$, is $5\mathbf{j}$.

The velocity at time t is given by

$$\mathbf{v}(t) = -\frac{5\pi}{2} \cos\left(\frac{\pi}{2}t\right)\mathbf{i} - \frac{5\pi}{2} \sin\left(\frac{\pi}{2}t\right)\mathbf{j}$$

- Determine $\mathbf{r}(t)$ the position vector of the particle at time t .
- Determine $\mathbf{r}(3)$.
- Sketch the path of the particle, indicating on your sketch the location and direction of motion of the particle at $t = 0$, $t = 1$ and at $t = 3$.
- Find $\int_0^3 \mathbf{v}(t) dt$, $\left| \int_0^3 \mathbf{v}(t) dt \right|$ and $\int_0^3 |\mathbf{v}(t)| dt$ and interpret each answer in terms of the motion of the particle from $t = 0$ to $t = 3$.

Miscellaneous exercise seven

This miscellaneous exercise may include questions involving the work of this chapter, the work of any previous chapters, and the ideas mentioned in the Preliminary work section at the beginning of the book.

1 Express $(-\sqrt{3} + i)$ in the form $r \operatorname{cis} \theta$ with $r \geq 0$ and $-\pi < \theta \leq \pi$.

2 Express the complex number $6 \operatorname{cis} \left(\frac{3\pi}{4} \right)$ in the form $a + bi$.

3 If $f(x) = \begin{cases} x + 4 & \text{for } x \leq 0 \\ x^2 & \text{for } 0 < x < 3 \\ 3x & \text{for } x \geq 3 \end{cases}$ determine $f^{-1}(x)$, the inverse of $f(x)$.

4 For which of the following functions is the graph as shown on the right?

$$f(x) = \sqrt{x^2}$$

$$g(x) = |x|$$

$$h(x) = \begin{cases} -x & \text{for } x \leq 0 \\ x & \text{for } x > 0 \end{cases}$$

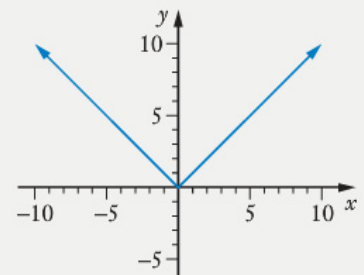

5 If $f(x) = 3 + \sqrt{x+1}$ determine a formula for $f^{-1}(x)$, the inverse of $f(x)$, and state its domain and range.

6 Vectors \mathbf{p} and \mathbf{q} are as shown in the diagram on the right.

- Write \mathbf{p} in the form $a\mathbf{i} + b\mathbf{j} + c\mathbf{k}$.
- Write \mathbf{q} in the form $a\mathbf{i} + b\mathbf{j} + c\mathbf{k}$.
- Find, to the nearest degree, the angle between \mathbf{p} and \mathbf{q} .
- Find, to the nearest degree, the acute angle between \mathbf{p} and the x -axis.
- Find, to the nearest degree, the acute angle between \mathbf{q} and the y -axis.

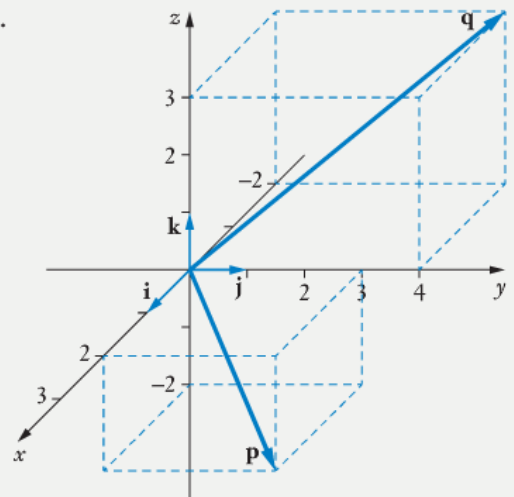

7 Find a unit vector parallel to the resultant of $(\mathbf{i} + 5\mathbf{j} - 4\mathbf{k})$ and $(\mathbf{i} - 3\mathbf{j} + 3\mathbf{k})$.

8 Without the assistance of a calculator find $\mathbf{a} \times \mathbf{b}$ given $\mathbf{a} = \begin{pmatrix} 2 \\ 3 \\ -2 \end{pmatrix}$ and $\mathbf{b} = \begin{pmatrix} 3 \\ -2 \\ 2 \end{pmatrix}$.

- 9** State the domain and range of $g(f(x))$ if $f(x) = 5\sqrt{x}$ and $g(x) = \sqrt{4-x}$.
- 10** Find the initial velocity, initial speed and initial acceleration of a particle given that its position vector t seconds into the motion is \mathbf{r} metres where

$$\mathbf{r} = (6t + 1)\mathbf{i} + (t^3 + t^2 + 8t)\mathbf{j}.$$

- 11** On squared paper, and with an x -axis from -10 to 10
and a y -axis from 0 to 20 ,
accurately draw $y = |x - 5|$
and $y = |x + 5|$.

Hence draw $y = |x - 5| + |x + 5|$

For what values of x is $|x - 5| + |x + 5| \leq 14$?

- 12** If $z = a + ib$ and \bar{z} is the complex conjugate of z find

a $z + \bar{z}$, **b** $z - \bar{z}$, **c** $z\bar{z}$, **d** $z + \bar{z}$.

- 13** Point A has position vector $\begin{pmatrix} 1 \\ 6 \\ -7 \end{pmatrix}$ and point B has position vector $\begin{pmatrix} -4 \\ 1 \\ 3 \end{pmatrix}$.

Find the position vector of the point P that divides AB internally in the ratio 4:1.

- 14** If $f(x) = x^2$ and $g(x) = \sqrt{x-9}$ find the functions $f \circ g(x)$ and $g \circ f(x)$ in terms of x and state the natural domain and range of each.
- 15** If $f(x) = x^2$ and $g(x) = \sqrt{9-x}$ find the functions $f \circ g(x)$ and $g \circ f(x)$ in terms of x and state the natural domain and range of each.
- 16** For each of the following conditions show diagrammatically the set of all points z lying in the complex plane and obeying the condition.

a $\operatorname{Re} z > \operatorname{Im} z$.

b $|z| \leq 3$.

c Both $3 \leq |z| \leq 5$ and $\frac{\pi}{6} \leq \arg z \leq \frac{\pi}{4}$.

d $\arg(z - (2 + i)) = \frac{\pi}{4}$.

- 17** Show that the set of all points z in the complex plane that are such that

$$|z - 1| = 2|z - i|$$

together form a circle in the complex plane and find the centre and radius of the circle.

- 18** Find a unit vector perpendicular to $\begin{pmatrix} -8 \\ 4 \\ 1 \end{pmatrix}$.



- 19** For $\{z: |z - 12 - 5i| = 4\}$ determine
- the minimum possible value of $\text{Im}(z)$.
 - the maximum possible value of $|\text{Re}(z)|$.
 - the maximum possible value of $|z|$.
 - the minimum possible value of $|z|$.
 - the minimum possible value of $\arg(z)$, giving your answer in radians correct to three decimal places.
 - the maximum possible value of $\arg(z)$, giving your answer in radians correct to three decimal places.

- 20** Determine whether or not the lines L_1 and L_2 intersect and, if they do, determine the position vector of their point of intersection given that

$$\begin{aligned} L_1 \text{ has equation } \quad \mathbf{r} &= 3\mathbf{i} + 2\mathbf{j} - \mathbf{k} + \lambda(4\mathbf{i} + \mathbf{j} + 3\mathbf{k}) \\ \text{and } L_2 \text{ has equation } \quad \mathbf{r} &= 2\mathbf{i} + \mathbf{j} + \mathbf{k} + \mu(3\mathbf{i} + \mathbf{j} + 2\mathbf{k}). \end{aligned}$$

- 21** The graph on the right shows the curves

$$\begin{aligned} |\mathbf{r}| &= a \\ |\mathbf{r}| &= b \quad (b > a) \end{aligned}$$

and $|\mathbf{r}| = c\theta$
with a, b and c all positive integers.

Find a, b and c and the $(|\mathbf{r}|, \theta)$ coordinates (called polar coordinates) of points A and B, the points where two curves intersect.

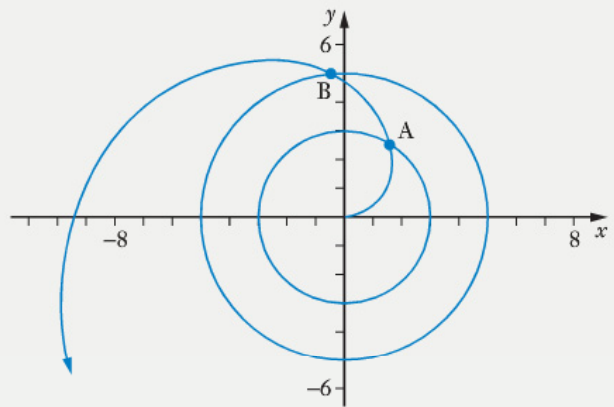

- 22** Find the position vector of the point where the line L meets the plane Π given that L has equation

$$\mathbf{r} = \begin{pmatrix} -1 \\ -10 \\ 4 \end{pmatrix} + \lambda \begin{pmatrix} 2 \\ 3 \\ -1 \end{pmatrix} \quad \text{and} \quad \Pi \text{ has equation } \mathbf{r} \cdot \begin{pmatrix} 2 \\ 4 \\ -1 \end{pmatrix} = 5.$$

- 23** The four sets of points given below all represent the same straight line in the complex plane.

$$\{z: |z - (3 + 5i)| = |z - (7 - i)|\} \qquad \{z: |z - (1 + 8i)| = |z - (a + bi)|\}$$

$$\{z: |z - 15| = |z - (c + di)|\} \qquad \{z: |z - 7 + 14i| = |z + e + fi|\}$$

Find the values of a, b, c, d, e and f . (Hint: Use an Argand diagram.)

- 24** Express the vector $\begin{pmatrix} -6 \\ 5 \\ -3 \end{pmatrix}$ in the form $\lambda\mathbf{a} + \mu\mathbf{b} + \eta\mathbf{c}$ where

$$\mathbf{a} = \begin{pmatrix} 2 \\ 3 \\ 1 \end{pmatrix}, \quad \mathbf{b} = \begin{pmatrix} 1 \\ 4 \\ -1 \end{pmatrix} \quad \text{and} \quad \mathbf{c} = \begin{pmatrix} 2 \\ 0 \\ 0 \end{pmatrix}.$$

- 37** An object is projected from a point $(0, 0)$, on horizontal ground, with an initial speed of u m/s at an angle θ above the horizontal. Use as your starting point the fact that this object will experience a constant acceleration of $-g\mathbf{j}$ m/s² and then use calculus to determine
- an expression for the position vector of the object t seconds after projection,
 - the possible values of θ if an object projected with speed 50 m/s is to pass through a point with position vector $(100\mathbf{i} + 40\mathbf{j})$ metres. Use $g = 10$ and give your answers in degrees correct to one decimal place.

38 Given the system of equations:

$$\begin{aligned}x + 2y + z &= 2 \\x - 3y + 2z &= 10 \\2x + 3y + z &= 2 \\x + 5y + 4z &= 8\end{aligned}$$

a student writes the augmented matrix:

$$\left[\begin{array}{ccc|c} 1 & 2 & 1 & 2 \\ 1 & -3 & 2 & 10 \\ 2 & 3 & 1 & 2 \\ 1 & 5 & 4 & 8 \end{array} \right]$$

and correctly reduces it to:

$$\left[\begin{array}{ccc|c} 1 & 2 & 1 & 2 \\ 0 & -5 & 1 & 8 \\ 0 & 0 & 6 & 18 \\ 0 & 0 & 0 & 0 \end{array} \right]$$

Thus reducing the initial four equations to:

$$\begin{aligned}x + 2y + z &= 2 \\0x - 5y + z &= 8 \\0x + 0y + 6z &= 18 \\0x + 0y + 0z &= 0\end{aligned}$$

Noticing the last of these equations the student concludes that the initial system has no solutions. Was the student correct in this conclusion? Explain your answer and, if you disagree with the student's conclusion, state clearly what you think the conclusion should be.

- 39** A golfer hits a ball from point T, giving it an initial velocity $(30\mathbf{i} + 24\mathbf{j})$ m/s where \mathbf{i} and \mathbf{j} are horizontal and vertical unit vectors respectively.
- The ball lands at a point L where L has a position vector relative to T of $(135\mathbf{i} + c\mathbf{j})$ m.
- Throughout its flight the ball is subject to an acceleration of $-10\mathbf{j}$ m/s², due to gravity.
- Find an expression for the velocity of the ball t seconds into its flight.
 - Find an expression for the position vector of the ball, relative to point T, t seconds into its flight.
 - What time passes from the ball leaving T to it reaching the highest point in its path?
 - What time passes from the ball leaving T to it reaching L?
 - What is the greatest height reached by the ball?
 - Find the value of c .



- 40** An earlier chapter asked you to use proof by induction to prove de Moivre's theorem

$$(\cos \theta + i \sin \theta)^n = \cos(n\theta) + i \sin(n\theta),$$

for positive integer values of n .

Now suppose that n is a negative integer, i.e. $n = -k$ for k a positive integer.

Prove that

$$(\cos \theta + i \sin \theta)^n = \cos(n\theta) + i \sin(n\theta),$$

for n a negative integer.

- 41** With the complex numbers

$$z_1 = \sqrt{6} \operatorname{cis}\left(\frac{5\pi}{6}\right) \quad z_2 = 2 \operatorname{cis}\left(\frac{\pi}{2}\right) \quad \text{and} \quad z_3 = 3 \operatorname{cis}\left(\frac{2\pi}{3}\right),$$

and without the assistance of a calculator, simplify $\left(\frac{z_1}{z_2 z_3}\right)^{-3}$.

- 42** Determine, with justification, whether the system of equations shown below has a unique solution, no solution or infinite solutions and, if there is a unique solution, determine that solution.

$$\begin{aligned} x + 3y - z &= 3 \\ -x - 3y + z &= 3 \\ 2x + 6y - 2z &= 6 \end{aligned}$$

- 43** For the system of equations:
- $$\begin{aligned} 3x + 2y + z &= 4 \\ x - y + 2z &= 3 \\ 3x + 7y + pz &= q \end{aligned}$$

- a** determine the value(s) of p and q for there to be infinite solutions,
b determine the value(s) of p and q for there to be no solutions.

- c** If $p = k$ and $q = k + 7$ and the system has a unique solution of $\begin{cases} x = m \\ y = n \\ z = 3 \end{cases}$, find m , n , p and q .

- 44** If we take the origin as the point where the post supporting my mailbox meets the ground, then

my movement-activated light is situated at a point with position vector $\begin{pmatrix} -1 \\ 8 \\ 5 \end{pmatrix}$ m.

The light is set to switch on if a person, or sufficiently large animal, comes within 6 metres of the light.

A 'sufficiently large' dog walks up the sloping verge at the front of the house and follows the line with vector equation

$$\mathbf{r} = \begin{pmatrix} -2 \\ 0 \\ 0 \end{pmatrix} + \lambda \begin{pmatrix} -1 \\ 1 \\ 1 \end{pmatrix}.$$

If the dog continues along this line does it cause the light to switch on? (Justify your answer.)

Mathematics Specialist

Unit Four

4

UNIT FOUR PRELIMINARY WORK

Having reached this stage of the book it is naturally assumed that you are already familiar with the work of the previous chapters (as well as Units One and Two of the *Mathematics Specialist* course and Units One and Two of the *Mathematics Methods* course). It is also assumed that you are familiar with the content of Unit Three of the *Mathematics Methods* course.

In particular, for this unit, familiarity with the following concepts will be assumed:

Differentiation

- Second and higher-order derivatives.
- The product, quotient and chain rules.
- Applications to curve sketching.
- Rates of change.
- Application to rectilinear motion.
- Optimisation.
- Small changes and marginal rates of change.
- Differentiation of e^x and $e^{f(x)}$.
- Differentiation of trigonometric functions.

Antidifferentiation and Integration

- Antidifferentiating algebraic and trigonometric functions.
- Antidifferentiating expressions involving e^x and $e^{f(x)}$.
- The fundamental theorem of calculus.
- Indefinite and definite integrals.
- Area under and between curves.
- Application to rectilinear motion.
- Total change from rate of change.

Statistics

It will also be assumed that the statistical concepts of the measures of central tendency (mean and median) and of dispersion (range and standard deviation) are familiar concepts.



Trigonometric identities

From your study of earlier *Mathematics Specialist* units, and of units from *Mathematics Methods*, it is assumed that you are already familiar with the following trigonometrical identities:

$$\sin^2 \theta + \cos^2 \theta = 1$$

from which it follows that
and

$$\begin{aligned}\tan^2 \theta + 1 &= \sec^2 \theta \\ 1 + \cot^2 \theta &= \operatorname{cosec}^2 \theta\end{aligned}$$

$$\sin(A \pm B) = \sin A \cos B \pm \cos A \sin B$$

from which it follows that

$$\sin 2A = 2 \sin A \cos A$$

$$\cos(A \pm B) = \cos A \cos B \mp \sin A \sin B$$

from which it follows that

$$\begin{aligned}\cos 2A &= \cos^2 A - \sin^2 A \\ &= 1 - 2 \sin^2 A \\ &= 2 \cos^2 A - 1\end{aligned}$$

$$\tan(A \pm B) = \frac{\tan A \pm \tan B}{1 \mp \tan A \tan B}$$

from which it follows that

$$\tan 2A = \frac{2 \tan A}{1 - \tan^2 A}$$

And the following rules for the products of sines and cosines:

$$\sin A \cos B = \frac{1}{2} [\sin(A+B) + \sin(A-B)] \qquad \sin P + \sin Q = 2 \sin\left(\frac{P+Q}{2}\right) \cos\left(\frac{P-Q}{2}\right)$$

$$\cos A \sin B = \frac{1}{2} [\sin(A+B) - \sin(A-B)] \qquad \sin P - \sin Q = 2 \cos\left(\frac{P+Q}{2}\right) \sin\left(\frac{P-Q}{2}\right)$$

$$\cos A \cos B = \frac{1}{2} [\cos(A+B) + \cos(A-B)] \qquad \cos P + \cos Q = 2 \cos\left(\frac{P+Q}{2}\right) \cos\left(\frac{P-Q}{2}\right)$$

$$\sin A \sin B = \frac{1}{2} [\cos(A-B) - \cos(A+B)] \qquad \cos P - \cos Q = -2 \sin\left(\frac{P+Q}{2}\right) \sin\left(\frac{P-Q}{2}\right)$$

Limit of a sum

It is assumed that your familiarity with the fundamental theorem of calculus means that you understand that we can write the **limit of a sum**

$$\lim_{\delta x \rightarrow 0} \sum_{x=a}^{x=b} f(x) \delta x$$

as the **definite integral**

$$\int_a^b f(x) dx,$$

and that this definite integral can be evaluated using **antidifferentiation**.

Use of technology

As with the previous unit you are encouraged to use your calculator, computer programs and the internet whenever appropriate during this unit.

However, whilst familiarity with these technologies is assumed, you should make sure that you can also perform the basic processes without the assistance of such technology when required to do so.

Note

The illustrations of calculator displays shown in the book may not exactly match the display from your calculator. The illustrations are not meant to show you exactly what your calculator will necessarily display but are included more to inform you that at that moment the use of a calculator could well be appropriate.

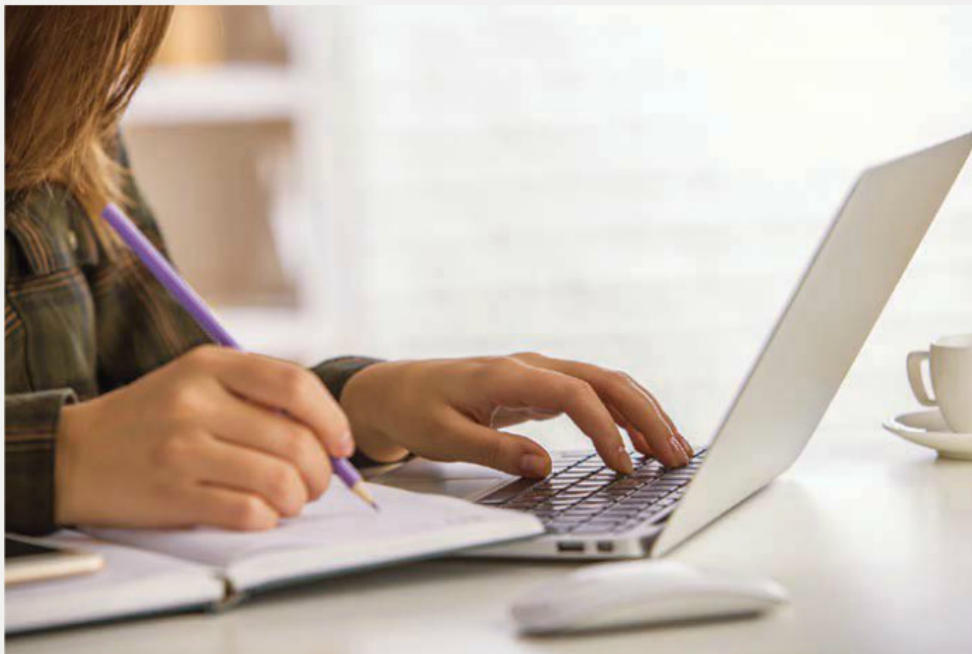

Shutterstock.com/Peshkova

8.

Differentiation techniques and applications

- Explicitly defined and implicitly defined functions
- Differentiation of implicitly defined functions
- Differentiation of parametrically defined functions
- Related rates
- Small changes
- Marginal rates of change
- Logarithmic differentiation
- Miscellaneous exercise eight

Explicitly defined and implicitly defined functions

When a function is expressed in the form $y = f(x)$, the relationship that exists between the two variables is clearly defined with one variable isolated on one side of the equation and all other terms, containing only the other variable, on the other side. For example:

$$y = 2x + 3, \quad y = \frac{x-3}{x+5}, \quad y = 2x^3 + 7x^2 - 3x + 4.$$

In this form, the functions are defined **explicitly**.

Consider instead a function defined by the equation $xy + y - 4x = -2$. In this form the relationship between x and y is implied, but is not explicitly set out. The function is said to be defined **implicitly**.

Differentiation of implicitly defined functions

Suppose we want to find the gradient at a particular point on the graph of an implicitly defined function.

For example, suppose we want to determine the gradient of

$$xy + y - 4x = -2$$

at the point $(5, 3)$.

For this particular example we could rearrange the given expression into an explicitly defined form and then differentiate as usual:

If $xy + y - 4x = -2$

then $y(x + 1) = 4x - 2$

$$y = \frac{4x - 2}{x + 1}$$

Hence $\frac{dy}{dx} = \frac{(x+1)(4) - (4x-2)(1)}{(x+1)^2}$

At $(5, 3)$ $\frac{dy}{dx} = \frac{(6)(4) - (18)(1)}{36}$

$$\frac{dy}{dx} = \frac{1}{6}$$

$$\left. \frac{d}{dx} \left(\frac{4x-2}{x+1} \right) \right|_{x=5}$$

$$\frac{1}{6}$$

However it is possible to differentiate the implicitly defined function

$$xy + y - 4x = -2$$

directly, without first isolating y , as shown on the next page.



Given:

$$xy + y - 4x = -2$$

Differentiate with respect to x :

$$\frac{d}{dx}(xy) + \frac{d}{dx}(y) - \frac{d}{dx}(4x) = \frac{d}{dx}(-2)$$

$$y \frac{d}{dx}(x) + x \frac{d}{dx}(y) + \frac{dy}{dx} - 4 = 0$$

$$y(1) + x \frac{dy}{dx} + \frac{dy}{dx} - 4 = 0$$

At $(5, 3)$

$$3 + 5 \frac{dy}{dx} + \frac{dy}{dx} - 4 = 0$$

$$6 \frac{dy}{dx} = 1$$

$$\therefore \frac{dy}{dx} = \frac{1}{6}, \quad \text{as before.}$$

This second method may not be any quicker than the first but in some cases the task of isolating y may be difficult and perhaps even impossible. This would deny the use of the first method but the second method would still work.

This second method is further demonstrated in the examples that follow.

In these examples note especially the use of the rearrangement

$$\frac{d}{dx} f(y) = \frac{d}{dy} f(y) \frac{dy}{dx} \quad (\text{i.e. the chain rule}).$$

Note also that whilst the implicitly defined equations may represent a relationship that is not a function, $\frac{dy}{dx}$ can still be determined.

EXAMPLE 1

Find $\frac{dy}{dx}$ in terms of x and y if $y^2 + 5x = 6x^2y$.

Solution

Given:

$$y^2 + 5x = 6x^2y$$

Differentiate with respect to x :

$$\frac{d}{dx}(y^2) + \frac{d}{dx}(5x) = \frac{d}{dx}(6x^2y)$$

$$\frac{d}{dy}(y^2) \frac{dy}{dx} + 5 = y \frac{d}{dx}(6x^2) + 6x^2 \frac{d}{dx}(y)$$

$$2y \frac{dy}{dx} + 5 = 12xy + 6x^2 \frac{dy}{dx}$$

$$\therefore \frac{dy}{dx}(2y - 6x^2) = 12xy - 5$$

Thus

$$\frac{dy}{dx} = \frac{12xy - 5}{2y - 6x^2}$$



Alternatively, using a calculator:

$$\text{impDiff}(y^2 + 5x = 6x^2y, x, y)$$

$$y' = \frac{-(12 \cdot x \cdot y - 5)}{2 \cdot (3 \cdot x^2 - y)}$$

EXAMPLE 2

Determine the gradient of the curve $3y^2 + 4x = x^2 + 2xy - 8$ at the point $(5, 3)$.

Solution

Given:

$$3y^2 + 4x = x^2 + 2xy - 8$$

Differentiate with respect to x :

$$\frac{d}{dx}(3y^2) + \frac{d}{dx}(4x) = \frac{d}{dx}(x^2) + \frac{d}{dx}(2xy) - \frac{d}{dx}(8)$$

$$\frac{d}{dy}(3y^2) \frac{dy}{dx} + 4 = 2x + y \frac{d}{dx}(2x) + 2x \frac{d}{dx}(y)$$

$$6y \frac{dy}{dx} + 4 = 2x + 2y + 2x \frac{dy}{dx}$$

At $(5, 3)$

$$18 \frac{dy}{dx} + 4 = 10 + 6 + 10 \frac{dy}{dx}$$

\therefore

$$\frac{dy}{dx} = \frac{3}{2}$$

At $(5, 3)$ the curve has gradient $\frac{3}{2}$.

$$\text{impDif}(3 \cdot y^2 + 4 \cdot x = x^2 + 2 \cdot x \cdot y - 8, x, y) | x = 5$$

$$\frac{y+3}{3 \cdot y-5}$$

$$\frac{y+3}{3 \cdot y-5} | y = 3$$

$$\frac{3}{2}$$

EXAMPLE 3

If $y^2 + x = x^3 - y + 6$ determine $\frac{dy}{dx}$ and $\frac{d^2y}{dx^2}$ in terms of x and y and evaluate each of these for the point $(1, 2)$.

Solution

Given

$$y^2 + x = x^3 - y + 6$$

Differentiate with respect to x :

$$\frac{d}{dx}(y^2) + \frac{d}{dx}(x) = \frac{d}{dx}(x^3) - \frac{d}{dx}(y) + \frac{d}{dx}(6)$$

$$\frac{d}{dy}(y^2) \frac{dy}{dx} + 1 = 3x^2 - \frac{dy}{dx}$$

$$2y \frac{dy}{dx} + 1 = 3x^2 - \frac{dy}{dx}$$

$$\frac{dy}{dx}(2y + 1) = 3x^2 - 1$$

$$\frac{dy}{dx} = \frac{3x^2 - 1}{2y + 1}$$

At the point $(1, 2)$

$$\begin{aligned} \frac{dy}{dx} &= \frac{3(1)^2 - 1}{2(2) + 1} \\ &= \frac{2}{5} \end{aligned}$$

$\frac{d^2y}{dx^2}$ is the second derivative of y with respect to x .

Thus

$$\begin{aligned} \frac{d^2y}{dx^2} &= \frac{d}{dx} \left(\frac{dy}{dx} \right) \\ &= \frac{d}{dx} \left(\frac{3x^2 - 1}{2y + 1} \right) \\ &= \frac{(2y + 1)6x - (3x^2 - 1)2 \frac{dy}{dx}}{(2y + 1)^2} \\ &= \frac{(2y + 1)6x - (3x^2 - 1)2 \frac{3x^2 - 1}{2y + 1}}{(2y + 1)^2} \\ &= \frac{6x(2y + 1)^2 - 2(3x^2 - 1)^2}{(2y + 1)^3} \\ \frac{d^2y}{dx^2} &= \frac{6(1)(5)^2 - 2(2)^2}{(5)^3} \\ &= \frac{142}{125} \end{aligned}$$



Investigate the ability of your calculator to determine the second derivative of implicitly defined functions.

At the point $(1, 2)$



Exercise 8A

Without first rearranging the equation, differentiate each of the following with respect to x to find $\frac{dy}{dx}$ in terms of x and y .

- 1** $xy + 8x = 10 - 2y$ **2** $xy + y - 4x = 3x^2 - 5$ **3** $y^3 - 2x = 3x^2y$
4 $y^2 = 2x^3y + 5x$ **5** $5y^2 = x^2 + 2xy - 3x$ **6** $x + 3y^2 = 5 + x^2 + 2xy$
7 $x^2 + y^2 = 9x$ **8** $x^2 + y^2 = 9y$ **9** $x^2 + y^2 = 9xy$
10 $x^2 + y^2 = 9xy + x + y$ **11** $\sin x + \cos y = 10$ **12** $3 + x^2 \cos y = 10xy$
- 13** Determine the gradient of $6x + xy + 20 + 2y = 0$ at the point $(-3, 2)$.
14 Determine the gradient of $6y + xy = 10 + 3x$ at the point $(2, 2)$.
15 Determine the gradient of $5 + x^3 = xy + y^2$ at the point $(1, -3)$.
16 Determine the gradient of $y^2 + 3xy = 4x$ at the point $(1, -4)$.
17 Find the equation of the tangent to $x^2 + \frac{y}{x} = 2y$ at the point $(1, 1)$.
18 Determine the gradient of $5x^2 + \sqrt{xy} = 5 + y^2$ at the point $(4, 9)$.
19 If $\frac{dy}{dx} = x^2y$ find an expression for $\frac{d^2y}{dx^2}$ in terms of x and y .
20 Determine the coordinates of the points on the graph of $x^2 + 4y^2 - 2x + 6y = 17$ where the tangent to the curve is horizontal.
21 Determine the coordinates of the points on the graph of $x^2 + y^2 - 4x + 6y + 12 = 0$ where the tangent to the curve is vertical.
22 If $y - y^3 = x^2 + x - 2$ determine $\frac{dy}{dx}$ and $\frac{d^2y}{dx^2}$ in terms of x and y and evaluate each of these for the point $(1, 0)$.
23 Find the equation of the tangent to the curve $x^2 = 2 \sin y$ at the point $\left(1, \frac{\pi}{6}\right)$.
24 If $y^2 + \cos x = 3y + 1$ determine $\frac{dy}{dx}$ and $\frac{d^2y}{dx^2}$ in terms of x and y .
25 If $2 \sin y - x^2 = 2x + 1$ determine $\frac{dy}{dx}$ and $\frac{d^2y}{dx^2}$ in terms of x and y and evaluate each of these for the point $\left(-2, \frac{\pi}{6}\right)$.
26 The graph on the right shows the ellipse with equation $3x^2 + y^2 = 9$
Find the coordinates of any points on the ellipse where the gradient is -1 .

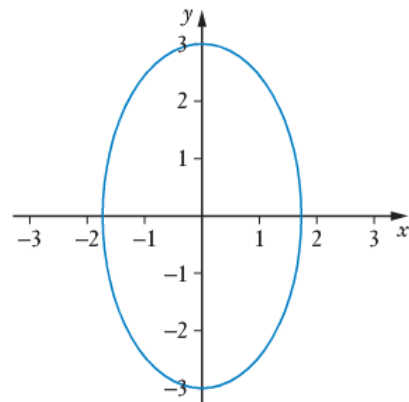

Differentiation of parametrically defined functions

Note

This topic is not specifically mentioned in the syllabus for this unit but I include it here because it is only bringing together the idea of defining a function parametrically, as encountered in Unit Three of *Mathematics Specialist*, with our ability to use the chain rule.

Consider the parametric equations $x = 3t + 1$ and $y = t^2$.

In this case we can eliminate t to express y directly in terms of x .

From the first equation: $t = \frac{x-1}{3}$

Substituting into the second equation: $y = \frac{(x-1)^2}{9}$

From which $\frac{dy}{dx} = \frac{2(x-1)}{9}$.

If we require the gradient at a particular point on the curve, say where $t = 1$, i.e. the point $(4, 1)$, then

$$\frac{dy}{dx} = \frac{2}{3}.$$

However, use of the chain rule allows this derivative to be determined without first having to eliminate the parameter. (Particularly useful for those cases in which expressing y directly in terms of x is difficult or even impossible.)

If $x = 3t + 1$ and $y = t^2$
then $\frac{dx}{dt} = 3$ and $\frac{dy}{dt} = 2t$.

Now use the chain rule: $\frac{dy}{dx} = \frac{dy}{dt} \frac{dt}{dx}$
 $= (2t) \left(\frac{1}{3} \right)$

If $t = 1$ $\frac{dy}{dx} = \frac{2}{3}$ as before.

Note: • The above example used the fact that: $\frac{dt}{dx} = \frac{1}{\left(\frac{dx}{dt}\right)}$.

We cannot simply assume this result to be true by the rules of fractions because $\frac{dt}{dx}$ is not a fraction (it is the limit of a fraction). Instead the result can be justified as follows:

Using the chain rule: $\frac{dz}{dt} \frac{dt}{dx} = \frac{dz}{dx}$ [1]

Now suppose that $z = x$. Differentiation gives $\frac{dz}{dx} = 1$.

Equation [1] then becomes $\frac{dx}{dt} \frac{dt}{dx} = 1$ and so $\frac{dt}{dx} = \frac{1}{\left(\frac{dx}{dt}\right)}$ as required.

- As was mentioned in Unit Three of *Mathematics Specialist*, some graphic calculators can accept and display relationships defined parametrically. Use such a calculator to display the graph defined parametrically as:

$$\begin{cases} x = \sin t \\ y = 2 \cos 3t \end{cases}$$

Exercise 8B

1 If $x = 3 \sin 2t$ and $y = 2 \cos 5t$ find, in terms of t ,

a $\frac{dx}{dt}$

b $\frac{dy}{dt}$

c $\frac{dy}{dx}$

2 If $x = \sin^2 t$ and $y = \cos 3t$ find, in terms of t ,

a $\frac{dx}{dt}$

b $\frac{dy}{dt}$

c $\frac{dy}{dx}$

Find $\frac{dy}{dx}$ in terms of the parameter t for each of the following.

3 $x = 2 + 3t, y = t^2$.

4 $x = t^2, y = 2 + 3t$.

5 $x = 5t^3, y = t^2 + 2t$.

6 $x = 3t^2 + 6t, y = \frac{1}{t+1}$.

7 $x = t^2 - 1, y = (t-1)^2$.

8 $x = \frac{t}{t-1}, y = \frac{2}{t+1}$.

9 Determine the gradient at the point where $t = -1$, for the curve that is defined parametrically by $x = t^2 + 2, y = t^3$.

10 Determine the gradient at the point where $t = 2$, for the curve that is defined parametrically by $x = \frac{1}{t+1}, y = t^2 + 1$.

11 Determine the coordinates, (x, y) , of any points where $\frac{dy}{dx} = 0$ on the curve defined parametrically by $x = 2t^2 + 3t, y = t^3 - 12t$.

12 The diagram on the right shows the curve defined parametrically as:

$$x = 4 \sin t, \quad y = 2 \sin 2t, \quad \text{for } 0 \leq t \leq 2\pi.$$

a Find an expression for $\frac{dy}{dx}$ in terms of t .

b Find the coordinates and the gradient at the point where $t = \frac{\pi}{6}$.

c Find the exact values of t (for $0 \leq t \leq 2\pi$) for which $\frac{dy}{dx} = 0$.

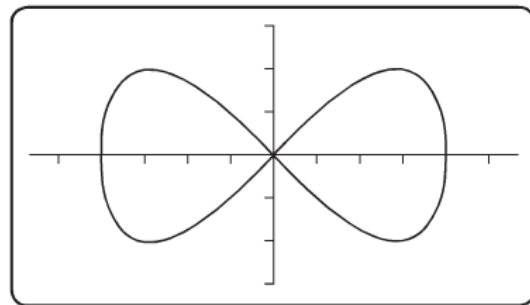

13 If $y = t + \frac{2}{t}$ and $x = 2t - \frac{1}{t}$ find a $\frac{dy}{dx}$ in terms of t ,

b $\frac{d^2y}{dx^2}$ in terms of t .

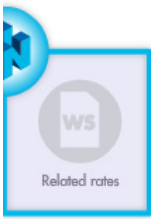

Related rates

Suppose we know the rate of change of one variable, say x , with respect to some second variable, say t . If we also know the relationship between x and some third variable, say y , then we are able to determine the rate of change of y , with respect to t .

i.e. Knowing $\frac{dx}{dt}$ and y as a function of x , we can determine $\frac{dy}{dt}$.

For example:

Suppose $\frac{dx}{dt} = 5$ and $y = 5x^2 + 2x - 3$.

$\frac{dy}{dt}$ can be obtained as follows: If $y = 5x^2 + 2x - 3$

then $\frac{dy}{dx} = 10x + 2$.

By the chain rule $\frac{dy}{dt} = \frac{dy}{dx} \frac{dx}{dt}$
 $= (10x + 2)5$
 $= 50x + 10$

Alternative setting out:

By the chain rule $\frac{dy}{dt} = \frac{d}{dt}(5x^2 + 2x - 3)$
 $= \frac{d}{dx}(5x^2 + 2x - 3) \frac{dx}{dt}$
 $= (10x + 2)5$
 $= 50x + 10$

EXAMPLE 4

If $A = 3w^2$ and $\frac{dw}{dt} = 5$ find $\frac{dA}{dt}$ when $w = 2$.

Solution

If $A = 3w^2$ then $\frac{dA}{dt} = \frac{d}{dt}(3w^2)$
 $= \frac{d}{dw}(3w^2) \frac{dw}{dt}$
 $= (6w)(5)$
 $= 30w$
 $= 60$ when $w = 2$.

Thus when $w = 2$, $\frac{dA}{dt}$ is 60.



EXAMPLE 5

If $y^2 = 1.5w^3 + 2.5$ and $\frac{dw}{dt} = 12$, find $\frac{dy}{dt}$ when $y = 2$.

Solution

$$\begin{aligned} \text{If } y^2 = 1.5w^3 + 2.5 \quad \text{then} \quad \frac{d}{dt}(y^2) &= \frac{d}{dt}(1.5w^3 + 2.5) \\ \frac{d}{dy}(y^2) \frac{dy}{dt} &= \frac{d}{dw}(1.5w^3 + 2.5) \frac{dw}{dt} \\ 2y \frac{dy}{dt} &= (4.5w^2)(12) \\ \therefore \frac{dy}{dt} &= \frac{27w^2}{y} \end{aligned}$$

$$\begin{aligned} \text{Now when } y &= 2 \\ 4 &= 1.5w^3 + 2.5 \\ \text{giving } w &= 1. \end{aligned}$$

$$\text{Thus when } y = 2, \quad w = 1 \quad \text{and} \quad \frac{dy}{dt} = \frac{27}{2}$$

Thus when $y = 2$, $\frac{dy}{dt}$ is 13.5.

EXAMPLE 6

The length of each side of a square is increased at a rate of 2 mm/s. Find the rate of increase in the area of the square when the side length is 10 cm.

Solution

Note: When the question does not specifically state what the rate is with respect to, as in this question, we assume it to be with respect to *time*.

Draw a diagram showing the situation at some general time t :

In the diagram shown, x cm is the side length at time t seconds.

Thus we are given that

$$\frac{dx}{dt} = 0.2$$

If the area at time t is A cm² then

$$A = x^2$$

Differentiating with respect to t :

$$\begin{aligned} \frac{dA}{dt} &= \frac{d}{dt}(x^2) \\ &= \frac{d}{dx}(x^2) \frac{dx}{dt} \\ &= (2x)(0.2) \\ &= 4 \end{aligned}$$

when $x = 10$.

When the side length is 10 cm, the area of the square is increasing at 4 cm²/s.

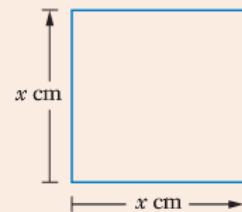

EXAMPLE 7

A particle moves in a straight line such that its velocity, v m/s, depends upon the particle's displacement, x m, from some fixed point O according to the rule

$$v = 3x + 4$$

Find the velocity and acceleration of the particle when $x = 1$.

Solution

When $x = 1$

$$\begin{aligned} v &= 3(1) + 4 \\ &= 7 \end{aligned}$$

When $x = 1$, the velocity is 7 m/s.

The acceleration is

$$\begin{aligned} \frac{dv}{dt} &= \frac{d}{dt}(3x + 4) \\ &= \frac{d}{dx}(3x + 4) \frac{dx}{dt} \\ &= (3)(v) \\ &= (3)(7) && \text{when } x = 1. \\ &= 21 \end{aligned}$$

When $x = 1$ the acceleration is 21 m/s².

EXAMPLE 8

The diagram shows a ladder AB, of length 5 metres, with its foot on horizontal ground and its top leaning against a vertical wall.

End A slips along the floor, directly away from the wall, at a speed of 0.05 m/s. How fast is end B moving down the wall at the instant that it passes through the point that is 4 m above the ground?

Solution

Draw a diagram showing the situation at some general time t :

With x and y as in the diagram $x^2 + y^2 = 25$.

Thus

$$\frac{d}{dt}(x^2 + y^2) = \frac{d}{dt}(25)$$

$$2x \frac{dx}{dt} + 2y \frac{dy}{dt} = 0$$

$$\therefore y \frac{dy}{dt} = -x \frac{dx}{dt}$$

From $x^2 + y^2 = 25$, when $y = 4$, $x = 3$. ($x = -3$ not possible in this situation).

Thus when $y = 4$

$$4 \frac{dy}{dt} = (-3)(0.05)$$

$$\therefore \frac{dy}{dt} = -0.0375$$

When B is 4 m above the ground it is moving down the wall at 0.0375 m/s.

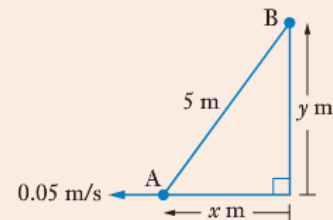
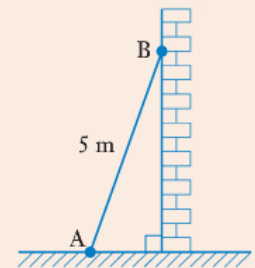

EXAMPLE 9

A person who is 1.75 m tall walks directly away from a light source positioned 5.25 m above ground.

If the person walks at a steady 1.5 m/s find

- how fast the length of the person's shadow is changing,
- how fast the tip of the person's shadow is moving across the ground.

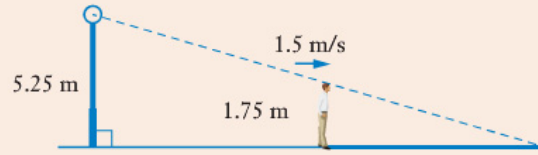

Solution

- Draw a diagram showing the situation at some general time t :

With x and y as in the diagram we are given

$$\frac{dx}{dt} = 1.5 \text{ and we require } \frac{dy}{dt}.$$

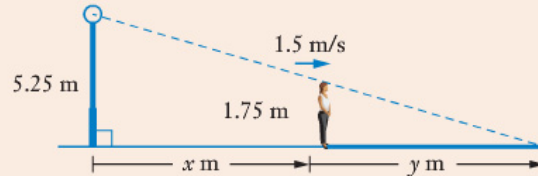

By similar triangles
$$\frac{5.25}{1.75} = \frac{x + y}{y}.$$

Which simplifies to
$$2y = x + y$$

Differentiate with respect to t :
$$\frac{d}{dt}(2y) = \frac{d}{dt}(x)$$

$$\frac{d}{dy}(2y) \frac{dy}{dt} = \frac{dx}{dt}$$

$$2 \frac{dy}{dt} = \frac{dx}{dt}$$

Thus with $\frac{dx}{dt} = 1.5$,
$$\frac{dy}{dt} = 0.75$$

The length of the person's shadow is changing at 0.75 m/s.

- The rate of change of y found in **a** will not be the rate at which the tip of the shadow is moving across the ground because we are measuring y from a moving point, the position of the person. The person is moving at 1.5 m/s and the shadow is lengthening at 0.75 m/s. Thus the tip of the shadow is moving at $(1.5 + 0.75)$ m/s.

Thus the tip of the shadow is moving across the ground at 2.25 m/s.

Alternatively we could consider the motion of the tip of the shadow by considering a variable that is measured from some fixed point. In the diagram on the right, z m is the distance from the base of the lamp post to the tip of the shadow.

We are given $\frac{dx}{dt} = 1.5$ and we require $\frac{dz}{dt}$.

By similar triangles
$$\frac{5.25}{1.75} = \frac{z}{z - x}.$$

Which simplifies to
$$2z = 3x$$

Hence
$$\frac{dz}{dt} = 1.5 \frac{dx}{dt}$$

$\therefore \frac{dz}{dt} = 1.5(1.5) = 2.25$ as before.

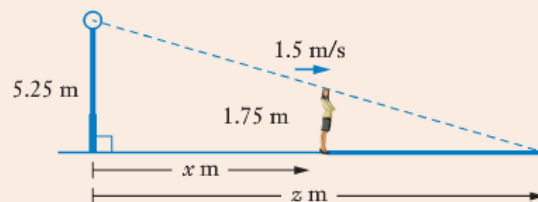

Exercise 8C

- If $y = 3x^2 + 4x$ and $\frac{dx}{dt} = 5$, find $\frac{dy}{dt}$ when $x = 6$.
- If $A = 8p^3$ and $\frac{dp}{dt} = 0.25$, find $\frac{dA}{dt}$ when $p = 0.5$.
- If $X = \sin 2p$ and $\frac{dp}{dt} = 2$, find $\frac{dX}{dt}$ when $p = \frac{\pi}{6}$.
- If $T = \frac{2\pi}{3}\sqrt{L}$ find
 - $\frac{dT}{dt}$ given that $\frac{dL}{dt} = \frac{15}{\pi}$ and $L = 100$,
 - $\frac{dL}{dt}$ given that $\frac{dT}{dt} = 6\pi$ and $L = 4$.
- If $A = \sin^2(3x)$ and $\frac{dx}{dt} = 0.1$, find $\frac{dA}{dt}$ when $x = \frac{\pi}{36}$.
- If $P = 4r^2 + 3$ and $\frac{dP}{dt} = 14$, find $\frac{dr}{dt}$ when $r = 7$.
- If $y^2 = 3x^3 + 1$ and $\frac{dx}{dt} = 0.1$, find $\frac{dy}{dt}$ when $y = 5$.
- If $x^2 + y^2 = 400$, $x \geq 0$ and $\frac{dx}{dt} = 6$, find $\frac{dy}{dt}$ when $y = 12$.

- The isosceles triangle on the right has two sides of length 10 cm and $\angle CAB$ is increasing at 0.01 radians/second, from an initial $\frac{\pi}{6}$ radians.

Find the rate of change in the area of $\triangle ABC$ at the instant when $x = \frac{\pi}{3}$.

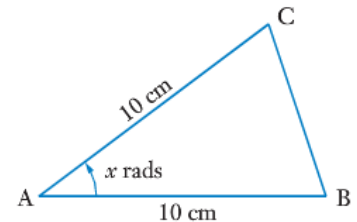

- The isosceles triangle on the right has sides AC and AB of equal length and each increasing at 0.1 cm/s from an initial 5 cm. Find the rate of change in the area of $\triangle ABC$ at the instant when $AC = AB = 10$ cm.

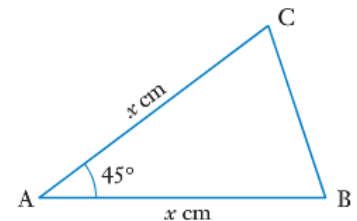

- The right triangle shown on the right has sides AB and BC able to vary in length, AC is constantly 10 cm long and $\angle ABC$ is always a right angle. Initially AB is of length 4 cm and increases at a constant rate of 0.1 cm/s.

Find the rate of change in the length of BC, 20 seconds after the increasing in the length of AB commenced.

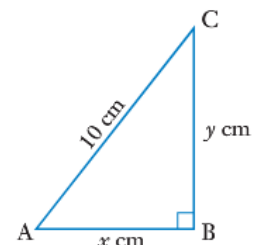

- 20** A particle moves in a straight line such that its velocity, v m/s, depends upon displacement, x m, from some fixed point O according to the rule

$$v = 2x^2 - 3$$

- Find **a** an expression in terms of x for the acceleration of the particle,
b the velocity and acceleration of the particle when $x = 2$.

- 21** At what rate is the area of an equilateral triangle increasing when each side is of length 20 cm and each is increasing at a rate of 0.2 cm/s?

- 22** A large advertising balloon is initially flat and has air pumped into it at a constant rate of $0.5 \text{ m}^3/\text{s}$, causing it to adopt a spherical shape of increasing radius.

- a** Find the rate of increase in the radius of the balloon, to the nearest cm/s, when this radius is
i 1 metre, **ii** 2 metres.
b Find the rate of increase in the radius of the balloon, to the nearest mm/s, twenty seconds after inflation commences.

- 23** The diagram shows a conical pile of sand with vertical height equal to twice the radius of the base.

Sand is being added to the pile at a rate of $0.25 \text{ m}^3/\text{minute}$ with the ratio between height and base radius being approximately maintained.

- Find **a** the rate of change in the base radius of the cone, when this radius is 2 m.
b the rate of change in the perpendicular height of the cone when this height is 2 m.

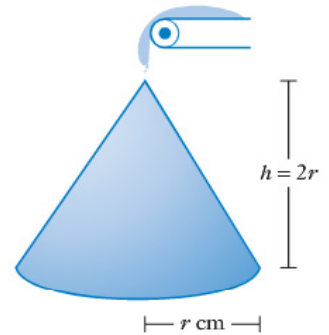

- 24** The cone shown on the right is such that the vertical section through the vertex is an equilateral triangle ABC.

The volume of the cone is increased at a constant rate of $V \text{ cm}^3/\text{s}$ with the equilateral nature of the triangular section maintained. When the base radius is 20 cm the rate of change of this radius is 0.5 cm/s. Find V correct to three significant figures.

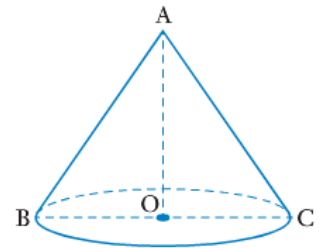

- 25** A closed cylindrical can of constant base radius 5 cm, has its height increased at 0.1 cm/s, from an initial 10 cm. Find the rate of change of **a** the external surface area,
and **b** the capacity of the can,
20 seconds after the height increase commenced.

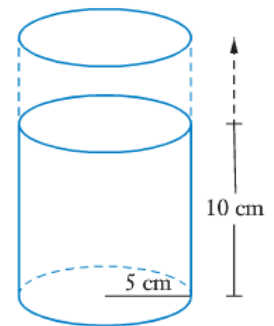

- 26** A closed cylindrical can of constant height 10 cm, has its base radius increased at 0.1 cm/s, from an initial 5 cm. Find the rate of change of **a** the external surface area, and **b** the capacity of the can, 20 seconds after the radius increase commenced.

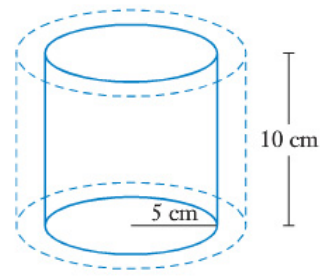

- 27** The diagram shows a ladder AB, of length 5.2 metres, with its foot on horizontal ground and its top leaning against a vertical wall. End A slips along the floor, directly away from the wall, at a speed of 0.1 m/s. How fast is end B moving down the wall at the instant that it passes through the point that is 4.8 m above the ground?

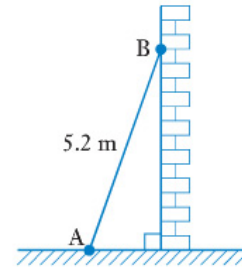

- 28** The diagram shows a hemispherical container of radius 2 metres. When the depth of the liquid in the container is h metres (see diagram), the volume of the liquid, $V \text{ m}^3$, is given by $V = \frac{\pi h^2}{3}(6 - h)$.

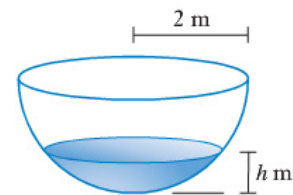

If the liquid is being pumped out of this container at a constant rate of $0.25 \text{ m}^3/\text{min}$, find the rate at which h is falling at the instant that $h = 1$. (Answer to nearest mm/min.)

- 29** The diagram shows a person of height 1.8 m walking towards a lamp post at 1.4 m/s. The light on the lamp post is 6 m above the ground.
- At what rate is the length of the person's shadow changing?
 - At what speed is the tip of the person's shadow moving across the ground?

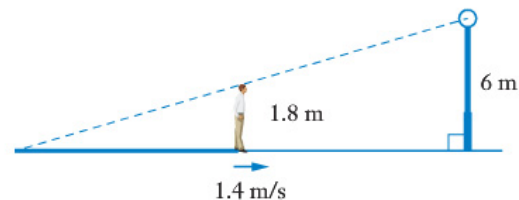

- 30** The diagram shows a person of height 1.5 m walking away from a lamp post at 2 m/s. The light on the lamp post is 4.5 m above the ground.
- At what rate is the length of the person's shadow changing?
 - At what speed is the tip of the person's shadow moving across the ground?

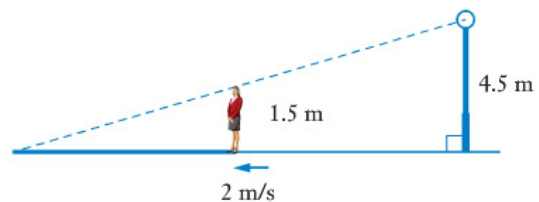

- 31** The diagram shows a hemispherical container of radius 2 metres. Water is in the container to a depth of h metres (see diagram). Water is removed from the container such that the depth of the water remaining is falling at a constant rate of 0.5 cm/s. Find the rate of change of the radius of the water surface at the instant when the depth is 1 m.

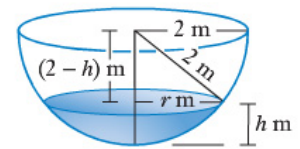

- 32** The diagram shows a model aeroplane, A, being flown in a straight line, at a constant speed of 15 m/s and constant height 20 m. The plane is radio-controlled by an enthusiast situated at point B (see diagram).

Find the rate at which the distance AB is increasing at the instant that BC (see diagram) is 48 m.

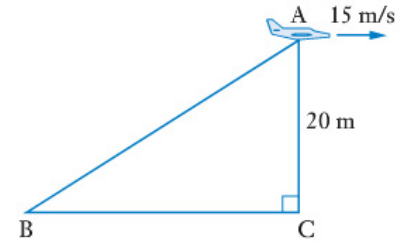

- 33** The diagram shows a loose balloon rising vertically at a constant 5 m/s, and being observed from point A on the ground, 60 metres from the point on the ground from which the balloon was released.

Find the rate of change in the distance from A to the balloon at the instant that the balloon is at a height of 80 metres.

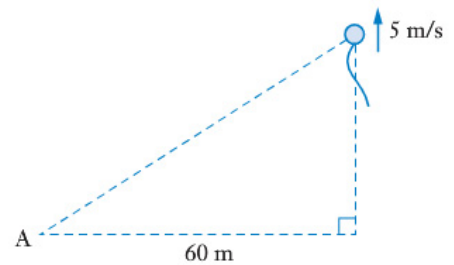

- 34** In the diagram, point L is the location of a rotating spotlight situated on the top of a police car. L is 8 metres from a straight wall and the light rotates at 2 revolutions per second (i.e. $\frac{d\theta}{dt} = 4\pi$ rad/s).

Find the speed with which the spot from the light is moving along the wall as it passes through point P which is 5 metres from the point on the wall that is closest to the light.

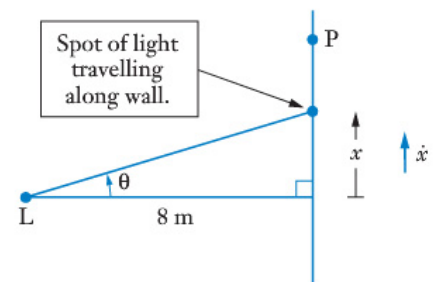

Small changes

A concept that you should be familiar with from your study of Unit Three of *Mathematics Methods*, and briefly revised here, is that if δx , the change in x , is 'small' then, δy , the corresponding small change in y is given by the **small changes** or **incremental** formula:

$$\frac{\delta y}{\delta x} \approx \frac{dy}{dx} \quad \text{i.e.} \quad \delta y \approx \frac{dy}{dx} \delta x.$$

Note

The symbol δ is a Greek letter pronounced *delta*. The capital of this letter is written Δ . In this calculus context δx is sometimes written as Δx .

EXAMPLE 10

If $f(x) = 2x^3$ use differentiation to find the approximate change in the value of the function when x changes from 10 to 10.1.

Solution

If $y = 2x^3$ then $\frac{dy}{dx} = 6x^2$ and so $\frac{\delta y}{\delta x} \approx 6x^2$
I.e. $\delta y \approx 6x^2 \delta x$
In this case $x = 10$ and $\delta x = 0.1$, thus $\delta y \approx 6 \times 10^2 \times 0.1 = 60$

When x changes from 10 to 10.1 the change in $f(x)$ is approximately 60.

(Comparing this with $f(10.1) - f(10) = 2 \times 10.1^3 - 2 \times 10^3 = 60.602$ shows the approximation reasonable.)

Marginal rates of change

For a company manufacturing x units of a particular commodity there are three important functions of x that will interest the firm.

- The cost function, $C(x)$. This is the total cost of producing x units of the commodity.
- The revenue function, $R(x)$. The total income the firm receives by selling x units.
- The profit function, $P(x)$. The total profit from the sale of x units. $P(x) = R(x) - C(x)$.

(Clearly $R(x)$, $C(x)$ and $P(x)$ only have meaning for $x \geq 0$ and for many commodities it is also the case that these functions only make sense for integer values of x .)

If δx is some small change in x and δC is the corresponding small change in the cost function then

$$\frac{dC}{dx} \approx \frac{\delta C}{\delta x}. \quad \text{Thus if } \delta x = 1, \text{ then } \frac{dC}{dx} \approx \frac{\delta C}{1}.$$

Hence $\frac{dC}{dx}$ is the approximate change in C when x changes by 1.

$\frac{dC}{dx}$ is called the **marginal cost**. Similarly $\frac{dR}{dx}$ **marginal revenue** and $\frac{dP}{dx}$ **marginal profit**.

The marginal cost, $C'(x)$, gives us the instantaneous cost per unit when the x th unit is being produced.

This is *not* the average cost per unit at that stage of the production. The average cost per unit can be obtained by dividing the total cost by the number of units, i.e. $\frac{C(x)}{x}$.

EXAMPLE 11

A manufacturer produces x items of a certain product. The cost function $C(x)$ is given in dollars by:

$$C(x) = \frac{x^3}{10} - 30x^2 + 3000x + 5000$$

Evaluate $C'(160)$ and explain what information your answer gives.

Solution

$$\text{Marginal cost} = \frac{3x^2}{10} - 60x + 3000 \quad \therefore \quad C'(160) = \$1080 \text{ per unit.}$$

When the production level reaches 160 units it will then cost approximately \$1080 to produce one more unit.

Exercise 8D

- If $f(x) = x^3 - 5x$ use differentiation to find the approximate change in the value of the function when x changes from 5 to 5.01.
Compare your answer to $f(5.01) - f(5)$.
- If $f(x) = \sin 3x$ use differentiation to find the approximate change in the value of the function when x changes from $\frac{\pi}{9}$ to $\frac{\pi}{9} + 0.01$. Compare your answer to $f\left(\frac{\pi}{9} + 0.01\right) - f\left(\frac{\pi}{9}\right)$.
- If $f(x) = 2 \sin^3 5x$ use differentiation to find the approximate change in the value of the function when x changes from $\frac{\pi}{3}$ to $\frac{\pi}{3} + 0.001$. Compare your answer to $f\left(\frac{\pi}{3} + 0.001\right) - f\left(\frac{\pi}{3}\right)$.
- The cost function, \$C\$, for producing x units of a product is given by
$$C = 5000 + 20\sqrt{x}.$$
Determine an expression for the marginal cost and hence calculate the marginal cost for
 - $x = 25$,
 - $x = 100$,
 - $x = 400$.
- The cost, \$C\$, of producing x tonnes of a particular product is given by
$$C = 15000 + 750x - 15x^2 + \frac{x^3}{10}$$
Determine an expression for the marginal cost and hence calculate the marginal cost for
 - $x = 30$,
 - $x = 60$,
 - $x = 100$.
- The cost function for a particular item is given by \$C\$ where $C = 450 + 0.5x^2$ and x is the number of such items produced.
Find the marginal cost for $x = 10$ and explain what this tells you about the cost of producing one more item at this level of production.
- The length of one edge of a cube was measured as 5 cm when it was in fact 2 mm more than this. Use differentiation to find the approximate error that using the value of 5 cm would cause in
 - the surface area of the cube (in cm^2),
 - the volume of the cube (in cm^3).

Logarithmic differentiation

We conclude this chapter on differentiation techniques and applications by considering a technique sometimes referred to as **logarithmic differentiation**. This assumes that through your study of Unit Four of *Mathematics Methods* you have encountered, and are familiar with, the idea of a logarithm, the natural logarithm $\ln x$, the laws of logarithms and that $\frac{d}{dx}(\ln f(x)) = \frac{f'(x)}{f(x)}$. If this is not the case then leave this section for now and return to it when you have covered these aspects in Unit Four of *Mathematics Methods*.

In order to differentiate some functions it can be useful to consider the logarithm of the expression to be differentiated. Taking logarithms, usually natural logarithms, gives a function defined implicitly, which we can then differentiate. The next example demonstrates its use.

EXAMPLE 12

Determine $\frac{dy}{dx}$ given that $y = 3^x$.

Solution

$$\text{If } y = 3^x \quad \text{then} \quad \ln y = \ln(3^x) \\ = x \ln 3$$

$$\text{Differentiating with respect to } x: \quad \frac{d}{dx}(\ln y) = \frac{d}{dx}(x \ln 3)$$

$$\therefore \quad \frac{d}{dy}(\ln y) \frac{dy}{dx} = \frac{d}{dx}(x \ln 3)$$

$$\text{I.e.} \quad \frac{1}{y} \frac{dy}{dx} = \ln 3$$

$$\frac{dy}{dx} = y \ln 3$$

$$\text{Therefore} \quad \frac{dy}{dx} = 3^x \ln 3$$

Exercise 8E

- 1 Show that using logarithmic differentiation to determine $\frac{dy}{dx}$ for $y = x^3(2x + 1)^5$ gives the same answer as using the product rule.
- 2 Show that using logarithmic differentiation to determine $\frac{dy}{dx}$ for $y = \frac{x^3}{x^2 + 1}$ gives the same answer as using the quotient rule.
- 3 Use logarithmic differentiation to differentiate
 - a x^x
 - b x^{2x}
 - c $x^{\cos x}$
 - d $\sqrt{\frac{3x+1}{3x-1}}$

Miscellaneous exercise eight

This miscellaneous exercise may include questions involving the work of this chapter and the ideas mentioned in the Preliminary work section at the beginning of this unit.

1 Find expressions for $\frac{dy}{dx}$ for each of the following.

a $y = \frac{2x+1}{3-2x}$

b $y = \sin^3(2x+1)$

c $3x^2y + y^3 = 5x + 7$

d $x = t^2 + 3t - 6, y = t^4 + 1$

2 Find the equation of the tangent to $x^2 + y^2 = 25$ at the point (3, 4).

3 Find an expression for $\frac{d^2y}{dx^2}$ in terms of y only, given that

a $y + 1 = xy.$

b $y^3 - 5 = xy.$

4 A rocket is launched vertically from point A, see diagram.

From a point 200 metres from A, and on the same level as A, the rocket's angle of elevation, θ , is recorded.

For the first 25 seconds from launching, the propellant in the rocket is such that the rate of change of θ with respect to time is $\frac{1}{20}$ rad/s.

Find the velocity and acceleration of the rocket when θ is

a $\frac{\pi}{6}$

b $\frac{\pi}{3}.$

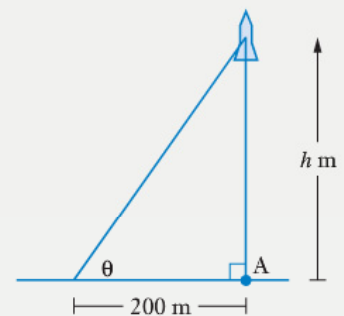

5 a If $y = (2x+3)^3$ then $x = \frac{\sqrt[3]{y}-3}{2}.$

Use the first equation to determine $\frac{d^2y}{dx^2}$ and the second to determine $\frac{d^2x}{dy^2}.$

Hence show that
$$\frac{d^2y}{dx^2} = -\frac{d^2x}{dy^2} \left(\frac{dy}{dx} \right)^3.$$

b Prove that for any $y = f(x)$, provided the necessary derivatives exist,

$$\frac{d^2y}{dx^2} = -\frac{d^2x}{dy^2} \left(\frac{dy}{dx} \right)^3.$$

9.

Integration techniques and applications

- Integration by substitution (or change of variable)
- Definite integrals and the change of variable method
- Use of trigonometric identities to assist integration
- Integration to give logarithmic functions
- More about partial fractions
- Volumes of revolution
- Rotation about the y -axis
- Numerical integration
- Extension: Integration by parts
- Miscellaneous exercise nine

EXAMPLE 1

Use the substitution $u = 2x - 3$ to determine $\int 56x(2x - 3)^5 dx$.

Solution

If $u = 2x - 3$ then $\frac{du}{dx} = 2$

$$\begin{aligned}\text{Thus } \int 56x(2x - 3)^5 dx &= \int 56x(2x - 3)^5 \frac{dx}{du} du \\ &= \int 56 \left(\frac{u+3}{2} \right) u^5 \frac{1}{2} du \\ &= \int (14u^6 + 42u^5) du \\ &= 2u^7 + 7u^6 + c \\ &= u^6(2u + 7) + c \\ &= (2x - 3)^6(4x + 1) + c\end{aligned}$$

EXAMPLE 2

Use the substitution $u = x - 2$ to determine $\int \frac{6x}{\sqrt{x-2}} dx$.

Solution

If $u = x - 2$ then $\frac{du}{dx} = 1$.

$$\begin{aligned}\text{Thus } \int \frac{6x}{\sqrt{x-2}} dx &= \int \frac{6x}{\sqrt{x-2}} \frac{dx}{du} du \\ &= \int \frac{6(u+2)}{\sqrt{u}} (1) du \\ &= \int (6u^{\frac{1}{2}} + 12u^{-\frac{1}{2}}) du \\ &= 4u^{\frac{3}{2}} + 24u^{\frac{1}{2}} + c \\ &= 4u^{\frac{1}{2}}(u + 6) + c \\ &= 4\sqrt{x-2}(x + 4) + c\end{aligned}$$

$$\int \left(\frac{6 \cdot x}{\sqrt{x-2}} \right) dx = 4 \cdot \sqrt{x-2} \cdot (x + 4)$$



Exercise 9B

Determine the following integrals using any appropriate method.

1 $\int (x + \sin 3x) dx$

2 $\int 2 dx$

3 $\int \sin 8x dx$

4 $\int (\cos x + \sin x)(\cos x - \sin x) dx$

5 $\int \frac{x^2 + x}{\sqrt{x}} dx$

6 $\int 4x \sin(x^2) dx$

7 $\int 8x \sin(x^2 - 3) dx$

8 $\int 24\sqrt{1+3x} dx$

9 $\int 15x\sqrt{1+3x} dx$

10 $\int \sin^4 2x \cos 2x dx$

11 $\int 6x(2x+7)^5 dx$

12 $\int 6(2x+7)^5 dx$

13 $\int (3x^2 - 2) dx$

14 $\int 4x(3x^2 - 2)^7 dx$

15 $\int (\cos x + \sin 2x) dx$

16 $\int 6x(3x-2)^7 dx$

17 $\int x dx$

18 $\int \frac{6}{\sqrt{1+2x}} dx$

19 $\int \frac{6x}{\sqrt{1+2x}} dx$

20 $\int (x^2 + x + 1)^8 (2x + 1) dx$

21 $\int 24x \sin(x^2 + 3) dx$

22 $\int (2x+1)\sqrt[3]{x-5} dx$

23 $\int \frac{(\sqrt{x} + 5)^5}{\sqrt{x}} dx$

24 $\int 4(2x-1)^5 dx$

25 $\int 4x(2x-1)^5 dx$

26 $\int \cos^3 6x \sin 6x dx$

27 $\int \frac{6x}{\sqrt{x^2-3}} dx$

28 $\int \sin 2x \cos 2x dx$

29 $\int 8x^2(2x-1)^5 dx$

Exercise 9C

Determine the following definite integrals using the suggested substitution and showing full algebraic reasoning. Confirm each answer using a graphic calculator.

1 $\int_0^1 16(2x+1)^3 dx, \quad u = 2x+1$

2 $\int_0^1 16x(2x+1)^3 dx, \quad u = 2x+1$

3 $\int_0^1 \frac{6x}{25}(x+5)^4 dx, \quad u = x+5$

4 $\int_0^{\frac{\pi}{2}} 12 \sin^5 x \cos x dx, \quad u = \sin x$

5 $\int_2^6 \frac{3x}{\sqrt{5x+6}} dx, \quad u = 5x+6$

6 $\int_2^5 \frac{x+3}{\sqrt{x-1}} dx, \quad u = x-1$

7 The graph on the right is that of the function

$$y = \frac{4}{\sqrt{2x+1}}.$$

Performing any integration using the substitution $u = 2x+1$, determine the area under the curve from $x = 0$ to $x = 4$.

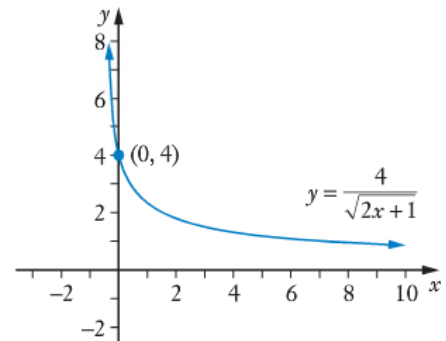

8 The graph on the right is that of the function

$$y = 6x(x-3)^3.$$

Performing any integration using the substitution $u = x-3$, determine the area enclosed by the curve and the x -axis.

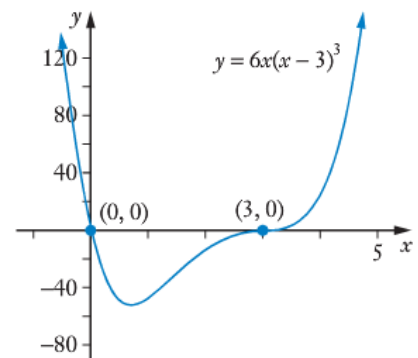



Use of trigonometric identities to assist integration

Some integrations are best performed by first rearranging the function to be integrated using some of the trigonometric identities we were reminded of in the *Preliminary work* section at the beginning of this unit. The examples that follow demonstrate such use.

In particular, note carefully the techniques for finding the antiderivatives of

$$\sin^n x \text{ and } \cos^n x$$

as demonstrated in example 4, for **when n is odd**, and the technique ensures that some terms of the form $f'(x)[f(x)]^k$ arise,

and in example 5, for **when n is even**, and the technique uses the trigonometric identity $\cos 2x = 2 \cos^2 x - 1$, rearranged as $\cos^2 x = \frac{1 + \cos 2x}{2}$.

EXAMPLE 4

Find the antiderivative of $\sin^5 x$.

Solution

$$\begin{aligned} \sin^5 x &= (\sin x)(\sin^4 x) \\ &= (\sin x)(1 - \cos^2 x)^2 \\ &= (\sin x)(1 - 2 \cos^2 x + \cos^4 x) \\ &= \sin x - 2 \sin x \cos^2 x + \sin x \cos^4 x \end{aligned}$$

To find the antiderivative, try $y = \cos x + \cos^3 x + \cos^5 x$

then $\frac{dy}{dx} = -\sin x - 3 \cos^2 x \sin x - 5 \cos^4 x \sin x$

Thus if $y = -\cos x + \frac{2}{3} \cos^3 x - \frac{1}{5} \cos^5 x$

then, as required, $\frac{dy}{dx} = \sin x - 2 \sin x \cos^2 x + \sin x \cos^4 x$.

The required antiderivative is $-\cos x + \frac{2}{3} \cos^3 x - \frac{1}{5} \cos^5 x + c$.

Does your calculator give this answer when asked for $\int \sin^5 x \, dx$?

If it gives an answer that looks different to that shown above are they in fact equivalent? Investigate.



EXAMPLE 5

Find the antiderivative of $\cos^4 x$.

Solution

$$\begin{aligned}\cos^4 x &= (\cos^2 x)^2 \\ &= \left(\frac{1 + \cos 2x}{2}\right)^2 \\ &= \frac{1}{4} + \frac{2 \cos 2x}{4} + \frac{\cos^2 2x}{4} \\ &= \frac{1}{4} + \frac{\cos 2x}{2} + \frac{1 + \cos 4x}{8} \\ &= \frac{3}{8} + \frac{\cos 2x}{2} + \frac{\cos 4x}{8}\end{aligned}$$

The required antiderivative is $\frac{3}{8}x + \frac{\sin 2x}{4} + \frac{\sin 4x}{32} + c$.

Again check to see if this is what your calculator gives when asked for $\int \cos^4 x \, dx$.

EXAMPLE 6

Use the fact that

$$\sin A \cos B = \frac{1}{2} [\sin(A + B) + \sin(A - B)]$$

to determine

$$\int \sin 5x \cos 3x \, dx$$

Solution

$$\begin{aligned}\sin 5x \cos 3x &= \frac{1}{2} [\sin(5x + 3x) + \sin(5x - 3x)] \\ &= \frac{1}{2} \sin(8x) + \frac{1}{2} \sin(2x)\end{aligned}$$

Thus

$$\begin{aligned}\int \sin 5x \cos 3x \, dx &= \int \frac{1}{2} \sin(8x) \, dx + \int \frac{1}{2} \sin(2x) \, dx \\ &= -\frac{1}{16} \cos(8x) - \frac{1}{4} \cos(2x) + c\end{aligned}$$



Find the antiderivative of each of the following.
(Note: Not all of the expressions need rearranging.)

3 $\sin^4 x \cos x$

4 $6 \sin^3 x \cos x$

5 $\sin^3 x$

6 $\cos^3 x$

7 $\cos^5 x$

8 $\cos^2 x$

9 $\sin^2 x$ (Hint: $\cos 2A = 1 - 2 \sin^2 A$.)

10 $8 \sin^4 x$

11 $\cos^2 x + \sin^2 x$

12 $\cos^2 x - \sin^2 x$

13 $\sin^3 x + \cos^2 x$

14 $2 \sin x \cos x$

15 $\sin^3 x \cos^2 x$

16 $\cos^3 x \sin^2 x$

17 $\tan^2 3x$

18 $1 + \tan^2 x$

19 $\frac{\sin x}{1 - \sin x} \times \frac{\sin x}{1 + \sin x}$

20 $\sec^2 x \tan^4 x$

21 The graph shown below shows the function $y = x + \cos^2 x - \sin^2 x$, for $-\pi \leq x \leq 3\pi$.

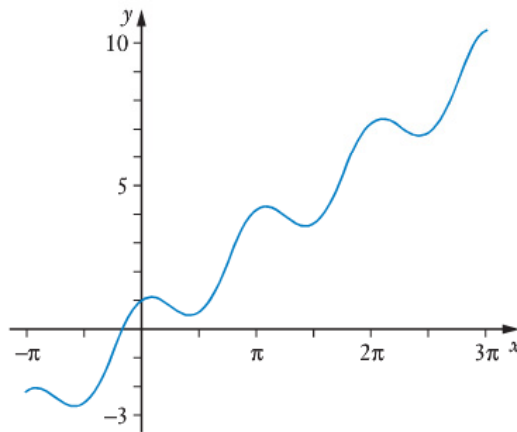

Determine the area under the curve $y = x + \cos^2 x - \sin^2 x$ from $x = 0$ to $x = 2\pi$.

22 A particle moves such that its velocity vector, \mathbf{v} m/s, at time t seconds is given by

$$\mathbf{v} = 4 \sin^2 t \mathbf{i} + \tan^2 t \mathbf{j} \quad \left(0 \leq t \leq \frac{\pi}{2}\right).$$

Find **a** an expression for the position vector of the particle, $\mathbf{r}(t)$ metres, at time t seconds given that when $t = 0$, $\mathbf{r} = 3\mathbf{i} + \mathbf{j}$.

b the position vector of the particle when $t = \frac{\pi}{4}$.

EXAMPLE 8

Find each of the following integrals.

a $\int \frac{14}{2x-1} dx$

b $\int \frac{6x}{x^2+1} dx$

Solution

- a** Noticing that the numerator is a scalar multiple of the derivative of the denominator, we expect the answer to involve $\ln|2x-1|$.

$$\int \frac{14}{2x-1} dx = 7 \ln|2x-1| + c. \quad (\text{See first note below.})$$

- b** Noticing that the numerator is a scalar multiple of the derivative of the denominator we expect the answer to involve $\ln|x^2+1|$.

$$\int \frac{6x}{x^2+1} dx = 3 \ln|x^2+1| + c. \quad (\text{See second note below.})$$

Note • Using logarithmic laws we could write the answer to part **a** as follows:

$$\begin{aligned} 7 \ln|2x-1| + c &= 7 \ln(2|x-0.5|) + c \\ &= 7 \ln 2 + 7 \ln|x-0.5| + c \\ &= 7 \ln|x-0.5| + \text{a constant.} \end{aligned}$$

- With (x^2+1) positive for all x the answer to part **b** could be written simply as $3 \ln(x^2+1) + c$.

EXAMPLE 9

Find each of the following definite integrals.

a $\int_2^3 \frac{1}{x} dx$

b $\int_{-3}^{-2} \frac{1}{x} dx$

Solution

a $\int_2^3 \frac{1}{x} dx = [\ln|x|]_2^3$
 $= \ln 3 - \ln 2$
 $= \ln 1.5$

b $\int_{-3}^{-2} \frac{1}{x} dx = [\ln|x|]_{-3}^{-2}$
 $= \ln 2 - \ln 3$
 $= -\ln 1.5$

Note • That the part **b** answer above is the negative of the part **a** answer should come as no surprise when we consider the graph of $y = \frac{1}{x}$.

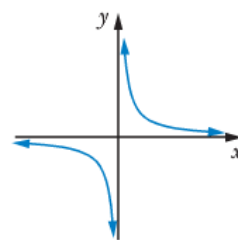

- Definite integrals of the form $\int_a^b \frac{f'(x)}{f(x)} dx$ are undefined if, for some value of x in the interval $a \leq x \leq b$, $f(x) = 0$.

For example: $\int_{-1}^2 \frac{1}{x} dx$ is undefined. $\int_2^5 \frac{1}{(x^2 - 2x - 3)} dx$ is undefined.

How does your calculator respond when asked to find these definite integrals?

EXAMPLE 10

Find each of the following integrals.

a $\int \frac{2x}{x+1} dx$

b $\int \frac{2x+5}{x(x+1)} dx$

Solution

- a** First rearrange the improper fraction:

$$\begin{aligned} \frac{2x}{x+1} &= \frac{2(x+1) - 2}{x+1} \\ &= 2 - \frac{2}{x+1} \end{aligned}$$

Thus
$$\begin{aligned} \int \frac{2x}{x+1} dx &= \int 2 dx - \int \frac{2}{x+1} dx \\ &= 2x - 2 \ln|x+1| + c. \end{aligned}$$

- b** First express $\frac{2x+5}{x(x+1)}$ in what we call **partial fractions**, as shown below.

We write
$$\begin{aligned} \frac{2x+5}{x(x+1)} &= \frac{A}{x} + \frac{B}{x+1} \\ &= \frac{A(x+1) + Bx}{x(x+1)} \end{aligned}$$

Hence
$$2x + 5 = A(x+1) + Bx$$

from which
$$2 = A + B \quad \text{and} \quad 5 = A.$$

Thus
$$A = 5 \quad \text{and} \quad B = -3.$$

$$\begin{aligned} \int \frac{2x+5}{x(x+1)} dx &= \int \frac{5}{x} dx - \int \frac{3}{x+1} dx \\ &= 5 \ln|x| - 3 \ln|x+1| + c. \end{aligned}$$





More about partial fractions

When expressing an algebraic fraction as partial fractions (as in part **b** of the previous example) the procedure, and the expression we use, depends on the nature of the initial fraction.

- If the fraction is improper, i.e. if the order of the numerator is equal to or greater than the order of the denominator, rearrange the fraction. (As in part **a** of the previous example.)

Now that the only fractions are 'proper' consider the nature of the denominator:

- Denominator has linear factors.

For example $\frac{4x-3}{(x+3)(2x+1)}$. Use $\frac{A}{(x+3)} + \frac{B}{(2x+1)}$.

- Denominator with a quadratic factor (that does not factorise).

For example $\frac{7x^2-2x+5}{(x-1)(x^2+1)}$. Use $\frac{A}{(x-1)} + \frac{Bx+C}{(x^2+1)}$.

- Denominator with a repeated linear factor.

For example $\frac{2(3x^2+3x-10)}{(x+3)(x-1)^2}$. Use $\frac{A}{(x+3)} + \frac{B}{(x-1)} + \frac{C}{(x-1)^2}$.

$$\left[\text{We do not need a } \frac{Cx+D}{(x-1)^2} \text{ term because } \frac{Cx+D}{(x-1)^2} = \frac{C(x-1)+C+D}{(x-1)^2} = \frac{C}{(x-1)} + \frac{C+D}{(x-1)^2} \right]$$

Some calculators can express fractions in terms of partial fractions, as the display on the right suggests.

Try to obtain these same results yourself, algebraically, using the methods outlined above.

Thus $\int \frac{4x-3}{(x+3)(2x+1)} dx = -\ln|2x+1| + 3\ln|x+3| + c.$

$$\int \frac{7x^2-2x+5}{(x-1)(x^2+1)} dx = \ln(x^2+1) + 5\ln|x-1| + c.$$

$$\int \frac{2(3x^2+3x-10)}{(x+3)(x-1)^2} dx = \ln|x+3| + 5\ln|x-1| + \frac{2}{(x-1)} + c.$$

$$\text{expand}\left(\frac{4x-3}{(x+3)(2x+1)}, x\right) \\ \frac{-2}{(2 \cdot x + 1)} + \frac{3}{(x+3)}$$

$$\text{expand}\left(\frac{7x^2-2x+5}{(x-1)(x^2+1)}, x\right) \\ \frac{2 \cdot x}{x^2+1} + \frac{5}{x-1}$$

$$\text{expand}\left(\frac{2(3x^2+3x-10)}{(x+3)(x-1)^2}, x\right) \\ \frac{1}{x+3} + \frac{5}{x-1} - \frac{2}{(x-1)^2}$$



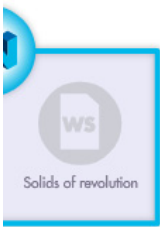

Volumes of revolution

Suppose that we take the area under $y = f(x)$, from $x = a$ to $x = b$, and rotate it about the x -axis one complete revolution (see diagram).

How could we determine the volume of the solid so formed?

The answer is to approach the problem in the same way as we did when considering area: divide the shape up into a large number of pieces each of thickness δx .

One such piece is shown in the diagram on the right.

This will be, approximately, a circular disc of thickness δx and radius y . Hence its volume $\approx \pi y^2 \delta x$.

$$\begin{aligned} \text{Thus, total volume} &= \lim_{\delta x \rightarrow 0} \sum_{x=a}^{x=b} \pi y^2 \delta x \\ &= \int_a^b \pi y^2 dx \end{aligned}$$

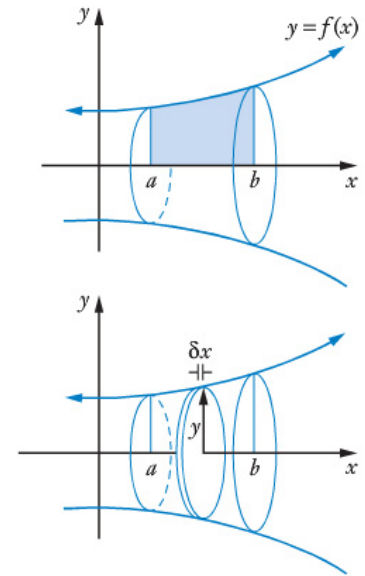

EXAMPLE 11

Find the volume of the solid formed when the area enclosed by the curve $y = x^2$, the x -axis and the line $x = 3$ is rotated through one revolution about the x -axis.

Solution

The solid involved can be seen in the diagram:

$$\begin{aligned} \text{Required volume} &= \int_0^3 \pi y^2 dx \\ &= \int_0^3 \pi (x^2)^2 dx \\ &= \int_0^3 \pi x^4 dx \\ &= \frac{243\pi}{5} \text{ units}^3 \end{aligned}$$

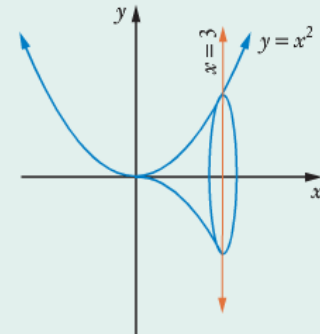

(Does your calculator have any built-in routines for such a calculation? Investigate.)

Rotation about the y -axis

To determine the volume of an object formed by rotating an area made with the y -axis, about the y -axis, we again consider a small circular disc, this time of thickness δy and radius x , see diagram.

$$\begin{aligned} \text{Required volume} &= \lim_{\delta y \rightarrow 0} \sum_{y=a}^{y=b} \pi x^2 \delta y \\ &= \int_a^b \pi x^2 dy \end{aligned}$$

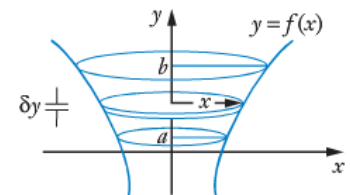

- 13** By considering the rotation of the area enclosed between $y = \sqrt{r^2 - x^2}$ and the x -axis use calculus to determine the formula for the volume of a sphere of radius r .

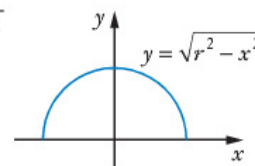

- 14** The diagram on the right shows a straight line passing through $(0, 0)$ and (h, r) . By considering the rotation of the area between this line and the x -axis for $0 \leq x \leq h$ determine the formula for the volume of a right cone of perpendicular height h and base radius r .

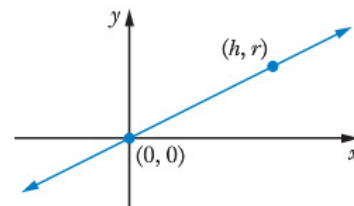

- 15** Find the volume of the solid formed when the area lying in the first quadrant and enclosed by $y = x^2$, the line $y = 2$ and the y -axis, is rotated through one revolution about the y -axis.

- 16** Use calculus to determine the exact volume of the solid formed when the area between $y = x\sqrt{5}$ and the y -axis, from $y = 1$ to $y = 2$, is rotated through 360° about the y -axis.

Check your answer using the fact that a right cone of perpendicular height h and base radius r has a volume given by $\frac{\pi r^2 h}{3}$.

- 17** The diagram on the right shows the cross-section of a bowl made by rotating about the y -axis that part of the curve $y = x^2 - 3$ that lies between the x -axis and the line $y = 12$. Neglecting the thickness of the material determine the capacity of the bowl if on each axis 1 unit represents 1 centimetre.

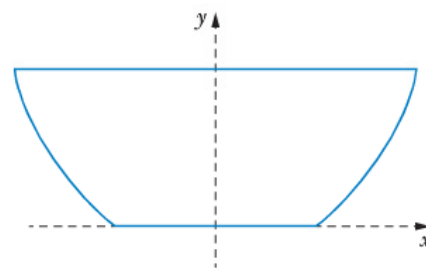

- 18** A machine component is modelled on computer by rotating for one revolution about the x -axis the area in the first quadrant enclosed by the x -axis for $0 \leq x \leq 1$, $y = \sqrt{x}$, $y = \sqrt{x-1}$ and $x = 4$. Determine the volume of the solid so formed.

- 19** The team designing the nose cone of a small space probe are considering two possibilities.

In one possibility the area between $y = \frac{\sin x}{2}$ and the x -axis, from $x = 0$ to $x = \frac{\pi}{2}$, is rotated one revolution about the x -axis to give the desired shape.

The other possibility rotates the area between $y = \sqrt{\frac{x}{2\pi}}$ and the x -axis from $x = 0$ to $x = \frac{\pi}{2}$ one revolution about the x -axis to give the desired shape.

If one unit on each axis is 1 metre determine the *exact* volume of each design.

20 A 'paraboloid' is formed by revolving a parabola, $y = kx^2$, about its axis of symmetry. The paraboloid is bounded by a plane cutting the axis of symmetry perpendicularly at the point $(0, 20)$. The intersection of this plane and the paraboloid is a circle of radius 4 units. Determine the volume of the paraboloid.

21 Area made with the x -axis, rotated about the y -axis

By considering the rotation of a small rectangle of thickness δx , height y and located a distance x from the y -axis, find a formula involving a definite integral for the volume of the solid formed by rotating the shaded area shown in the diagram one revolution about the y -axis.

Hence determine the volume of the solids obtained by rotating each of the following shaded areas about the y -axis.

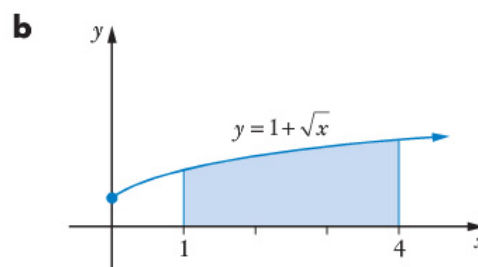
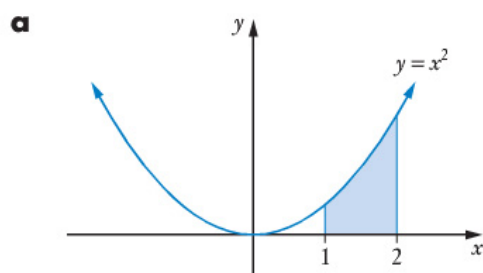
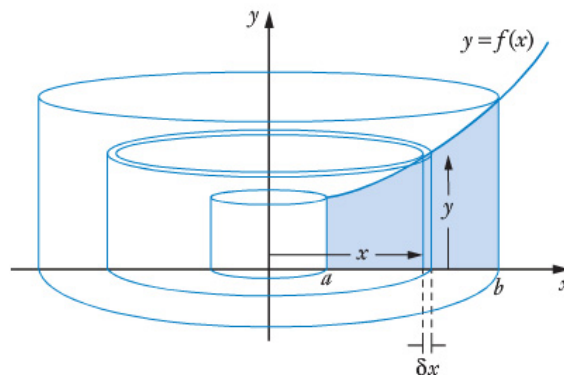

22 Area made with the y -axis, rotated about the x -axis

By considering the rotation of a small rectangle of thickness δy , length x and located a distance y from the x -axis, find a formula involving a definite integral for the volume of the solid formed by rotating the shaded area shown in the diagram one revolution about the x -axis.

Hence determine the volume of the solids obtained by rotating each of the following shaded areas about the x -axis.

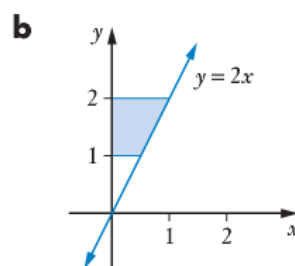
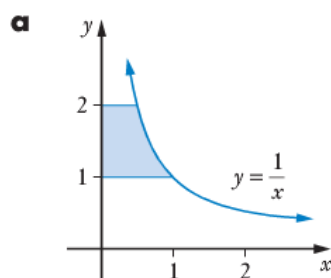
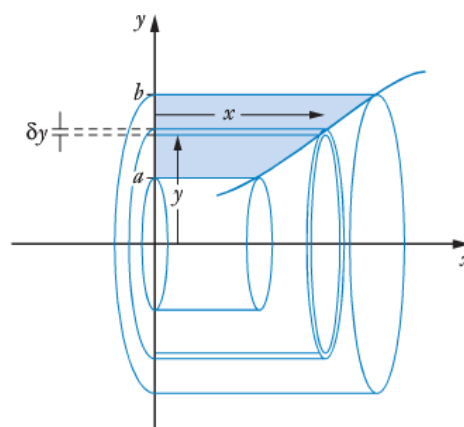

Numerical integration

Although, at this stage of the course, we are now able to integrate many functions using suitable substitutions, partial fractions or just with our knowledge of antidifferentiation, it would be quite wrong to assume that we are now able to algebraically integrate any function we might be given. Consider, for example,

$$\int \ln x \, dx, \quad \int e^x \sin x \, dx, \quad \int e^{x^2} \, dx.$$

The first two of these can in fact be reasonably easily integrated using a method called *integration by parts*, which features as an extension activity at the end of this chapter. However not all functions can be algebraically integrated and the third example above is one such case. Faced with the task of determining a definite integral for such a function, we can fall back on the basic definition of integration as the limit of a sum and obtain an approximate answer *numerically*. Hence the title of this section, **numerical integration**.

Asked to evaluate $\int_0^2 e^{x^2} \, dx$, for example, our calculator uses such a numerical method to determine an answer.

$$\int_0^2 e^{x^2} \, dx$$

16.45262777

Suppose we want to determine $\int_a^b f(x) \, dx$, and $f(x)$ is not easily integrated algebraically.

We could divide the area under $y = f(x)$, from $x = a$ to $x = b$, into a number of equal width trapezoidal strips and sum the areas.

The diagram on the right shows 4 such strips.

$$\begin{aligned} \text{Area} &= h \left[\frac{y_0 + y_1}{2} + \frac{y_1 + y_2}{2} + \frac{y_2 + y_3}{2} + \frac{y_3 + y_4}{2} \right] \\ &= \frac{1}{2} h [y_0 + 2y_1 + 2y_2 + 2y_3 + y_4] \end{aligned}$$

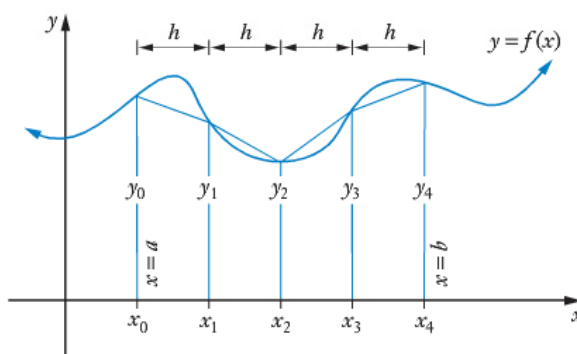

For the general case, with n strips, this trapezoidal approach gives the **trapezium rule**, or **trapezoidal rule**:

$$\int_a^b f(x) \, dx \approx \frac{1}{2} h [y_0 + 2y_1 + 2y_2 + \dots + 2y_{n-1} + y_n]$$

where $y_0 = f(x_0) = f(a)$, $y_n = f(x_n) = f(b)$ and $h = \frac{b-a}{n}$.

Another method is to model the top of each strip as being parabolic in shape. Using an even number of such strips this gives **Simpson's rule**:

$$\int_a^b f(x) \, dx \approx \frac{1}{3} h [y_0 + 4y_1 + 2y_2 + 4y_3 + 2y_4 + \dots + 2y_{n-2} + 4y_{n-1} + y_n]$$

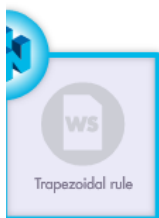

Applying the trapezium rule, with $n = 4$, to estimate $\int_0^2 e^{-x^2} dx$:

$$\int_0^2 e^{-x^2} dx \approx \frac{1}{2} \times 0.5 \times [y_0 + 2y_1 + 2y_2 + 2y_3 + y_4] \quad \text{with } y_0 = e^{0^2}, y_1 = e^{0.5^2},$$

$$\approx 20.64 \quad y_2 = e^{1^2}, y_3 = e^{1.5^2}, y_4 = e^{2^2}.$$

Using Simpson's rule:

$$\int_0^2 e^{-x^2} dx \approx \frac{1}{3} \times 0.5 \times [y_0 + 4y_1 + 2y_2 + 4y_3 + y_4]$$

$$\approx 17.35$$

Neither of the above estimates are particularly close to the calculator value given on the previous page, but then we have only used four strips. If instead we considered twenty strips, and used a computer spreadsheet to assist us:

	A	B	C	D	E	F	G	H	I
1					x	y			
2	a	0		0	0	1			
3	b	2		1	0.1	1.01005017			
4	n	20		2	0.2	1.04081077			
5	h	0.1		3	0.3	1.09417428			
6				4	0.4	1.17351087			
7				5	0.5	1.28402542			
8				6	0.6	1.43332941			
9				7	0.7	1.63231622			
10				8	0.8	1.89648088			
11				9	0.9	2.24790799			
12				10	1	2.71828183			
13				11	1.1	3.35348465			
14				12	1.2	4.22069582			
15				13	1.3	5.41948071			
16				14	1.4	7.09932707			
17				15	1.5	9.48773584			
18				16	1.6	12.9358173			
19				17	1.7	17.9933096			
20				18	1.8	25.5337217			
21				19	1.9	36.9660528		By Trapezium Rule	16.6339588
22				20	2	54.59815		By Simpson's Rule	16.4552084

Use a computer spreadsheet to estimate definite integrals, using the trapezium rule and Simpson's rule, for other functions. Then compare your approximation to that given by your calculator.

Are there any online calculators for the trapezium rule (trapezoidal rule) and Simpson's rule? Investigate.

The trapezium rule and Simpson's rule are not the only rules available for numerical integration. Do some research on the internet to investigate the midpoint rule, the Newton-Cotes rules and others.

Extension: Integration by parts

According to the product rule $\frac{d}{dx}(uv) = v \frac{du}{dx} + u \frac{dv}{dx}$.

Integrating with respect to x : $uv = \int v \frac{du}{dx} dx + \int u \frac{dv}{dx} dx$

Rearranging gives

$$\int u \frac{dv}{dx} dx = uv - \int v \frac{du}{dx} dx$$

This is the formula for *integration by parts*.

EXAMPLE

Use integration by parts to determine $\int xe^x dx$.

Solution

Let $u = x$ and $\frac{dv}{dx} = e^x$

then $\frac{du}{dx} = 1$ and $v = e^x$

Using $\int u \frac{dv}{dx} dx = uv - \int v \frac{du}{dx} dx$

$$\begin{aligned}\therefore \int xe^x dx &= xe^x - \int e^x(1) dx \\ &= xe^x - e^x + c\end{aligned}$$

Note that when determining v from $\frac{dv}{dx}$ we said $v = e^x$. What about the constant? Would our answer have been different had we used $v = e^x + k$?

Exercise

Use integration by parts to determine each of the following integrals.

1 $\int x \sin x dx$

2 $\int x \cos x dx$

3 $\int 3x \sin 2x dx$

4 $\int xe^{2x} dx$

5 $\int x^2 \ln x dx$

6 $\int x(x+2)^5 dx$

7 $\int x\sqrt{2x+1} dx$

8 $\int x^2 e^x dx$

9 $\int x^2 \sin x dx$

10 $\int 2x^3 e^{x^2} dx$

Now try the following 'sneaky' ones, again using integration by parts.

11 $\int \ln x dx$ (Yes it can be done by parts.)

12 $\int e^x \sin x dx$

13 $\int e^x \cos 2x dx$



- 13** The length of a particular rectangle is four times its width and this ratio is maintained as the width is increased at 2 mm/s. Find the rate of increase in the area of the rectangle when the width is 15 cm.

- 14** The area of the quarter circle shown shaded on the right is given by $\int_0^5 \sqrt{25-x^2} dx$.

Use the substitution $x = 5 \sin u$ to evaluate this definite integral exactly and show that your answer is consistent with the area of a circle of radius r being πr^2 .

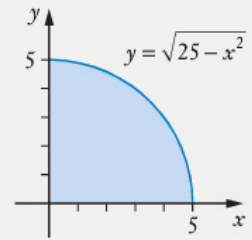

- 15** Showing full algebraic reasoning, determine the following definite integral giving your answer as an exact value.

$$\int_1^2 \frac{3x^2 + 5x - 1}{(x+2)(x+1)^2} dx$$

- 16** The diagram shows a funnel in the shape of an upturned cone of height 20 cm and 'base' radius 5 cm.

If water flows out of the funnel at $5 \text{ cm}^3/\text{s}$, how fast is the water level falling at the instant that the water in the cone has a depth of 10 cm?

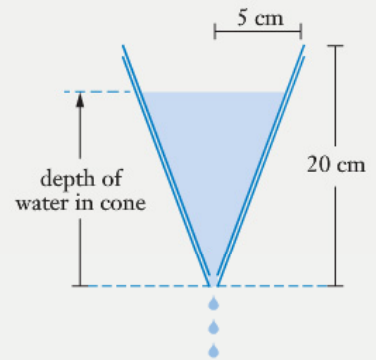

- 17** The diagram shows a person of height 1.95 m standing 24 metres due east of a lamp post that holds a light that is 4.2 m above the ground.

If the person runs at 5 m/s, find how fast the length of the person's shadow is changing 2 seconds later if the direction in which the person runs is

- a** due east,
- b** due west,
- c** due north.

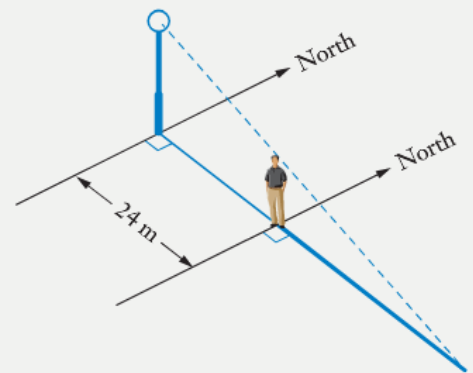

10.

Differential equations

- Differential equations
- Differential equations of the form $\frac{dA}{dt} = kA$, or $\dot{x} = kx$
- The logistic model for growth
- Can we get some idea of what the relationship between x and y will look like from the differential equation directly, without integrating?
- Slope fields
- Euler's method
- Miscellaneous exercise ten

As suggested on the previous page, you should have managed the first situation from your work on growth and decay in *Mathematics Methods Unit Three*.

With the second situation, did the fact that having differentiated y with respect to x and still having y in the answer make you think that y could be an exponential function (because they differentiate to expressions involving themselves)?



Differential equations

Any equation that involves one or more derivatives, e.g. $\frac{dy}{dx}$, $\frac{dp}{dt}$, $\frac{dv}{dp}$, $\frac{d^2y}{dx^2}$ etc, is called a **differential equation**.

The highest **order** of derivative featured gives the **order** of the differential equation.

For example, $\frac{dy}{dx} = 2x + 3$ is a first order differential equation.

To *solve* a differential equation we must find a relationship between the variables involved, that satisfies the differential equation, but that does not contain any derivatives.

To solve $\frac{dy}{dx} = 2x + 3$ we integrate both sides with respect to x .

This gives $y = x^2 + 3x + c$

Note

Integrating both sides will allow us to solve any differential equation that is of the form

$$f(y) \frac{dy}{dx} = g(x)$$

(or that can be expressed in that form).

For example, to solve $y \frac{dy}{dx} = 4x + 1$ we integrate both sides with respect to x :

$$\int y \frac{dy}{dx} dx = \int (4x + 1) dx$$

i.e. $\int y dy = \int (4x + 1) dx$

$$\therefore \frac{y^2}{2} = 2x^2 + x + c$$

- Note
- The reader should confirm that differentiating this equation with respect to x does give the original differential equation.
 - With the '+ c ' involved we have found the *family* of solutions to the differential equation. We call this the **general solution**. Given more information that allows ' c ' to be determined, we can find a **particular solution**, as the next example will show.

Exercise 10A

Find general solutions for each of the following differential equations.

1 $\frac{dy}{dx} = 8x - 5$

2 $\frac{dy}{dx} = 6\sqrt{x}$

3 $8y \frac{dy}{dx} = 4x - 1$

4 $3y \frac{dy}{dx} = \frac{5}{x^2}$

5 $14x^2y \frac{dy}{dx} = 1$

6 $4x^2 \sin 2y \frac{dy}{dx} = 5$

7 $\frac{dy}{dx} = \frac{(8x+1)}{2y-3}$

8 $\frac{dy}{dx} = \frac{x(2-3x)}{4y-5}$

9 $x^2 \frac{dy}{dx} = \frac{1}{\cos y}$

10 $(y^2+1)^5 \frac{dy}{dx} = \frac{x}{2y}$

11 Solve $\frac{dy}{dx} = 6x$, given that when $x = -1, y = 4$.

12 Solve $6x^2y \frac{dy}{dx} = 5$, given that when $x = 0.5, y = 1$.

13 Solve $(2 + \cos y) \frac{dy}{dx} = 2x + 3$, given that when $x = 1, y = \frac{\pi}{2}$.

14 Solve $\frac{dy}{dx} = \frac{4x(x^2+2)}{2y+3}$, given that when $x = 1, y = 2$.

15 Let us suppose that an object is moving such that its speed, v metres/second ($v \geq 0$), when distance s metres from an origin ($s \geq 0$), is such that

$$v \frac{dv}{ds} = 6s^2.$$

If $v = 6$ when $s = 2$, find v when $s = 3$.

16 A particular curve is such that $\frac{dy}{dx} = -\frac{\sin x}{y}$.

The curve passes through the point $\left(\frac{\pi}{3}, 2\right)$.

a If point A, (π, a) , $a > 0$, lies on the curve find a .

b If point B, $\left(\frac{\pi}{6}, b\right)$, $b > 0$, lies on the curve find b and the gradient of the curve at point B.

17 An experiment involves pumping air into a hollow rubber sphere using a machine that responds to the increasing pressure in the sphere by decreasing the amount of air it delivers. Indeed, if the sphere has an initial volume of 20 cm^3 , then its volume, $V \text{ cm}^3$, t seconds later is such that

$$\frac{dV}{dt} = \frac{25}{2V}.$$

a Find the volume of the sphere when $t = 20$.

b If pumping ceases when $V = 40$ find the value of t when this occurs.

Exercise 10B

For questions **1**, **2** and **3** give answers to the nearest whole number.

(The above statement is made to enable you to check your answers, thus confirming correct method. However you might like to consider what more appropriate rounding would be for each of these questions, given the data supplied.)

1 If $\frac{dA}{dt} = 1.5A$, $A > 0$, and $A = 100$ when $t = 0$, find A when

a $t = 1$,

b $t = 5$.

2 If $\frac{dP}{dt} = 0.25P$, $P > 0$, and $P = 5000$ when $t = 0$, find P when

a $t = 5$,

b $t = 25$.

3 If $\frac{dQ}{dt} = -0.01Q$, $Q > 0$, and $Q = 100\,000$ when $t = 0$, find Q when

a $t = 20$,

b $t = 50$.

4 A particular radioactive isotope decays continuously at a rate of 8% per year. Five kilograms of this isotope are produced in a particular industrial process. How much remains undecayed after 25 years?

5 A particular radioactive isotope decays continuously at a rate of 2% per year. Twenty kilograms of this isotope are produced in a particular industrial process. How much remains undecayed after 50 years?

6 Find the half-life of a radioactive element that decays according to the rule:

$$\frac{dA}{dt} = -0.0004A, \text{ where } A \text{ is the amount present after } t \text{ years.}$$

(The half-life of a radioactive element is the time taken for the amount present to halve.)

7 Cesium-137, a radioactive form of the metal Cesium, decays such that the mass $M(t)$ kg present after t years satisfies the rule $\frac{dM}{dt} = -kM$.

The half-life of a radioactive element is the time taken for the amount present to halve, and for Cesium-137 this is 30 years.

If 1 kg of Cesium-137 is produced in a certain industrial process how much of this remains radioactive after

a 30 years?

b 60 years?

c 40 years?

8 The radioactive Uranium isotope U-234 decays such that the mass $M(t)$ kg present after t years satisfies the rule $\frac{dM}{dt} = -kM$.

The half-life of a radioactive element is the time taken for the amount present to halve, and for U-234 this is 250 000 years.

What percentage of an original amount of U-234 remains after 5000 years?

The logistic model for growth

Let us consider further the differential equation

$$\frac{dP}{dt} = kP, \text{ with } k > 0,$$

and its solution $P = P_0 e^{kt}$, shown graphed on the right.

Whilst this model might apply for some growth situations, in many cases the exponential increase might not continue indefinitely in this way. The increase in a population, be it human, animal, bacterial, etc., may well be influenced by other factors such as food supply, available space, predators, etc. For some situations it may be more likely that the initial growth rate will, after a while, decrease and the population may start to head towards some steady, maintainable level. For such situations the unbroken line in the second graph might be a better model to use.

Such a model can be described algebraically by a differential equation of the form:

$$\frac{dP}{dt} = k_1 P - k_2 P^2$$

Or, using y and t for our variables and a and b as the constants:

$$\frac{dy}{dt} = ay - by^2, \text{ with } a > 0 \text{ and } b > 0.$$

This is called **the logistic equation**. It has the general solution

$$y = \frac{a}{b + ce^{-at}} \quad \text{where } c \text{ is some constant.}$$

Note that with $y = \frac{a}{b + ce^{-at}}$ as $t \rightarrow \infty$ then $y \rightarrow \frac{a}{b}$.

Hence the *levelling-out* or *limiting* population, also called the *carrying capacity*, is $\frac{a}{b}$.

For this reason the logistic equation general solution

is sometimes written as
$$y = \frac{K}{1 + Ce^{-at}}$$

because, in this form, K is the levelling-out population.

To give the required growth model we require $C > 0$ because then, as $t \rightarrow \infty$, the population will approach the limiting value K 'from below'.

The reader should view the graphs of $y = 500e^{0.2x}$ (uninhibited growth)
and $y = \frac{5000}{1 + 9e^{-0.2x}}$ (logistic model)

(use $0 \leq x \leq 30$ and $0 \leq y \leq 6000$) and see if a 'levelling off' is achieved.

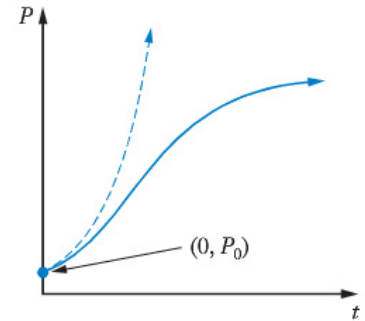
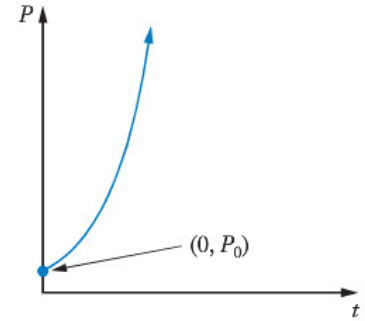

Note

The reader should confirm that differentiating this general solution with respect to t does indeed give a differential equation of the required form.

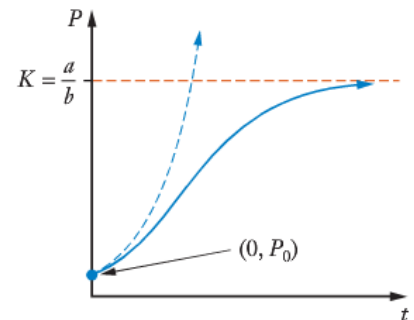

Alternatively we could write:

$$\text{From [1]:} \quad \ln|N| - \ln|2000 - N| = 0.25t + c.$$

$$\text{Hence} \quad \ln \left| \frac{N}{2000 - N} \right| = 0.25t + c$$

$$\begin{aligned} \text{and so} \quad \frac{N}{2000 - N} &= \pm A e^{0.25t} \quad (\text{with } A = e^c). \\ &= C e^{0.25t} \quad (\text{with } C = \pm A). \end{aligned}$$

Using $N = 40$ when $t = 0$ to determine C , substituting for C and rearranging gives:

$$N = \frac{2000}{1 + 49e^{-0.25t}} \quad \text{as before.}$$

The logistic model has applications in a number of areas, as the previous example and some of the questions of the next exercise show.

Exercise 10C

- 1** When a new technological device is introduced to a country the number of people having the device can grow according to a logistic model. Let us suppose that N , the number of people, in millions, having the device, t months after the monitoring of such numbers began, was such that

$$\frac{dN}{dt} = 0.45N - 0.015N^2.$$

When monitoring commenced 500 000 people had the device (i.e. $N = 0.5$).

Use the fact that a differential equation of the form

$$\frac{dy}{dt} = ay - by^2, \quad \text{with } a > 0 \text{ and } b > 0,$$

has the general solution $y = \frac{a}{b + ce^{-at}}$, where c is some constant, to determine

- a** the value of c for the take up of device situation,
 - b** the number of people with the device 10 months after the monitoring began.
- 2** A researcher investigates how quickly a rumour spreads amongst an island community of 150 000 people. When the research commences it is thought that 300 of the 150 000 know the rumour. One day later 920 know it.

Applying a logistic model to this situation, if y is the number of people from the community of 150 000 who know the rumour, t days after research commenced:

$$y = \frac{K}{1 + Ce^{-at}}, \quad \text{with } K = 150\,000.$$

How many people does the model predict will know the rumour 5 days after the research began (to the nearest 100 people)?

Can we get some idea of what the relationship between x and y will look like from the differential equation directly, without integrating?

Whilst there are a number of methods for solving differential equations, other than separating the variables, not all differential equations are solvable algebraically.

In such cases we might be able to use the differential equation to learn what the graph of the relationship looks like. To help us understand this approach we will initially consider it for differential equations that we *could* algebraically integrate.

Consider the differential equation $\frac{dy}{dx} = 2$.

By integrating we know this has the general solution $y = 2x + c$.

Could we make this general solution apparent without integrating?

One way is to draw the **slope field** of the differential equation, also called the **direction field** or **gradient field**.

Slope fields

A **slope field** of a differential equation shows the derivative at a given point as a line segment drawn at that point, with the gradient of the line segment equal to the derivative at that point.

For the differential equation $\frac{dy}{dx} = 2$ the gradient is always equal to 2 so we would expect the slope field to show line segments all having a gradient of 2.

This is indeed the case in the diagrams shown, which show the slope field for this differential equation, as a graph below and on a calculator display on the right.

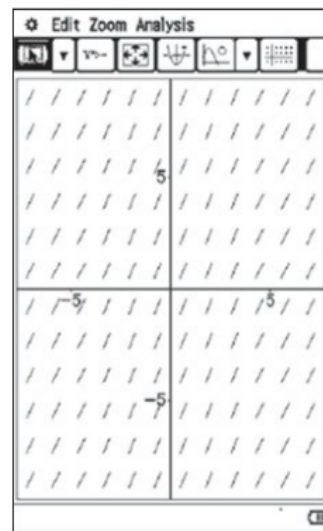
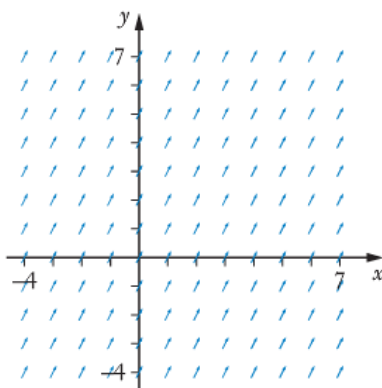

Can you see how the lines of the slope field suggest the family of curves that form the general solution, i.e. $y = 2x + c$?



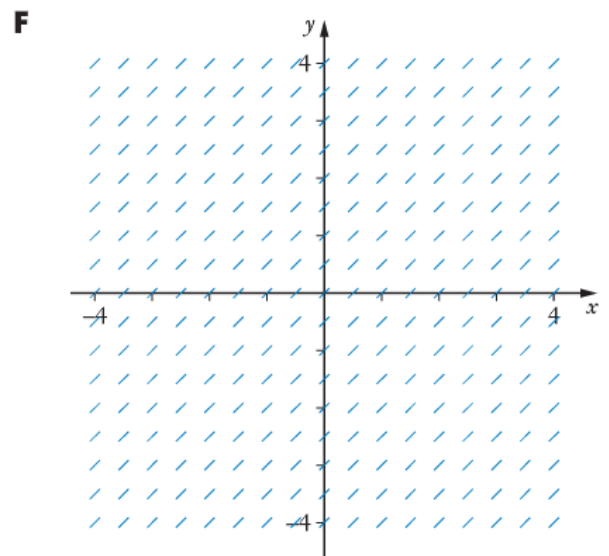
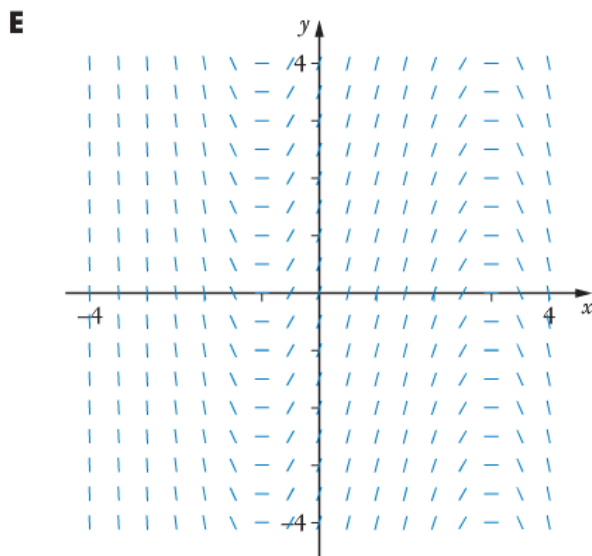
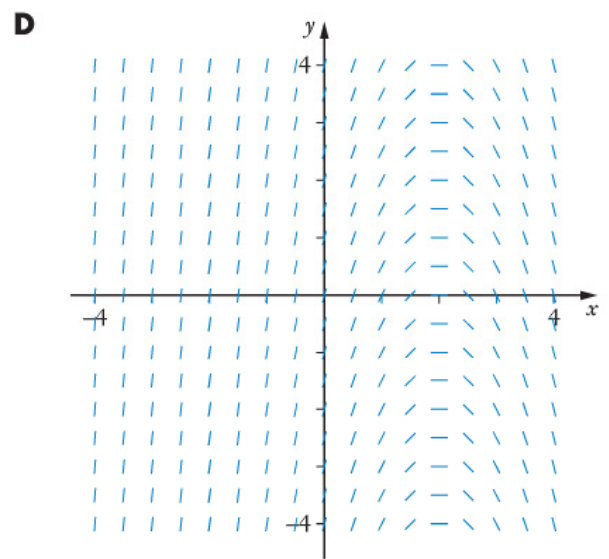
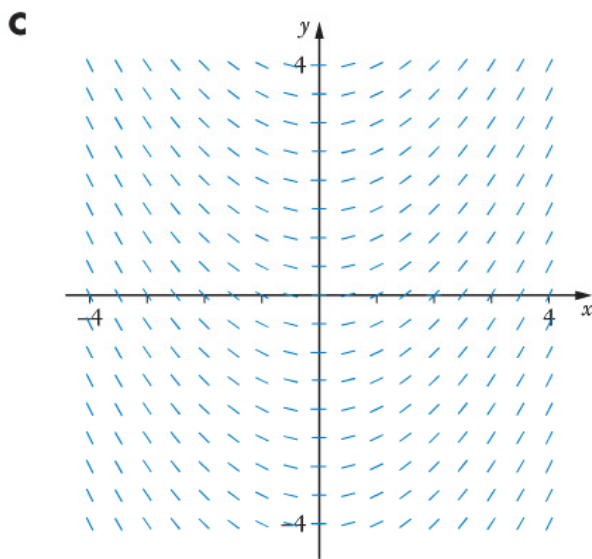
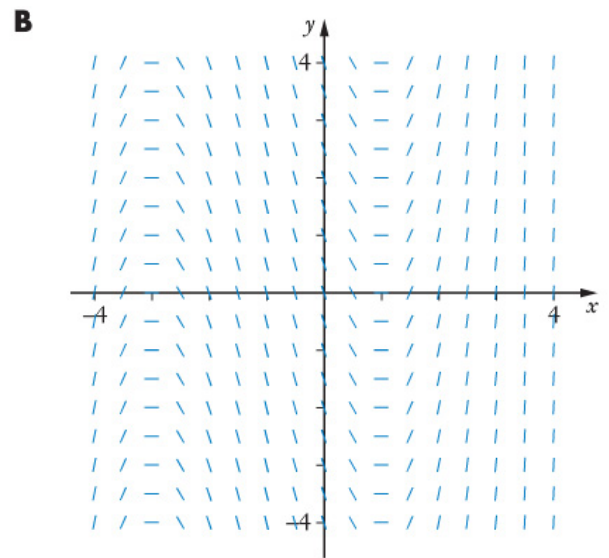
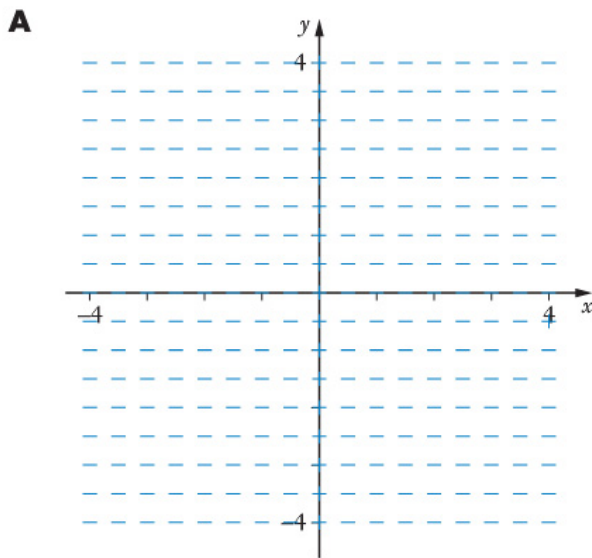

Euler's method

We will consider here a numerical method for finding an approximate graphical solution to a differential equation, given some initial conditions. A numerical method would be of most use when solving differential equations that are not easily solved algebraically, and whose slope fields may not be easy to draw. However we will apply the method to a differential equation we could solve algebraically, so that we can see how accurate our solution obtained numerically is.

First recall the **small changes formula**, or **incremental formula**, first encountered in *Mathematics Methods* Unit Three, and revised earlier in this book.

δy , the small change in y , caused by δx , the small change in x , can be approximately determined using

$$\delta y \approx \frac{dy}{dx} \delta x.$$

Consider the differential equation $\frac{dy}{dx} = 2x - 4$ for $x \geq 0$, and suppose that when $x = 0, y = 1$.

We know that the solution is $y = x^2 - 4x + 1$ which is shown graphed on the right, for $x \geq 0$.

Let us now try to obtain this graph by applying a numerical method to the differential equation.

Starting at our known point $(0, 1)$ we will increase the x -coordinate by δx . Then, using the incremental formula to determine δy , the approximate change in y , we will have a new point $(x + \delta x, y + \delta y)$. We then repeat the process with this new point to give the next point, and so on. Plotting the points will give us an approximate graphical solution to the differential equation.

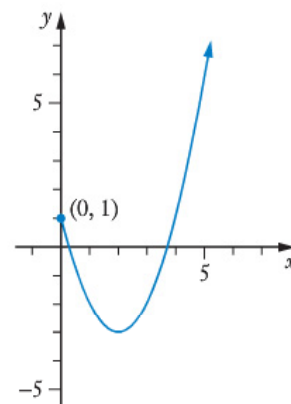

Let us choose $\delta x = 1$, and so
$$\begin{aligned} \delta y &\approx \frac{dy}{dx}(1) \\ &= (2x - 4)(1) \end{aligned}$$

Now create a table starting at $(0, 1)$ and increasing by $\delta x = 1$ each step.

	x	y	δx	$\delta y = (2x - 4)(1)$	(Next point)	
					$x + \delta x$	$y + \delta y$
From 1st point	0	1	1	$2(0) - 4 = -4$	1	-3
From 2nd point	1	-3	1	$2(1) - 4 = -2$	2	-5
From 3rd point	2	-5	1	$2(2) - 4 = 0$	3	-5
From 4th point	3	-5	1	2	4	-3
From 5th point	4	-3	1	4	5	1
From 6th point	5	1	1	6	6	7

Miscellaneous exercise ten

This miscellaneous exercise may include questions involving the work of this chapter, the work of any previous chapters in this unit, and the ideas mentioned in the Preliminary work section at the beginning of the unit.

- 1 The three slope fields shown below are for the differential equations

$$\frac{dy}{dx} = y - x$$

$$\frac{dy}{dx} = \frac{x}{y}$$

$$\frac{dy}{dx} = y - 1$$

By considering locations where $\frac{dy}{dx} = 0$ match each equation to a slope field.

Slope field A

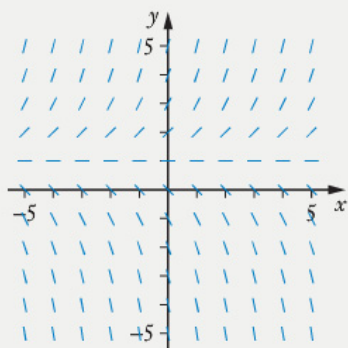

Slope field B

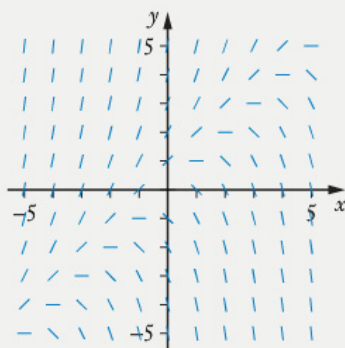

Slope field C

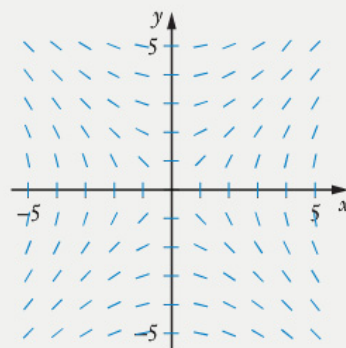

- 2 In enzymology (the study of enzymes), an important differential equation is the Michaelis-Menten equation, which takes the form:

$$\frac{ds}{dt} = -\frac{Vs}{K + s}, \text{ where } s \text{ and } t \text{ are variables } (s > 0) \text{ and } V \text{ and } K \text{ are constants.}$$

Use the method of separation of variables to obtain the general solution

$$s + K \ln s = -Vt + c, \text{ where } c \text{ is some constant.}$$

- 3 If $\frac{dy}{dx} = e^{x^2}$ use the incremental formula $\frac{\delta y}{\delta x} \approx \frac{dy}{dx}$ to find the approximate change in y when x changes from 2.001 to 2.002.

Compare your answer with a calculator evaluation of $\int_{2.001}^{2.002} e^{x^2} dx$.

- 4 Find an expression for $\frac{dy}{dx}$ for each of the following:

a $y = 2 \sin x$

b $y = \sin^2 x$

c $y = \sin(\sin x)$

d $y = \frac{2x + 3}{5 - 3x}$

e $y = (2x + 3)^3$

f $2xy + y^3 - 15 = 3 \sin x$

g $x^2 + 3y^2 = y \ln x$

h $5x + 3 \ln(2y + 1) = 3xy$

12 Show that if $x = a \sin u$ then

$$\int \frac{1}{\sqrt{a^2 - x^2}} dx = u + c,$$

where c is some constant.

13 Suppose that the function $A(t)$ gives the total worldwide reserve of a particular natural resource at time t years. If this resource is being used at an instantaneous rate of R tonnes/year, A will decrease and so $R = -\frac{dA}{dt}$.

If R itself is continuously increasing at 8% per year then $\frac{dR}{dt} = 0.08R$,

i.e. $R = R_0 e^{0.08t}$ where R_0 is the rate of use, in tonnes/year, when $t = 0$.

Thus the rate of change of world reserves of this commodity is given by:

$$\frac{dA}{dt} = -R_0 e^{0.08t}$$

If our current instantaneous rate of use is 5 000 000 tonnes per year, find

- a** the amount we will use during the next ten years,
- b** in how many years the resource will be exhausted if current world reserves are 200 000 000 tonnes and no new reserves are discovered.

14 One of the worked examples in an earlier chapter determined that the antiderivative of $\cos^4 x$ is

$$\frac{3}{8}x + \frac{\sin 2x}{4} + \frac{\sin 4x}{32} + c.$$

However, as the display above right suggests, the answer could be

$$\frac{\sin x \cos^3 x}{4} + \frac{3 \sin x \cos x}{8} + \frac{3x}{8}.$$

Show that, with the exception of the fact that the calculator display does not show the constant, these two expressions are the same.

$$\int (\cos(x))^4 dx$$

$$\frac{\sin(x) \cdot (\cos(x))^3}{4} + \frac{3 \cdot \sin(x) \cdot \cos(x)}{8} + \frac{3 \cdot x}{8}$$

11.

Simple harmonic motion

- Revision of rectilinear motion
- A particular type of rectilinear motion:
Simple harmonic motion
- Solving the differential equation $\ddot{x} = -k^2x$
- Miscellaneous exercise eleven

EXAMPLE 2

A particle travels along a straight line with its velocity at time t seconds given by v m/s where $v = 6t^2 - 3$.

The initial displacement of the particle from a point O on the line is 5 metres.

Find the displacement of the particle from O when $t = 5$.

Solution

$$\begin{aligned}x &= \int v \, dt = \int (6t^2 - 3) \, dt \\ &= 2t^3 - 3t + c\end{aligned}$$

We know that initially, i.e. when $t = 0$, $x = 5$.

$$\therefore 5 = 2(0)^3 - 3(0) + c \quad \text{i.e. } c = 5.$$

$$\text{Thus } x = 2t^3 - 3t + 5 \quad \therefore \text{When } t = 5, x = 240.$$

When $t = 5$ the displacement from O is 240 metres.

The previous two examples involved functions given in terms of t , the time. This may not always be the case. We could, for example, be given the velocity, v , in terms of the displacement, x , (as we saw in chapter 8). The next examples involve such situations, but first note the following useful rearrangement.

$$\begin{aligned}\text{Acceleration} &= \frac{dv}{dt} \\ &= \frac{dv}{dx} \frac{dx}{dt}. \quad \text{But } \frac{dx}{dt} = v.\end{aligned}$$

$$\text{Hence, acceleration} = v \frac{dv}{dx}. \quad \text{This could also be written as } \frac{d}{dx} \left(\frac{1}{2} v^2 \right).$$

In the examples that follow assume that x m, v m/s and a m/s² represent displacement, velocity and acceleration respectively.

EXAMPLE 3

If $v = 3x$ find the acceleration when $x = 2$.

Solution

$$\begin{aligned}a &= \frac{dv}{dt} = \frac{dv}{dx} \frac{dx}{dt} \\ &= v \frac{dv}{dx} \\ &= (3x)(3) \\ &= 9x\end{aligned}$$

Thus when $x = 2$, $a = 18$. When $x = 2$ the acceleration is 18 m/s².

Repeat the previous example but instead write $\frac{dx}{dt} = 3x$, integrate using separation of variables to find an expression for x and then differentiate twice to find the acceleration.



2 $a = \frac{6t(t+1)^2}{5}$. Find the velocity when $t = 0$ given that when $t = 1$, $v = 2$ m/s.

3 If $x = 5 + 2 \cos t$ find **a** the velocity when $t = \frac{\pi}{6}$, **b** the acceleration when $t = \frac{\pi}{2}$.

4 If $v = 4 \sin 2t$ find **a** the acceleration when $t = \frac{\pi}{6}$,
b the displacement when $t = \frac{\pi}{2}$ given that for $t = 0$, $x = 3$.

5 If $a = 4 \sin t \cos t$ and when $t = 0$, the displacement is 5 m and the velocity is 3 m/s, find
a the velocity when $t = \frac{\pi}{3}$, **b** the displacement when $t = \frac{\pi}{3}$.

6 If $v = 5 + x^2$ find the acceleration when $x = 1$.

7 If $a = 3x^2 + 1$ and when $x = 0$, $v = 2$, find the velocity, $v > 0$, when $x = 3$.

8 If $a = v^2$, $v > 0$, and when $t = 2$, $x = 0$ and $v = 0.1$, find
a v when $t = 10$, **b** v when $x = 2$.

9 The displacement of a body from an origin O, at time t seconds, is x metres, where

$$x = \frac{t+1}{2t+3}, \quad t \geq 0.$$

Find **a** expressions for the velocity and acceleration of the body in terms of t ,
b the displacement, velocity and acceleration of the body when $t = 1$.

10 An object projected vertically upwards from a point above ground level is h metres above ground level t seconds later, where $h = 42 + 29t - 5t^2$ ($t \geq 0$). For what value of t , and at what speed, does the object hit the ground?

11 A particle is initially at an origin O. It is projected away from O and moves in a straight line such that its displacement from O, t seconds later, is x metres, where

$$x = t(16 - t).$$

Find **a** the speed of the particle when $t = 20$,
b the value of t when the particle comes to rest and the distance from the origin at that time,
c the distance the particle travels from $t = 1$ to $t = 5$,
d the distance the particle travels from $t = 5$ to $t = 10$.

12 A body is initially at an origin, O. At that instant the velocity of the body is 35 m/s. The acceleration, t seconds later, is $6(t - 4)$ m/s². Find the velocity of the body when it is **next** at O.

13 A particle passes through an origin O at time $t = 0$ and travels along a straight line such that its velocity t seconds later, is v m/s where

$$v = 2 \sin 2t$$

Determine **a** the maximum velocity of the particle during the motion,
b an expression for the acceleration of the particle at time t ,
c the maximum acceleration of the particle during the motion,
d an expression for the displacement of the particle at time t ,
e the maximum displacement of the particle during the motion.

Solving the differential equation $\ddot{x} = -k^2x$

As we have already seen in the previous chapter:

- Any equation that involves one or more derivatives, e.g. $\frac{dy}{dx}$, $\frac{dp}{dt}$, $\frac{d^2x}{dt^2}$, etc, is called a **differential equation**.
- To *solve* a differential equation we must find a relationship between the variables involved, that satisfies the differential equation, but that does not contain any derivatives.

Thus, to solve $\ddot{x} = -k^2x$ we need to find a relationship between x and t , not involving derivatives.

From $\ddot{x} = -k^2x$

it follows that $\frac{dv}{dt} = -k^2x$.

Hence, by the chain rule $\frac{dv}{dx} \frac{dx}{dt} = -k^2x$.

But $\frac{dx}{dt} = v$ and so $v \frac{dv}{dx} = -k^2x$.

Separating the variables $\int v dv = -\int k^2x dx$
 $\frac{v^2}{2} = -\frac{k^2x^2}{2} + c$

But if 'a' is the amplitude then when $x = a$, $v = 0$.

Hence $0 = -\frac{k^2a^2}{2} + c$

i.e. $c = \frac{k^2a^2}{2}$

Thus $v^2 = k^2(a^2 - x^2)$

where a is the amplitude of the motion.

Taking the positive square root $v = k\sqrt{a^2 - x^2}$

i.e. $\frac{dx}{dt} = k\sqrt{a^2 - x^2}$

Separating the variables $\int \frac{dx}{\sqrt{a^2 - x^2}} = \int k dt$

Using the substitution $x = a \sin u$, from which $\frac{dx}{du} = a \cos u$,

$$\int 1 du = \int k dt$$

i.e. $u = kt + \alpha$ (α is the integration const.)

$\therefore x = a \sin(kt + \alpha)$



From earlier work involving trigonometric functions we know that many trigonometrical expressions can be written in other ways.

For example we can write $\sin \theta$ as $\cos\left(\theta - \frac{\pi}{2}\right)$,

we can write $\sin(\theta + \alpha)$ as $\sin \theta \cos \alpha + \cos \theta \sin \alpha$ etc.

Hence it may come as no surprise that $x = a \sin(kt + \alpha)$ is not the only way of expressing the solution to $\frac{d^2x}{dt^2} = -k^2x$.

Show that

$$x = a \cos(kt + \beta)$$

and

$$x = C \cos kt + D \sin kt$$

each satisfy the equation

$$\frac{d^2x}{dt^2} = -k^2x.$$

Note: Earlier, when solving we obtained the equation

$$\begin{aligned} \ddot{x} &= -k^2x \\ v^2 &= k^2(a^2 - x^2). \end{aligned}$$

Then 'taking the positive square root', i.e.

$$v = k\sqrt{a^2 - x^2}$$

we wrote this as

$$\frac{dx}{dt} = k\sqrt{a^2 - x^2}$$

separated the variables and integrated using the substitution

$$x = a \sin u.$$

Repeat this process but instead use the negative square root, separate the variables and integrate using the substitution

$$x = a \cos u.$$

EXAMPLE 6

Determine the period of the simple harmonic motion defined by the equation

$$\ddot{x} = -16x.$$

Solution

Comparing $\ddot{x} = -16x$ with $\ddot{x} = -k^2x$ gives $k = 4$.

Using $T = \frac{2\pi}{k}$ $T = \frac{2\pi}{4}$
 $= \frac{\pi}{2}$.

The period of the simple harmonic motion is $\frac{\pi}{2}$ seconds.



EXAMPLE 8

A body moves with SHM about some mean position O. The amplitude of the motion is 0.5 metres, the period is 2π seconds and when $t = 0$ the body is at O.

- Find **a** the two possible expressions of the form $x = a \sin(kt)$ for the displacement of the body from O at time t ,
b the speed of the body when $t = \frac{\pi}{3}$.

Solution

- a** The amplitude is 0.5 m and when $t = 0$ the body is at O.

Therefore $x = \pm 0.5 \sin kt$

(The \pm is necessary because at $t = 0$ motion may be to the right or to the left. We are not told whether the displacement is positive or negative for small positive t .)

The period is 2π , therefore $\frac{2\pi}{k} = \pi$ giving $k = 1$.

The displacement of the body from O at time t is x m where $x = \pm 0.5 \sin t$.

- b** If $x = \pm 0.5 \sin t$ then $\dot{x} = \pm 0.5 \cos t$

When $t = \frac{\pi}{3}$ $\dot{x} = \pm 0.25$

When $t = \frac{\pi}{3}$ the body has speed 0.25 m/s.

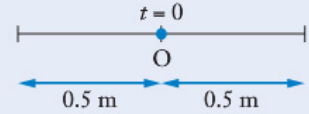

EXAMPLE 9

A body moves with SHM about some mean position O. The amplitude of the motion is 2 metres, the period is $\frac{\pi}{5}$ seconds and when $t = 0$ the displacement of the body from O is 1 metre and the velocity is positive.

- Find **a** an expression for the displacement of the body from O at time t , giving your answer in the form $x = a \sin(kt + \alpha)$ for $0 \leq \alpha \leq \pi$,
b the greatest speed attained by the body,
c the greatest acceleration of the body.

Solution

- a** The amplitude is 2 m therefore

$$x = 2 \sin(kt + \alpha).$$

The period is $\frac{\pi}{5}$, therefore

$$\frac{2\pi}{k} = \frac{\pi}{5} \quad \text{i.e. } k = 10$$

Thus

$$x = 2 \sin(10t + \alpha)$$

When $t = 0$, $x = 1$, therefore

$$1 = 2 \sin \alpha$$

giving

$$\alpha = \frac{\pi}{6} \text{ or } \frac{5\pi}{6}$$

If $x = 2 \sin\left(10t + \frac{\pi}{6}\right)$

$$v = 20 \cos\left(10t + \frac{\pi}{6}\right)$$

and if $x = 2 \sin\left(10t + \frac{5\pi}{6}\right)$

$$v = 20 \cos\left(10t + \frac{5\pi}{6}\right)$$

Only the first of these velocities is positive when $t = 0$.

The displacement from O at time t is x m where $x = 2 \sin\left(10t + \frac{\pi}{6}\right)$

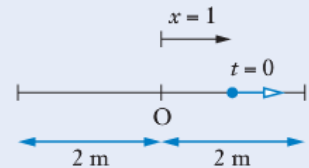

- 7** A body moves such that its displacement from an origin O at time t seconds is x m, where $x = 4 \sin \frac{\pi t}{10}$.
- Prove that the motion is simple harmonic.
 - Determine the period and amplitude of the motion.
 - How far does the body move in the first two seconds (to the nearest cm)?
- 8** A body moves such that its displacement from an origin O at time t seconds is x m, where $x = 2 \sin \frac{\pi t}{3}$.
- Prove that the motion is simple harmonic.
 - Determine the period and amplitude of the motion.
 - Exactly how far does the body move in the first two seconds?
- 9** A body moves such that its displacement from an origin O at time t seconds is x m, where $x = 3 \sin \left(2t + \frac{\pi}{6} \right)$.
- Prove that the motion is simple harmonic.
 - Determine the period and amplitude of the motion.
 - How far does the body move in the first second (to the nearest cm)?
- 10** A body moves with simple harmonic motion about some mean position O. The amplitude of the motion is 4 metres, the period is 2 seconds and initially (i.e. when $t = 0$) the displacement of the body from O is 2 metres and the velocity is negative.
- Find
- an expression for the displacement of the body from O at time t seconds giving your answer in the form $x = a \sin(kt + \alpha)$ for $0 \leq \alpha \leq \pi$.
 - the speed of the body when $t = \frac{1}{6}$.
- 11** A body moves with simple harmonic motion about some mean position O. The amplitude of the motion is 2 metres, the period $\frac{2\pi}{5}$ seconds and when $t = 0$ (i.e. initially) the displacement of the body from O is $\sqrt{2}$ m and the velocity is positive.
- Find
- an expression for the displacement of the body from O at time t sec giving your answer in the form $x = a \sin(kt + \alpha)$ for $0 \leq \alpha \leq \pi$,
 - the greatest speed attained by the body,
 - the greatest acceleration of the body.
- 12** A body moves with SHM with equation $\ddot{x} = -4x$, where x m is the displacement of the body from a fixed point O at time t seconds. Initially, i.e. when $t = 0$, the body is at O and has a positive velocity. If the amplitude of the motion is 0.6 m determine
- the displacement of the body from O when $t = \frac{\pi}{6}$,
 - the displacement of the body from O when $t = \frac{\pi}{3}$,
 - the value of t ($t \geq 0$) when the body is a distance of 0.3 m from O for
 - the first time,
 - the second time,
 - the third time.

- 18** An object moves such that its displacement, x metres, from some fixed point O, at time t seconds, is given by $x = -4\sqrt{3} \sin 2t - 4 \cos 2t$.
- How far is the object from O when $t = 0$?
 - Prove that for this motion $\ddot{x} = -k^2x$ and determine the value of k .
 - How far does the object move in the first 1.5 seconds (to the nearest cm)?

- 19** A particle moves such that its displacement, x m, from some fixed point O at time t seconds is given by

$$x = 3 + 4 \sin \pi t$$

- Show that this satisfies $\ddot{p} = -k^2p$ where $p = x - 3$ and k is a constant.
- By completing part **a** you have shown that the motion is simple harmonic. What is the period and amplitude of the motion?
- If point B is the mean position of the SHM, how far is B from O?
- What is the greatest distance that the particle is from O during the SHM?

- 20** A particle moves such that its displacement, x m, from some fixed point O at time t seconds is given by

$$x = 5 - 3 \cos 2t$$

- Show that this satisfies $\ddot{s} = -k^2s$ where $s = x - 5$ and k is a constant.
- By completing part **a** you have shown that the motion is simple harmonic. What is the period and amplitude of the motion?
- If point P is the mean position of the SHM, how far is P from O?
- What is the least distance that the particle is from O during the SHM?

- 21** An object moves along the x -axis with its velocity, v m/s, at time t seconds given by:

$$v = \frac{1}{4} \cos t.$$

- Determine
- the distance travelled by the object from $t = 0$ to $t = 1$, giving your answer to the nearest centimetre.
 - the distance travelled by the object from $t = 0$ to $t = 2$, giving your answer to the nearest centimetre.

- 22** A particle moves with SHM about some mean position O with its displacement from O at time t seconds being x m and its velocity at that instant being v m/s.

If $x = 20$ when $v = 30$ and $x = 24$ when $v = 14$ find the period and amplitude of the motion.

- 23** A particle moves with SHM about some mean position O with its displacement from O at time t seconds being x m and its velocity at that instant being v m/s.

If $x = 0.6$ when $v = 0.75$ and $x = 0.39$ when $v = 1.56$ find the period and amplitude of the motion.

7 Find the volume of the solid formed by rotating the area enclosed between the curve $y = 4\sqrt{x}$ and the x -axis from $x = 3$ to $x = 5$ through one revolution about the x -axis.

8 Find the area bounded by $y = \cos^3 x$ and the x -axis from $x = 0$ to $x = \frac{\pi}{2}$.

9 a Find, exactly, the area of the region lying in the first quadrant and enclosed by:

$$\text{the curve } y = 2(x^2 + 1),$$

the x -axis, the y -axis and the line $x = 2$.

b Find, exactly, the volume of the solid of revolution formed by rotating the region described in part **a** through 360° about the x -axis.

c Find, exactly, the volume of the solid of revolution formed by rotating the region described in part **a** through 360° about the y -axis.

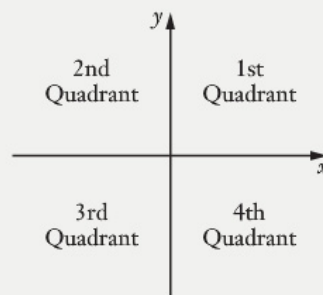

10 A particle travels along a straight line with its acceleration at time t seconds equal to $(6t + 4) \text{ m/s}^2$. The particle has an initial positive velocity and travels 32 m in the third second. Find the velocity of the body when $t = 1$.

11 In each of the following x m is the displacement of an object from some fixed origin O at time t seconds. Prove that each object is executing simple harmonic motion, and in each case find the period of the motion, the value of x when $t = 0$ and the distance from the mean position to the point O.

a $x = 2 \sin 4t,$

b $x = 5 \cos 3t,$

c $x = 2 \cos 2t + 4 \sin 2t,$

d $x = 1 + 3 \sin 5t.$

12 Particles A and B are each executing simple harmonic motion.

The displacement, x metres, from the respective mean positions, at time t seconds is given by

$$x = c \sin k_1 t \quad \text{for particle A}$$

and $x = d \sin k_2 t$ for particle B, (c, k_1, d and k_2 all positive constants).

A graph for each motion is shown below.

Particle A

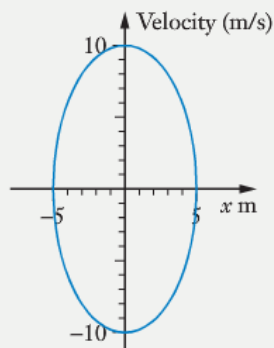

Particle B

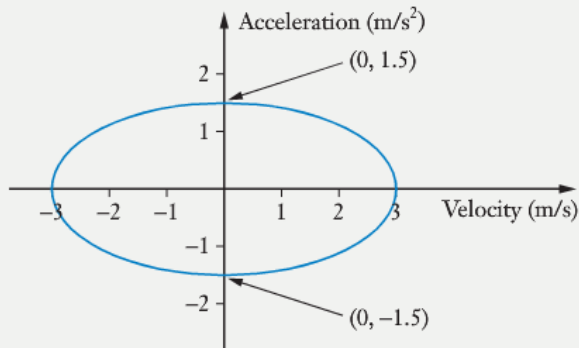

Find c, d, k_1, k_2 and the time period for each particle.



12.

Sample means

- Sampling
- Distribution of sample means
- Increasing the number of samples
- Increasing the sample size
- The central limit theorem
- Sample size
- Samples with means that are unusually high or unusually low
- Inferring population parameters from sample statistics
- So do most 95% confidence intervals really contain the population mean? Let's check
- Choosing the sample size
- Miscellaneous exercise twelve

Note

For the purposes of this chapter it is anticipated that, from your study of *Mathematics Methods*, you are now familiar with the idea of probability distributions and the **binomial**, **uniform** and **normal distributions** in particular.

Sampling

In some cases it is simply too expensive, too inconvenient or just unwise to obtain information about a particular set by testing all of the elements that make up the set.

For example, if a doctor wishes to check on the progress of a human pregnancy they may carry out an amniocentesis on the mother. This process involves the doctor in taking, and having analysed, a sample of the amniotic fluid (the fluid surrounding the baby) from the mother. In this case, a sample of the amniotic fluid should be taken, not all of it!



Shutterstock.com/Topalov



Shutterstock.com/Shulevskyy Velodymyr

If a commercial cherry grower wants to test how nice his cherries are he might taste a few – he would not eat them all!

Judgements can then be made about the **population** as a whole based on what we find from the sample. In this chapter we will consider making judgements about what the **mean** of a population might be (be it mean height, mean weight, mean sugar content or whatever) from the mean of that quantity found in a sample that we take.

If you are also studying *Mathematics Methods* Unit Four at this time it is likely that you are considering, or are soon to consider, the idea of predicting a *population proportion* based on a sample proportion. This prediction of a population characteristic follows very similar ideas whether we are predicting a population proportion, as in *Mathematics Methods*, or predicting a population mean, as in this unit of *Mathematics Specialist*.

Numerical characteristics about an entire population, for example, the proportion of Australians who are left-handed, or the mean length of the crocodiles in an area, are called **population parameters**. Predicting a value for a population parameter, based on the equivalent **sample statistic**, is often why we collect data from a sample.

The bigger our sample the more confident we can be that information from the sample reflects the same information about the population.



We might consider taking a number of samples to assess whether our one sample is typical of others and to 'get a feel for' the variability that may exist between samples.

If we wanted information about Australian school children we might use a sample involving, say, 500 Australian school children, and use the information from this sample to suggest information about the entire population of Australian school children.

If our sample of 500 Australian school children is a **random sample** then it is constructed in such a way that each Australian school child has an equal chance of being in the sample of 500.

Distribution of sample means

Suppose we want to investigate the mean value obtained when a normal six-sided die is rolled many times.

We know from the symmetry of the situation that each of the numbers

1, 2, 3, 4, 5, 6

has an equal chance of occurring on each roll.

The mean or expected value, i.e. the long term average, of this uniform distribution is 3.5 (and the standard

deviation is $\sqrt{\frac{35}{12}}$ or, to two decimal places, 1.71).

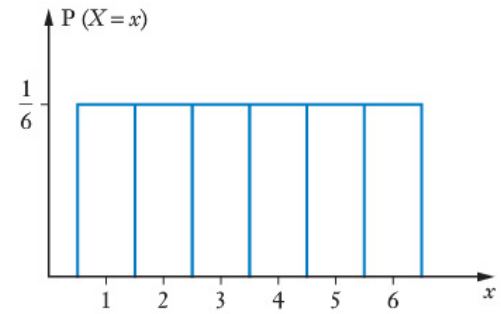

Suppose we were to investigate this situation by sampling just 4 rolls of a normal die.

Question: Would the mean of the 4 rolls necessarily be 3.5?

Answer: Whilst the mean could be 3.5 it does not have to be 3.5.
i.e. the mean is *not necessarily* equal to 3.5.

One such sample of 4 rolls of a normal die gave

4, 6, 3, 2. Mean = 3.75

Suppose we again roll the die 4 times.

Question: Would the mean of the 4 rolls again be 3.75?

Answer: Not necessarily.

The next sample of 4 rolls of a normal die gave

6, 1, 2, 1. Mean = 2.5

If we were to continue rolling the die 4 times and were to calculate the mean score each time, we would expect some variation to occur in these mean scores, i.e., we would expect a **distribution of sample means**, the first two of which were 3.75 and 2.5.

Suppose we continue the process to obtain 30 samples of 4 rolls, i.e. 30 samples of 'sample size' 4:

4	6	3	2	mean	3.75	6	6	4	1	mean	4.25
6	1	2	1		2.5	3	1	1	4		2.25
1	5	4	5		3.75	4	3	5	1		3.25
2	5	1	2		2.5	6	1	1	4		3
6	5	3	6		5	5	4	3	4		4
4	1	3	2		2.5	1	5	3	5		3.5
6	2	6	6		5	1	1	3	3		2
6	6	2	4		4.5	3	5	6	6		5
2	2	1	4		2.25	6	6	2	1		3.75
4	4	1	2		2.75	2	6	3	4		3.75
3	5	5	4		4.25	6	1	4	2		3.25
1	2	1	3		1.75	5	5	4	3		4.25
2	6	5	4		4.25	1	6	1	5		3.25
1	2	3	4		2.5	5	4	4	2		3.75
2	2	2	2		2	5	4	1	2		3

For these 30 samples of 4 rolls, our **distribution of sample means** is as follows:

Mean	1.75	2	2.25	2.5	2.75	3	3.25	3.5	3.75	4	4.25	4.5	4.75	5
Frequency	1	2	2	4	1	2	3	1	5	1	4	1	0	3

Mean of sample means (2 decimal places): 3.38

Standard deviation of sample means (2 decimal places): $\sigma_n = 0.93$, $\sigma_{n-1} = 0.95$.

Grouping the data:

Mean (\bar{x})	$1 \leq \bar{x} < 2$	$2 \leq \bar{x} < 3$	$3 \leq \bar{x} < 4$	$4 \leq \bar{x} < 5$	$5 \leq \bar{x} < 6$
Frequency	1	9	11	6	3

- Note:
- Whilst dice-rolling involves a uniform distribution of outcomes the distribution of sample means does not display this same uniformity. Most of our means are close to the population mean of 3.5.
 - The standard deviation of a sampling distribution of mean values is sometimes referred to as the **standard error** of the mean.

Increasing the number of samples

Suppose we increase the number of samples of 4 rolls of the die from 30 to, say 100, or even 200, to get more sample means.

How do you think the mean and the standard deviation of the sample means would compare to the 3.38 (mean) and 0.93 (standard deviation) values obtained above for 30 samples?



The following statistics were obtained for 100 and 200 samples of 4 rolls:

For 100 samples of four rolls:	Mean of sample means	3.523
	Standard deviation of sample means	$\sigma_{n-1} = 0.847$, $\sigma_n = 0.843$
For 200 samples of four rolls:	Mean of sample means	3.518
	Standard deviation of sample means	$\sigma_{n-1} = 0.836$, $\sigma_n = 0.834$

Do these figures support what you thought would be the case?

Increasing the sample size

Suppose we increase the sample size from samples involving 4 rolls of the die to samples involving 10 rolls of the die, or perhaps 35 rolls of the die or even 100 rolls of the die.

How would you expect this increased sample size to affect the mean and the standard deviation of the sample means?

The sample means for 30 samples each involving 10 rolls (i.e. sample size 10) were:

4.1	4.1	3	3.7	2.9	4	3.8	3.9	2.6	3.8
3.9	4.2	3.8	3.6	3.8	2.9	2.9	3.5	3.5	4.4
3.9	3.4	3.7	3.8	3.2	4.1	3.2	3.4	3.2	2.7

Mean of sample means:	3.567
Standard deviation of sample means:	$\sigma_{n-1} = 0.477$, $\sigma_n = 0.469$

The sample means for 30 samples each involving 35 rolls (i.e. sample size 35) were:

4.057	3.371	3.114	3.571	3.228	3.429	4.086	3.227	3.457	3.4
3.757	3.2	3.457	3.029	3.171	3.657	2.886	3.286	3.086	3.057
3.771	3.629	3.457	3.6	3.343	3.086	3.743	3.029	3.571	3.629

Mean of sample means:	3.413
Standard deviation of sample means:	$\sigma_{n-1} = 0.303$, $\sigma_n = 0.298$

The sample means for 30 samples each involving 100 rolls (i.e. sample size 100) were:

3.31	3.45	3.66	3.54	3.43	3.71	3.32	3.48	3.36	3.42
3.25	3.52	3.35	3.44	3.53	3.54	3.5	3.53	3.34	3.64
3.57	3.29	3.41	3.89	3.54	3.23	3.47	3.64	3.2	3.68

Mean of sample means:	3.475
Standard deviation of sample means:	$\sigma_{n-1} = 0.157$, $\sigma_n = 0.155$

Notice that the mean of the sample means is quite close to 3.5, the mean of the uniform distribution from which the samples were drawn. Also note that in each case the standard deviation of the sample means is less than 1.71, the standard deviation of the uniform distribution from which the samples were drawn, and that as the sample size increased the standard deviation decreased. The greater the sample size, the less variation there is in the sample means.



The previous paragraph made two important claims, based on the results of the previous pages:

- The sample means are quite close to the mean of the distribution from which the samples were drawn, in this case 3.5.
- The greater the sample size, the less variation there is in the sample means, i.e. as the sample size increased the standard deviation of the sample means decreased.

Let us take this second statement even further and suggest that for a sample size of n the standard deviation of the sample means is close to $\frac{\sigma}{\sqrt{n}}$ where σ is the standard deviation of the population.

In this dice rolling situation $\sigma = 1.7078$, correct to 4 decimal places, so this further suggestion would mean that:

- For a sample size of 4 the standard deviation would be approximately 0.85.
- For a sample size of 10 the standard deviation would be approximately 0.54.
- For a sample size of 35 the standard deviation would be approximately 0.29.
- For a sample size of 100 the standard deviation would be approximately 0.17.

Compare these theoretical figures for the standard deviations with those actually obtained as shown on the previous page.

Okay, now it's time that you checked the above claims based on data you obtain, rather than data presented to you.

In a moment you will roll four dice (or one die four times), find the mean of the four scores obtained, and note the result. Repeating this a further 99 times will give you 100 mean values, each from samples of size 4.

You can then check if your results agree with the above statements, i.e. is the mean of your 100 sample means close to 3.5, the mean of the distribution from which the samples are drawn, and is your standard deviation of the 100 means close to $\frac{1.7078}{\sqrt{4}}$?

Then you can check for sample sizes of 20, 50, ...

But first let us consider how best to proceed with this data collection.

One way would be to physically roll four dice, note the four scores, find the mean, record the result and then repeat the process until you have 100 sample means recorded.

Alternatively you could **simulate** such an activity using the random number generator of some calculators, spreadsheets or internet sites, as the next page explains.



iStock.com/ThomasVogel



Some calculators can randomly generate a list consisting of a specified number of integers in a given range, as the first line of the display shown on the right suggests. The second line then calculates the mean of these four numbers.

```
randList(4,1,6)           {5,5,4,1}
sum(ans) / 4              3.75
sum(randList(4,1,6)) / 4  2.5
```

Alternatively generate four numbers and find their mean 'in one go', as the third line suggests.

Twenty mean values generated in this way are shown below:

4 4 3 2.25 3.75 2.75 4.75 3.5 3.25 2.25
 3.25 3 4.25 3.5 3.25 3.75 4.75 3 2.5 3.25

These same twenty mean values presented as a frequency table:

Value	2.25	2.5	2.75	3	3.25	3.5	3.75	4	4.25	4.5	4.75
Frequency	2	1	1	3	4	2	2	2	1	0	2

Analysing these values with a calculator gives $\bar{x} = 3.4$, $\sigma_n = 0.7$, $\sigma_{n-1} = 0.718$.

Alternatively, using a computer spreadsheet:

RANDBETWEEN(1,6)

	A	B	C	D	E	F	G	H	I	J	K	L	M	N	O	P	Q	R	S	T	U
		5	5	6	5	6	2	6	4	2	4	3	5	3	3	6	4	3	2	4	5
		3	2	1	4	1	6	5	6	4	4	3	3	4	5	5	1	5	4	3	6
		3	3	3	5	5	6	5	3	1	4	5	2	6	3	6	1	3	1	2	4
		1	3	1	3	2	1	4	2	5	4	4	3	1	5	2	4	3	3	3	5
Mean		3	3.25	2.75	4.25	3.5	3.75	5	3.75	3	4	3.75	3.25	3.5	4	4.75	2.5	3.5	2.5	3	5
Mean	2.25	2.5	2.75	3	3.25	3.5	3.75	4	4.25	4.5	4.75	5									
Count	0	2	1	3	2	3	3	2	1	0	1	2									
Mean of sample means							3.6														
Standard deviation σ						n	0.73	n-1	0.75												

Calculators and spreadsheets can be instructed to display and analyse lists of random numbers, and their mean values, in a number of ways. There are also interactive websites that will display sample means. The reader is encouraged to investigate the capability of their own calculator, spreadsheets and the internet in this regard.

Now carry out the activity mentioned on the previous page:

- Find the mean score obtained for rolling four normal dice (simulated), and repeat this activity to give 100 such sample means (i.e. obtain 100 sample means for sample size 4), recording the sample means in a frequency table. Analyse your results and see if the sample means have a mean close to 3.5 and a standard deviation close to $\frac{1.7078}{\sqrt{n}}$, in this case for $n = 4$.
- Repeat the activity but now obtaining 100 sample means for sample size 20.
- Repeat the activity but now obtaining 100 sample means for sample size 50.



The graph below shows the distribution of sample means for one particular set of 100 samples of sample size 50. (The graph involves grouped data but the summary statistics shown have been calculated from the original 100 sample means.)

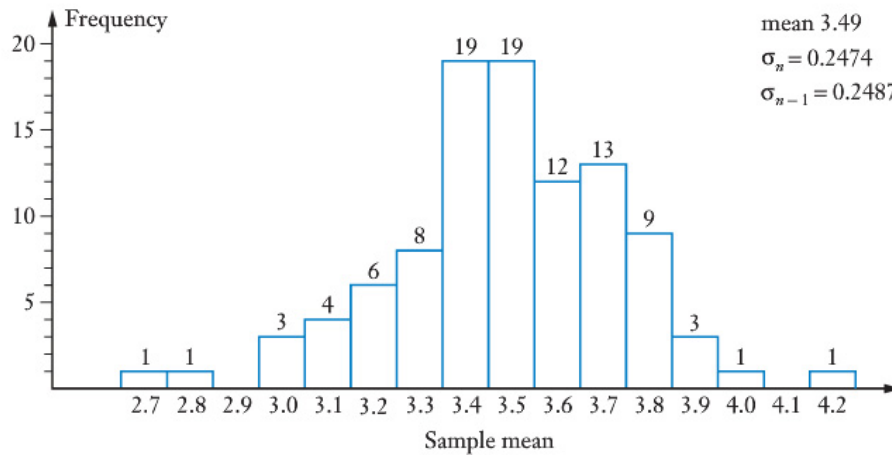

The graph below shows the distribution of sample means for one particular set of 100 samples of sample size 100. (The graph involves grouped data but the summary statistics shown have been calculated from the original 100 sample means.)

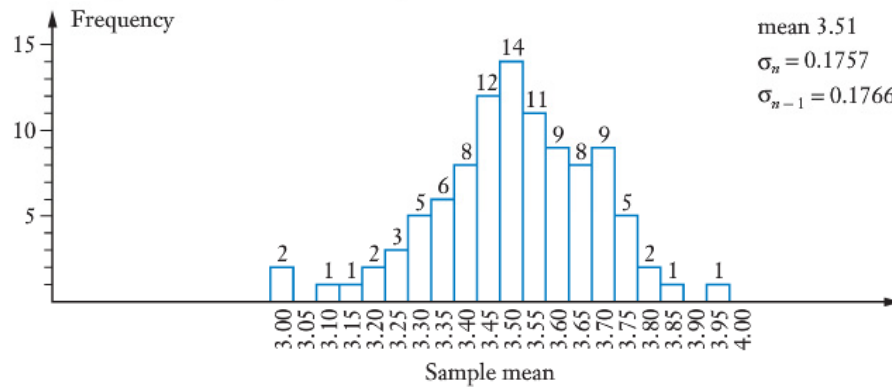

The central limit theorem

According to the central limit theorem, as the sample size, n , increases:

- the distribution of sample means approaches a normal distribution
- the mean of the sample means, \bar{x} , approaches the population mean
- the standard deviation of the sample means approaches $\frac{\sigma}{\sqrt{n}}$ where σ is the standard deviation of the population

We have seen that the above statements seem to be the case when the samples are drawn from a uniform distribution. Will they also be the case if the samples are drawn from other distributions, for example, the normal distribution itself?

Some calculators and spreadsheets can generate random numbers from normal distributions. Investigate sample means from such a distribution. Do the three bold statements above still seem to be the case?

Sample size

The central limit theorem applies irrespective of the type of distribution the samples are drawn from. However, note the following points regarding the sample size needed for the ‘approximation to normal’ to be valid.

- If the population from which our samples are drawn is not normally distributed then, as an approximate ‘rule of thumb’, we assume that for $n \geq 30$ the sample means can be well-modelled by a normal distribution.
- If the population from which our samples are drawn is normally distributed we can assume that the sample means will be normally distributed for all n .

EXAMPLE 1

Note: For the repeated rolling of a normal die we expect a long term mean of 3.5 and standard deviation 1.71.

A computer is used to simulate the rolling of a normal fair six-sided die 100 times and to calculate and record the mean of these 100 scores.

The computer carries out this process 250 times.

- a How would you expect the 250 mean scores to be distributed?
- b How would you expect the 250 mean scores to be distributed if instead the repeated simulation involved 200 rolls of the die?

Solution

We are sampling from a population with mean 3.5 and standard deviation 1.71.

- a The sample size is 100.

From the central limit theorem the sample means will be approximately normally distributed with a mean of 3.5 and a standard deviation of $\frac{1.71}{\sqrt{100}} = 0.171$.

- b The sample size is 200.

From the central limit theorem the sample means will be approximately normally distributed with a mean of 3.5 and a standard deviation of $\frac{1.71}{\sqrt{200}} = 0.121$.

Knowing that the sample means **form a distribution that is approximately normal** allows us to use our understanding of the normal distribution:

- to determine the likelihood of the mean of a particular sample lying in a given interval
- and
- to thereby gain some indication of whether a particular sample mean seems unexpectedly high or unexpectedly low.

EXAMPLE 2

A random variable X is known to have a mean of 65
and a standard deviation of 8.

A random sample involves 100 measurements of X .

What is the probability that the mean of such a sample is less than 64?

Solution

From the central limit theorem we can assume that the distribution of sample means will be approximately normal with mean 65 and standard deviation $\frac{8}{\sqrt{100}}$, i.e. the sample means are normally distributed with a mean of 65 and a standard deviation of 0.8.

Using a calculator, if $Y \sim N(65, 0.8^2)$
 $P(Y < 64) = 0.1056$

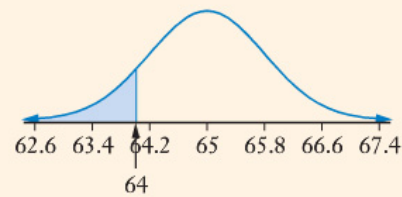

The probability that the mean of such a sample is less than 64 is approximately 0.11.

EXAMPLE 3

A random variable X is normally distributed with a mean of 27.6
and a standard deviation of 3.6.

A random sample involves 16 measurements of X .

What is the probability that the mean of such a sample is less than 27?

Solution

Whilst the sample size is small the sample means will be normally distributed because the population from which the sample is drawn is normally distributed. Thus the sample means will be normally distributed with mean 27.6 and standard deviation $\frac{3.6}{\sqrt{16}}$, i.e., $N(27.6, 0.9^2)$.

Using a calculator, if $Y \sim N(27.6, 0.9^2)$
 $P(Y < 27) = 0.2525$

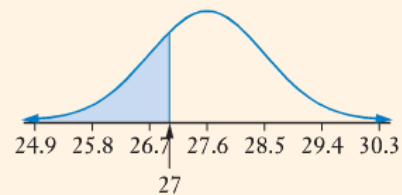

The probability that the mean of such a sample is less than 27 is approximately 0.25.



Samples with means that are unusually high or unusually low

From your studies of *Mathematics Methods* Unit Four you should be familiar with the **standard normal distribution** being a normal distribution with mean 0 and standard deviation 1, i.e. $Z \sim N(0, 1^2)$, and with its associated 'z scores'.

$$\begin{array}{l} \text{Solving} \quad P(Z < k) = 0.975 \\ \text{gives} \quad \quad k = 1.960 \end{array}$$

Thus for a normal distribution 95% of the distribution lies within 1.96 standard deviations of the mean.

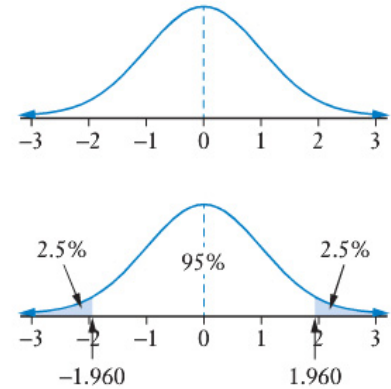

With the sample means belonging to a normal distribution, if a sample mean is found to lie further than 1.96 standard deviations from the mean of this distribution we may wonder if the sample is unusual in some way. (In such a case a possible course of action might be to carry out further sampling.)

When a sample mean is outside of this 95% interval we say that this particular sample mean is *significantly different* from the expected mean *at the 5% level*.

We say there is: **a significant difference at the 5% level.**

I.e., the fact that the mean of our sample is at one of the extremes, where we would expect only 5% of the sample means to lie, is significantly unusual.

EXAMPLE 4

A company manufacturing breakfast cereal claims that the weight of cereal in packets of a particular brand of their cereal, each claiming to contain 500 grams of the cereal, is normally distributed with mean 504.3 grams and standard deviation 2.1 grams.

An independent survey samples such packets of cereal to check this claim.

In each of the following cases, determine whether the sample mean is significantly different to the expected sample mean at the 5% level.

- a sample size 30, sample mean 504.9 g,
- b sample size 100, sample mean 504.9 g.

Solution

- a We would expect the sample means to be normally distributed with mean 504.3 g and standard deviation $\frac{2.1}{\sqrt{30}}$ g. Hence 95% of the sample means will lie between

$$504.3 - 1.96 \times \frac{2.1}{\sqrt{30}} \quad \text{and} \quad 504.3 + 1.96 \times \frac{2.1}{\sqrt{30}}$$

i.e. between 503.55 and 505.05.

With our sample mean of 504.9 g lying within this interval there is not a significant difference at the 5% level.

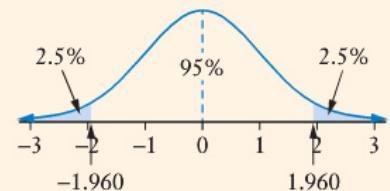

b We would expect the sample means to be normally distributed with mean 504.3 g and standard deviation $\frac{2.1}{\sqrt{100}}$ g. Hence 95% of the sample means will lie between

$$504.3 - 1.96 \times \frac{2.1}{\sqrt{100}} \quad \text{and} \quad 504.3 + 1.96 \times \frac{2.1}{\sqrt{100}}$$

i.e. between 503.89 and 504.71.

With our sample mean of 504.9 g lying outside of this interval there is a significant difference at the 5% level.

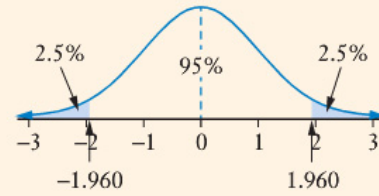

- Alternatively, rather than setting up the 95% interval, the above example could be answered by comparing $P(\text{mean} \geq 504.9 \text{ g})$ to 2.5% or by seeing how many standard deviations 504.9 g is from 504.3 g.
- The values for the central 95% interval can be determined directly from some calculators. Explore the ability of your calculator in this regard.

Exercise 12A

1 Note: For the repeated rolling of a normal die we expect a long-term mean of 3.5 and standard deviation 1.71.

A computer is used to simulate the rolling of a normal fair six-sided die 50 times and to calculate and record the mean of these 50 scores.

The computer carries out this task 200 times.

How would you expect the 200 mean scores to be distributed?

How would the distribution of means differ if instead the repeated simulation involved 150 rolls of the die each time?

2 If we define the random variable X as the number obtained from the spinner on the right, the probability distribution for X is as shown below.

x	1	2	3
$P(X = x)$	0.125	0.375	0.5



Use your calculator to confirm that the mean and standard deviation of this distribution are respectively 2.375 and 0.696 (to three decimal places).

The spinner is spun 60 times and the mean of the 60 numbers obtained is determined.

If this process were repeated a large number of times how would the mean values be distributed?

How would the distribution compare with the previous case if instead the process involved repeatedly calculating the mean of 100 spins?

- 3** If we define the random variable X as the number obtained when two normal dice are rolled and the numbers on the uppermost faces are added together, X has the probability distribution shown below:

x	2	3	4	5	6	7	8	9	10	11	12
$P(X = x)$	$\frac{1}{36}$	$\frac{1}{18}$	$\frac{1}{12}$	$\frac{1}{9}$	$\frac{5}{36}$	$\frac{1}{6}$	$\frac{5}{36}$	$\frac{1}{9}$	$\frac{1}{12}$	$\frac{1}{18}$	$\frac{1}{36}$

Use your calculator to confirm that the mean and standard deviation of this distribution are respectively 7 and 2.415 (to three decimal places).

A computer is used to simulate the rolling of two normal dice 36 times, each time recording the sum of the two numbers obtained, and then calculating the mean of the 36 numbers. The computer carries this simulation of 36 rolls of the two dice 100 times.

How would you expect the 100 mean scores to be distributed?

How would the distribution of the 100 means compare with the previous case if instead each simulation involved 120 rolls of the two dice rather than 36?



iStock.com/Arminiz

- 4** A random variable X is known to have a mean of 2145 and a standard deviation of 132.
A random sample involves 50 measurements of X .
What is the probability that the mean of such a sample is less than 2175?
- 5** A random variable X is known to have a mean of 16.8 and a standard deviation of 3.2.
A random sample involves 64 measurements of X .
What is the probability that the mean of such a sample is more than 17.5?
- 6** A random variable X is known to have a mean of 145 and a standard deviation of 20.
A random sample involves 100 measurements of X .
What is the probability that the mean of such a sample lies between 144 and 150?
- 7** A random variable, X , is such that $X \sim N(5, 1)$.
The random variable Y is the mean of 25 random measurements of X .
a What will be the distribution of Y ?
b Find $P(Y \geq 5.5)$.
- 8** A random variable, X , is such that $X \sim \text{Bin}(50, 0.6)$.
The random variable Y is the mean of 50 random measurements of X .
What will be the distribution of Y ?
Note: $\text{Bin}(n, p)$ has mean np and standard deviation \sqrt{npq} where $q = (1 - p)$.

- 9** For a particular brand of breakfast cereal the weight of cereal in packets that claim to contain 500 grams is actually normally distributed with a mean of 508 g and standard deviation 3 g.
- What percentage of packets will contain less than 500 g?
 - What percentage of packets will contain more than 510 g?
 - A random sample of 10 packets is selected and the weight of cereal in each packet is measured. What is the probability that the mean of these ten weights is 508 grams when rounded to the nearest gram?
- 10** A company claims that the weights of its 1 kg bags of tomatoes are normally distributed with mean 1.015 kg and standard deviation 0.006 kg.
Assuming that the company's claim is true:
- What is the probability of a randomly-chosen bag containing less than 1 kg?
 - What is the probability of a randomly-chosen bag containing more than 1.02 kg?
 - If five bags are randomly selected what is the probability that the mean weight of the five bags will be between 1.01 kg and 1.02 kg?
- 11** Scientists feel confident that the population of adult male lizards of a particular species have lengths that are normally distributed with a mean of 17.4 cm and standard deviation 2.1 cm. A sample of ten adult male lizards of this species are caught and their lengths measured. The mean length of this sample of ten is found to be 19.4 cm.
Comment upon this result.

- 12** A continuous random variable X is uniformly distributed on the interval $84 \rightarrow 90$.

a Find $P(88 < X < 90)$.

- b** Use the fact that a continuous random variable, uniformly distributed between the values a and b , has a standard deviation of $\frac{b-a}{\sqrt{12}}$ to determine the standard deviation of X .

- c** The random variable Z is the mean of 48 randomly chosen values of X . Find $P(Z > 87.5)$.

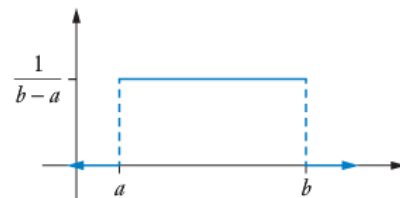
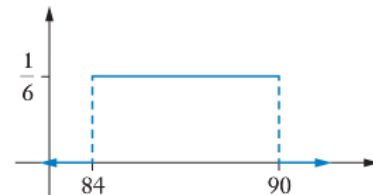

- 13** For a large sample of given size the population of sample means is normally distributed. If we take a sample of this size and find that the mean of the sample lies further than 1.96 standard deviations from the mean of this normal distribution we say that there is *a significant difference at the 5% level*.

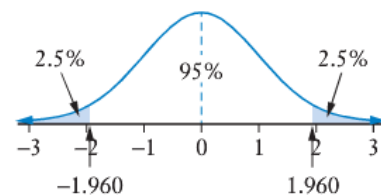

A continuous random variable X has mean 513 and standard deviation 26. Values of X are randomly sampled. For each of the following determine, with reasoning, whether there is *a significant difference at the 5% level*.

- First sample taken: Sample size 64, sample mean 505.
- Second sample taken: Sample size 100, sample mean 510.





Inferring population parameters from sample statistics

If we wish to use a sample to estimate the mean of the population from which the sample was drawn we could simply assume the population mean to be the same as the sample mean. However, we do have a problem with doing this because we would expect there to be some variation in sample means. If we used a different sample, drawn from the same population, we would have a different sample mean and therefore a different estimate of the population mean. However, from the central limit theorem, we know that sample means from large samples will be normally distributed, or approximately normally distributed. Hence we can use our understanding of the normal distribution to give a range of values that we can, with a particular level of confidence, expect the population mean to lie within.

First let us revisit the **standard normal distribution**, i.e. $Z \sim N(0, 1^2)$, with its associated 'z scores' and establish some important numbers relating to the 90%, 95% and 99% confidence levels (one of which we used when considering samples with means that were unusually high or unusually low).

For a 90% confidence interval

Solving $P(Z < k) = 0.95$
gives $k = 1.6449$

90% of the scores from a normal distribution lie within 1.645 standard deviations of the mean.

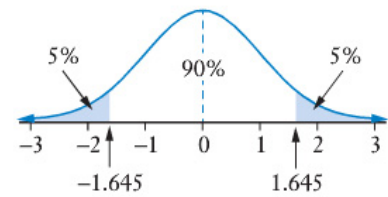

For a 95% confidence interval

Solving $P(Z < k) = 0.975$
gives $k = 1.9600$

95% of the scores from a normal distribution lie within 1.960 standard deviations of the mean.

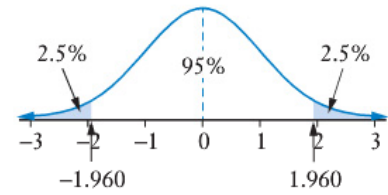

For a 99% confidence interval

Solving $P(Z < k) = 0.995$
gives $k = 2.5758$

99% of the scores from a normal distribution lie within 2.576 standard deviations of the mean.

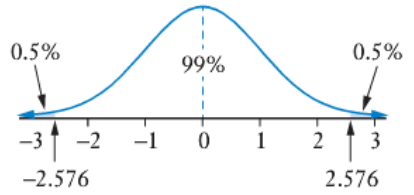

Shutterstock.com / Denis Cristo



From the central limit theorem we know that the mean of our single sample comes from a distribution of sample means that approximate a normal distribution with a mean equal to the mean of the population. Hence we can be 90% confident that our sample mean is within 1.645 standard deviations of the population mean, (1.645 being the critical score for the 90% confidence interval). Therefore:

*We can be 90% confident that the population mean is within
1.645 standard deviations of the sample mean.*

(If A is within 1.645 units of some fixed value B then B is within 1.645 units of A.)

Similarly:

*We can be 95% confident that the population mean is within
1.960 standard deviations of the sample mean.*

and

*We can be 99% confident that the population mean is within
2.576 standard deviations of the sample mean.*

If σ is the population standard deviation then the standard deviation referred to in each of the three previous italicised statements is $\frac{\sigma}{\sqrt{n}}$.

If we do not know the population standard deviation we can use the standard deviation of our sample as an estimate of the population standard deviation. Remember that calculators usually give two standard deviation values, σ_n and σ_{n-1} , or σ_x and s_x , the second of these being a little larger than the first. It is this second one, σ_{n-1} or s_x (called the *sample standard deviation*) that is used as an estimate for the population standard deviation as its slightly larger value allows for the fact that the variation in the sample slightly underestimates the variation in the population as a whole.

Thus, to infer the mean, μ , and standard deviation, σ , of a population from the mean, \bar{x} , and sample standard deviation, s_x , of a sample:

- assume that the standard deviation of the population, σ , is equal to s_x (i.e. σ_{n-1}), the sample standard deviation.
- use the fact that our sample mean comes from a normal distribution with mean μ and standard deviation $\frac{\sigma}{\sqrt{n}}$ to say that μ lies in the interval

$$\bar{x} - k \frac{\sigma}{\sqrt{n}} \leq \mu \leq \bar{x} + k \frac{\sigma}{\sqrt{n}}$$

where k is the appropriate number of standard deviations for the required confidence interval,

i.e., to 3 decimal places, $k = 1.645$ for a 90% confidence interval
 $k = 1.960$ for a 95% confidence interval
 and $k = 2.576$ for a 99% confidence interval.



EXAMPLE 5

A random sample of 50 'top-grade' ripe plums of a particular species has a mean weight of 125 grams and a sample standard deviation of 12 grams.

Determine the 95% confidence interval for the mean weight of the population.

Solution

Not knowing the standard deviation of the population we use the sample standard deviation as an estimate of the population standard deviation, i.e. 12 grams.

Thus if μ is the population mean, for the 95% confidence interval we use

$$\bar{x} - k \frac{\sigma}{\sqrt{n}} \leq \mu \leq \bar{x} + k \frac{\sigma}{\sqrt{n}}$$

with $\bar{x} = 125$ grams, $k = 1.960$, $\sigma = 12$ grams and $n = 50$.

Thus $121.67 \text{ g} \leq \mu \leq 128.33 \text{ g}$

The 95% confidence interval for the population mean is 121.7 g to 128.3 g.

- Note
- It could be argued that any rounding should be such that it does not decrease the interval. The final statement of the answer in the previous example would then be stated as $121.6 \text{ g} \leq \mu \leq 128.4 \text{ g}$.

The answers in this text will ignore this technicality and will give answers rounded in the usual way.

- Some calculators can determine confidence intervals, as the display below suggests.

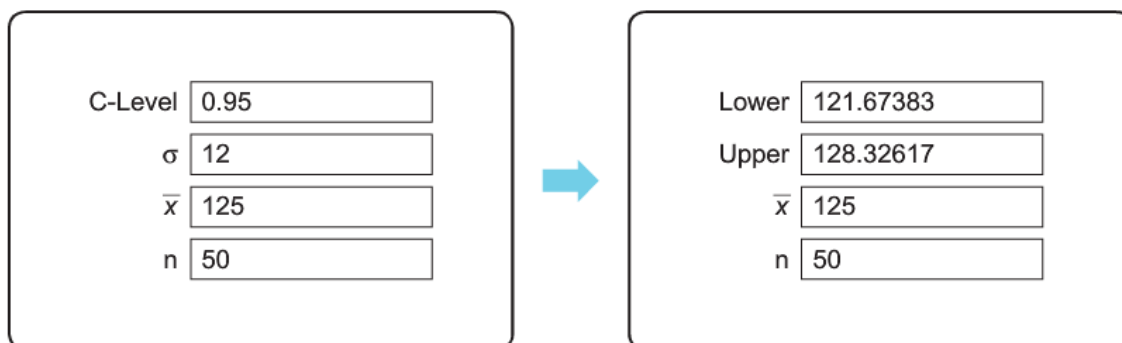

- The 95% (or 90% or 99%) confidence interval tells us that if we were to construct confidence intervals in this way then we would expect 95% (or 90% or 99%) of them to contain the population mean.
- If we are told the standard deviation of the population we would use that, not the sample standard deviation, in our calculation of confidence intervals for the mean of the population.



EXAMPLE 6

A sample of thirty-six 20 kg bags of cement has a mean weight of 20.095 kg and sample standard deviation 42 grams. Find the 99% confidence interval for the mean weight of the population.

Solution

Not knowing the standard deviation of the population we use the sample standard deviation as an estimate of the population standard deviation, i.e. we use 42 grams.

Thus if μ is the population mean, for the 99% confidence interval we use

$$\bar{x} - k \frac{\sigma}{\sqrt{n}} \leq \mu \leq \bar{x} + k \frac{\sigma}{\sqrt{n}}$$

with $\bar{x} = 20.095$ kg, $k = 2.576$,
 $\sigma = 0.042$ kg and $n = 36$.

Thus 20.077 kg $\leq \mu \leq 20.113$ kg

The 99% confidence interval for the population mean μ is

$$20.077 \text{ kg} \leq \mu \leq 20.113 \text{ kg}.$$

zInterval 0.042,20.095,36,0.99

"Title"	"z Interval"
"CLower"	20.076969
"CUpper"	20.113031
" \bar{x} "	20.095
"ME"	0.01803081
"n"	36
" σ "	0.042

EXAMPLE 7

The lengths of ten adult moths of a certain species were determined and the mean length was found to be 5.2 cm, sample standard deviation 0.3 cm. Given that the lengths of the adults of this species of moth are normally distributed determine the 95% confidence interval for μ , the mean length of this population of adult moths, and explain what your answer means.

Solution

Though our sample size of just ten is small the sample means will be normally distributed because the population from which the sample is taken is normally distributed.

Not knowing the standard deviation of the population we will use the sample standard deviation, i.e. 0.3 cm.

Thus if μ cm is the population mean, for the 95% confidence interval we use

$$\bar{x} - k \frac{\sigma}{\sqrt{n}} \leq \mu \leq \bar{x} + k \frac{\sigma}{\sqrt{n}}$$

with $\bar{x} = 5.2$ cm, $k = 1.96$,
 $\sigma = 0.3$ cm and $n = 10$.

Thus 5.014 cm $\leq \mu \leq 5.386$ cm

The 95% confidence interval for the population mean length is

$$5.01 \text{ cm to } 5.39 \text{ cm}.$$

zInterval 0.3,5.2,10,0.95

"Title"	"z Interval"
"CLower"	5.0140615
"CUpper"	5.3859385
" \bar{x} "	5.2
"ME"	0.18593851
"n"	10
" σ "	0.3

We can be 95% confident that the mean lengths of adult moths of this species lies between 5.01 cm and 5.39 cm (because 95% of the 95% confidence intervals constructed in this way would contain the population mean).



Exercise 12B

- 1 If we use a given sample of size $n > 30$, mean \bar{x} and sample standard deviation s , to determine confidence intervals for the population mean, which has the smaller width – the 90% confidence interval or the 95% confidence interval?
- 2 If we use a given sample of size $n > 30$, mean \bar{x} and sample standard deviation s , to determine confidence intervals for the population mean, which has the smaller width – the 95% confidence interval or the 99% confidence interval?
- 3 Two different sized samples, taken from the same population, have the same mean value. The population standard deviation is known.
If the sample mean and population standard deviation are used to determine the 95% confidence interval for the mean of the population, which sample will give the narrower confidence interval – the bigger size sample or the smaller size sample?
- 4 Find the 90% confidence interval for the mean of the population given that a sample of size 100 taken from this population had a mean of 573 cm and a sample standard deviation of 48 cm. (Give interval boundaries to the nearest centimetre.)
- 5 Find the 95% confidence interval for the mean of the population given that a sample of size 50 taken from this population had a mean of 26.14 kg and a sample standard deviation of 3.67 kg. (Give interval boundaries to the nearest 0.01 kg.)
- 6 Find the 99% confidence interval for the mean of the population given that a sample of size 80 taken from this population had a mean of 17.2 cm and a sample variance of 5.76 cm.
- 7 The lengths of ten 12-month-old baby girls were recorded and the mean length was found to be 74.6 cm, sample standard deviation 1.4 cm. Given that the lengths of 12-month-old baby girls are normally distributed determine the 95% confidence interval for μ , the mean length of 12-month-old baby girls. Explain what your confidence interval means.
- 8 A random sample of 40 three-month-old seedlings of a particular plant type had a mean height of 17.8 cm, sample standard deviation 2.4 cm.
Determine a 90% confidence interval for the mean height of three-month-old seedlings of this plant type and explain what this confidence interval means.
- 9 A random sample of 200 birds of a particular species had a mean wing span of length 18.3 cm, sample standard deviation 2.7 cm.
Use this information to determine a 95% confidence interval for the mean wing span for the entire population of birds of this species.
Had the same mean and sample standard deviation come from a random sample of 300 birds of this species instead, what would the 95% confidence interval be now?



Shutterstock.com/Sergio33

So do most 95% confidence intervals really contain the population mean? Let's check

The following statement was made a few pages earlier:

The 95% (or 90% or 99%) confidence interval tells us that if we were to construct confidence intervals in this way then we would expect 95% (or 90% or 99%) of them to contain the population mean.

Let's check this using a situation for which we know what the population mean is.

If we could roll a die an infinite number of times, and find the mean score obtained we know that in theory the mean would be 3.5 and standard deviation 1.7078. Suppose we did not know these figures. Would the 95% confidence intervals, constructed from samples that we take, contain the population mean as we claim?

Using a computer or calculator spreadsheet simulate 100 such rolls and determine the mean and the standard deviation.

The display on the right shows a sample mean for such a simulation as 3.25 and sample standard deviation, s_x , as 1.7019.

Thus to estimate the population mean, μ , using the 95% confidence interval, we use

$$\bar{x} - k \frac{\sigma}{\sqrt{n}} \leq \mu \leq \bar{x} + k \frac{\sigma}{\sqrt{n}}$$

with $\bar{x} = 3.25$, $k = 1.96$, $\sigma = 1.7019$ and $n = 100$.

Thus $2.916 \leq \mu \leq 3.584$

We can be 95% confident that the population mean lies between 2.916 and 3.584, i.e. in the interval 3.25 ± 0.334 .

	A	B	C
1	2		
2	5		
3	3		
4	1		
5	1		
6	6		

=int(rand()*6+1)

$\bar{x} = 3.25$
 $\Sigma x = 325$
 $\Sigma x^2 = 1343$
 $\sigma_x = 1.6933694$
 $s_x = 1.7019003$
 $n = 100$

C-Level

σ

\bar{x}

n



Lower

Upper

\bar{x}

n

The known population mean does indeed lie in the 95% confidence interval obtained from this sample.

Note: The population mean of 3.5 and standard deviation of 1.7078 gives a 95% interval of 3.5 ± 0.3347 , but we would not normally know these figures.

Use a spreadsheet to produce 50 such samples of 100 rolls of a die and see how many of the 50 produce 95% confidence intervals that do contain 3.5, our known population mean.



Choosing the sample size

The fact that, with a particular level of confidence, we can say the population mean, μ , lies in the interval

$$\bar{x} - k \frac{\sigma}{\sqrt{n}} \leq \mu \leq \bar{x} + k \frac{\sigma}{\sqrt{n}}$$

can be used to determine the required sample size, n , needed to give us a confidence interval of a desired width for the particular confidence level.

EXAMPLE 8

A random sample is to be taken from a random variable with population standard deviation of 5 units.

If we want to be 95% confident that the mean of the sample is within 1.7 units of the population mean how large should the sample be?

Solution

Writing the sample mean as \bar{x} and the population mean as μ we have, for the 95% confidence interval

$$\bar{x} - 1.96 \times \frac{\sigma}{\sqrt{n}} \leq \mu \leq \bar{x} + 1.96 \times \frac{\sigma}{\sqrt{n}}$$

Thus we require
$$1.96 \times \frac{5}{\sqrt{n}} = 1.7$$

Solving gives
$$n = 33.2$$

We need to be *within* 1.7 units so we need to round n up. Hence the sample size needs to be 34.

EXAMPLE 9

An earlier sample of 1 litre bottles of a particular type of fruit drink suggests that the amount of fruit juice in each litre of the fruit drink is distributed with a mean of 153 millilitres and standard deviation 6.4 millilitres.

A new sample is to be carried out for which we want to be 99% confident that the mean of the sample is within 2 millilitres of the population mean. How large should the sample be?

Solution

Writing the sample mean as \bar{x} and the population mean as μ we have, for the 99% confidence interval

$$\bar{x} - 2.576 \times \frac{\sigma}{\sqrt{n}} \leq \mu \leq \bar{x} + 2.576 \times \frac{\sigma}{\sqrt{n}}$$

Thus we require
$$2.576 \times \frac{6.4}{\sqrt{n}} = 2$$

Solving gives
$$n = 67.95$$

We want to be *within* 2 millilitres so we need to round n up. Hence the sample size needs to be 68.



Exercise 12C

- 1** A random sample is to be taken from a random variable with population standard deviation of 8 units.

If we want to be 95% confident that the mean of the sample is within 1.5 units of the population mean how large should the sample be?

- 2** A random sample is to be taken from a random variable with population standard deviation of 18.7 units.

If we want to be 99% confident that the mean of the sample is within 2.5 units of the population mean how large should the sample be?

- 3** A random sample is to be taken from a random variable with a normally distributed population, standard deviation 7.3 units.

If we want to be 95% confident that the mean of the sample is within 3 units of the population mean how large should the sample be?

- 4** A random sample of 30 measurements of a random variable is taken in order to have some idea of the standard deviation of the variable.

The sample standard deviation of this sample was found to be 8.4 units.

If we assume that this standard deviation is also the standard deviation of the random variable, find the sample size needed for a second sample if we want to be 90% confident that the mean of this second sample is within 2 units of the population mean.

- 5** A previous sample involving measuring the lengths of 30 adult snakes of a particular species found that the lengths were distributed with a mean of 28.4 cm and sample standard deviation 3.6 cm.

A new sample is to be taken for which the investigators want to be 95% confident that the mean length of this second sample is within 0.5 cm of the population mean.

Assuming the standard deviation of the lengths of the population is the same as the sample standard deviation of the lengths in the first sample, what should be the size of this second sample?

- 6** A drink dispenser is programmed to dispense quantities with a mean volume of 250 mL, standard deviation 3 mL.

With age, dispensers of this type are known to start dispensing amounts that no longer have a mean volume of 250 mL, though the standard deviation tends to remain at 3 mL.

A fresh sample of dispensed amounts is to be checked to allow an estimate to be made of the mean volume dispensed.

If we want to be 95% confident that the mean volume being dispensed is within 1 mL of our sample mean, how many 'dispenses' should we include in our sample?



iStock.com/4kodiak

Miscellaneous exercise twelve

This miscellaneous exercise may include questions involving the work of this chapter, the work of any previous chapters in this unit, and the ideas mentioned in the Preliminary work section at the beginning of this unit.

1 Find an expression for $\frac{dC}{dx}$ for each of the following cost functions.

a $C(x) = 300 + 7x$

b $C(x) = 500 + 4x + x^2$

c $C(x) = \frac{x^3}{12} - 12x^2 + 800x + 1000$

d $C(x) = 60 + 4\sqrt{x} - \frac{1000}{x}$

2 Find an expression for $\frac{dy}{dx}$ as a function of x given that $x^3 + 2x^2y + y^3 = 10$.

3 If $y^4 = x^4 - 4xy - 7$ find

a an expression for $\frac{dy}{dx}$,

b the gradient at the point (2, 1).

4 The three slope fields shown below have their associated differential equations included in the following list. Choose the correct equation for each slope field.

$$\frac{dy}{dx} = 2y$$

$$\frac{dy}{dx} = y$$

$$\frac{dy}{dx} = x$$

$$\frac{dy}{dx} = \frac{x-3}{y-2}$$

$$\frac{dy}{dx} = (x-2)(y-3)$$

$$\frac{dy}{dx} = (x-3)(y-2)$$

Slope field A

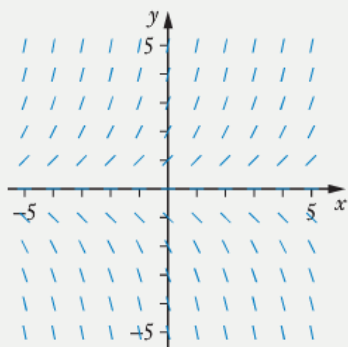

Slope field B

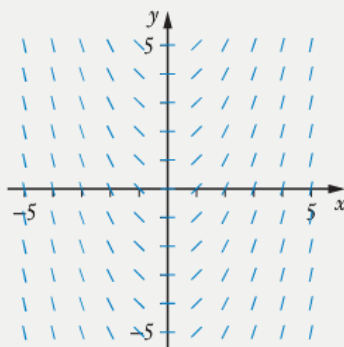

Slope field C

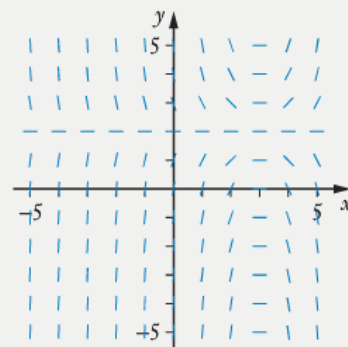

5 Clearly showing your use of the technique of expressing an algebraic fraction as partial fractions, determine:

$$\int \frac{3x^3 + 6x^2 - 4x - 8}{(x+1)(x^2-2)} dx.$$

6 Find an expression in terms of k (not left as a definite integral) for the *exact* area between the x -axis and the curve $y = 3 \sin^2 x \cos x$ from $x = 0$ to $x = k$ where

a $0 < k < \frac{\pi}{2}$

b $\frac{\pi}{2} < k < \pi$.

- 13** If $\frac{dy}{dx} = xe^x$ use the incremental formula to determine the approximate change in y when x changes from 1.25 to 1.26.
- 14** The diagram, not drawn to scale, shows a lamppost, AB, of height 9 metres, situated on one side of a straight road.

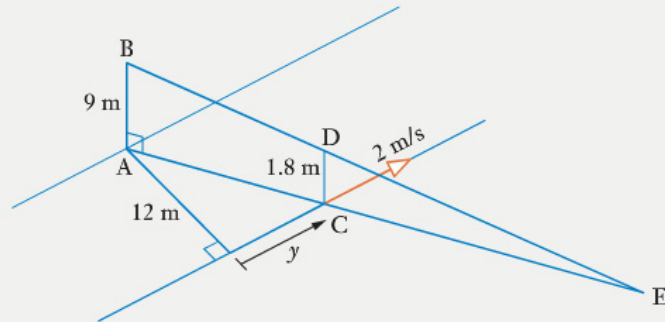

The road is of width 12 metres and line CD (see diagram) represents a person of height 1.8 metres walking at 2 metres/second along the other side of the road from the lamp. The light at B causes the person to have a shadow shown as CE.

Find the rate at which the length of the shadow is changing at the instant when AC is of length 20 metres.

- 15** An aircraft is following a flightpath that will take it directly over a searchlight at A (see diagram).

The speed of the aircraft is 200 m/s and it maintains a steady altitude of 800 metres.

At what rate must the searchlight be rotating at the instant when the aircraft is 1 km from A, measured horizontally, if it is to keep the aircraft in the light beam?

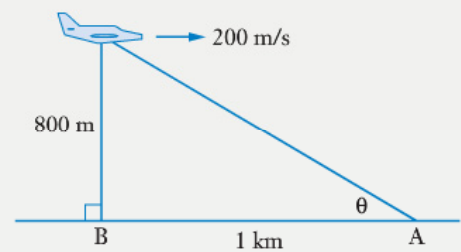

iStock.com/Starblast

- 16** A processing company processes a particular ore in one-tonne ‘batches’. Previous statistics from the company indicate that the amounts of a particular element extracted from the one tonne batches are normally distributed with a mean of 78 kg and standard deviation 12 kg.
- What is the probability of more than 100 kg of the particular element being extracted from a randomly selected one tonne batch?
 - What is the probability of between 70 kg and 90 kg of the particular element being extracted from a randomly selected one tonne batch?
 - If 4 separate batches are sampled and the amount of the element extracted from each is noted, what is the probability that the mean of these four amounts will be less than 75 kg?

- 17** The shape of the interior of a particular flower vase is the same as that formed by rotating about the y -axis the area in the first quadrant that is enclosed between the x -axis, the y -axis, $y = x^2 - 4$ and $y = h$ ($h > 0$). With one centimetre to one unit on each axis determine the value of h , to the nearest centimetre, if the capacity of the vase is 2.5 L.

If water were poured into this vase at a constant rate of $5 \text{ cm}^3/\text{second}$, find the rate at which the water level is rising when the depth of water in the vase is 6 cm.

- 18** At 1.30 p.m. a police doctor arrives at a house where a suspicious death has occurred. Upon arrival the doctor takes the temperature of the corpse and finds it to be 28.6°C . By 2.30 p.m. the temperature of the corpse is 27.7°C .

The house is air-conditioned so the room temperature may be assumed to have been 22°C all day.

According to Newton’s law of cooling, if the temperature of an object exceeds that of its surroundings by $T^\circ\text{C}$ then the rate of change of T is proportional to T itself. If normal body temperature is 37°C estimate the time at which the suspicious death occurred.

- 19 a** Let us suppose that the standard deviation of h , the time, in hours, of ‘non-stop operation before requiring recharging’, of a particular electrical component made by company A is 80 hours.

The engineers from a space program wish to estimate the mean value of h by sampling a number of these components and running them non-stop until recharging is required, before deciding whether to use them in their space vehicle.

The engineers want to be 95% confident that the mean value of h for their sample is within 20 hours of the population mean.

How large should their sample be?

- b** A second company, company B, also makes the component and they claim that for their components, h is normally distributed with a mean of 1850 hours and standard deviation 65 hours.

The space program engineers sample 100 of these company B components and find that for their sample the sample standard deviation of h is indeed very close to 65 hours but the mean for the sample is 1800 hours.

Comment on this result including in your comment mention of the 95% confidence interval.

- 20** Without the assistance of your calculator, determine $\int \frac{2x^3 + 3x^2 - 24x - 29}{x^3 - 7x - 6} dx$.



ANSWERS

UNIT THREE

Exercise 1A PAGE 3

- 1 a** $8i$ **b** $2\sqrt{2}i$ **c** $\sqrt{10}i$ **d** $3\sqrt{7}i$
2 a -5 **b** 3
3 a 12 **b** -5
4 a $\frac{3}{2} + \frac{\sqrt{3}}{2}i, \frac{3}{2} - \frac{\sqrt{3}}{2}i$ **b** $-2 + \sqrt{3}i, -2 - \sqrt{3}i$
c $\frac{1}{6} + \frac{\sqrt{11}}{6}i, \frac{1}{6} - \frac{\sqrt{11}}{6}i$ **d** $-0.8 + 0.4i, -0.8 - 0.4i$
5 $5 + 6i$ **6** -2 **7** $10 - i$
8 $9 + 3i$ **9** $8 - 2i$ **10** $2i$
11 $7 - 6i$ **12** $17 + 6i$ **13** 2
14 -5 **15** $16 + 11i$ **16** $7 + 9i$
17 5 **18** $53i$ **19** $-0.8 - 1.4i$
20 $-\frac{5}{13} - \frac{12}{13}i$ **21** $\frac{7}{25} - \frac{26}{25}i$ **22** $-0.2 + 0.4i$
23 a $7 + 2i$ **b** $-3 + 4i$ **c** $-10 + 19i$
d $13 + 13i$ **e** $24 - 10i$ **f** $\frac{7}{26} + \frac{17}{26}i$
24 a $4 + 7i$ **b** 8
c 65 **d** $-\frac{33}{65} - \frac{56}{65}i$
25 $a = -34$ and $b = 5$ **26** $a = 10$ and $b = 25$
27 b $p = -4, q = 13$ **c** $d = -6, e = 13$
28 a $(2, 3)$ **b** $(-3, 0)$
c $(4, 2)$ **d** $\left(-\frac{37}{169}, -\frac{55}{169}\right)$
29 $a = 6$ and $b = 0.5$ or $a = 1$ and $b = 3$

Exercise 1B PAGE 8

- 1** $p = -38$ **2** $a = 2, b = 1, c = 5, d = 8$
3 a -3 **b** -3
4 a 8 **b** 8
5 4 **6** -5 **7** $a = 1, b = 3$
8 a $f(-1) = -16, f(1) = 0.$
b $x = 1, x = 1 + 2i, x = 1 - 2i.$
c $x = 0, x = 1, x = 1 + 2i, x = 1 - 2i.$
9 a $f(-2) = 0, f(2) = -36, f(-5) = 1140, f(5) = 0.$
b $x = -2, x = 5, x = 1 + \sqrt{2}i, x = 1 - \sqrt{2}i.$
10 a $f(1) = 2, f(0.5) = 0.$ **b** $x = 0.5, x = -i, x = i.$
11 $x = -1 + i, x = -1 - i, x = 1 - 2i, x = 1 + 2i.$
12 $x = 1, x = \frac{1 + 3\sqrt{7}i}{4}, x = \frac{1 - 3\sqrt{7}i}{4}.$
13 $x = -1, x = 0, x = \frac{3 + \sqrt{3}i}{3}, x = \frac{3 - \sqrt{3}i}{3}.$

Miscellaneous exercise one PAGE 9

- 1 a** 58 **b** 26 **c** $12 - 5i$
d $-24 - 10i$ **e** $\frac{4}{5} - \frac{7}{5}i$ **f** $-\frac{1}{5} + \frac{2}{5}i$
2 a $-1 + i$ **b** $8 + 31i$ **c** $3 + 4i$
d $-7 - 24i$ **e** $8 - 31i$ **f** $8 - 31i$
g $q = -4 + 4i$
3 $-4 - 4i$
4 18
5 a 6 **b** 8
6 0



7 $a = -1, b = 2, c = -3, d = 6$

8 $p = q = -11$

9 **a** $6i - 2j$ **b** $\sqrt{2}(i + 2j)$ **c** $d = \pm 3$
d 2 **e** 82°

10 **b** $= -a$ **c** $= 2a$ **d** $= 0.5a$
e $= -0.5a$ **f** $= 1.5a$ **g** $= -1.5a$

11 **r** $= p + q$ **s** $= 0.5p + q$ **t** $= p + 2q$
u $= -1.5p - q$

12 $x = 2, x = -4 + 2i, x = -4 - 2i$

13 **a** $= \pm 2$ **b** $= 2$ **c** $= -7$
d $= 1$ **e** $= 5$ **f** $= -5$

Exercise 2A PAGE 15

1 **a** 5 **b** 13 **c** $\sqrt{13}$
d $\sqrt{13}$ **e** $\sqrt{26}$ **f** 5

2 **a** $\frac{\pi}{4}$ **b** $-\frac{\pi}{4}$ **c** $\frac{3\pi}{4}$
d $-\frac{3\pi}{4}$ **e** $\frac{2\pi}{3}$ **f** $-\frac{\pi}{3}$

3 $z_1 = 3\left(\cos\frac{\pi}{6} + i\sin\frac{\pi}{6}\right)$

$z_2 = 3(\cos\pi + i\sin\pi)$

$z_3 = 4\left(\cos\left(-\frac{3\pi}{4}\right) + i\sin\left(-\frac{3\pi}{4}\right)\right)$

$z_4 = 2(\cos\pi + i\sin\pi)$

$z_5 = 6(\cos 1 + i\sin 1)$

$z_6 = 5\left(\cos\frac{3\pi}{4} + i\sin\frac{3\pi}{4}\right)$

$z_7 = 8\left(\cos\left(-\frac{5\pi}{6}\right) + i\sin\left(-\frac{5\pi}{6}\right)\right)$

$z_8 = 5\left(\cos\left(-\frac{\pi}{2}\right) + i\sin\left(-\frac{\pi}{2}\right)\right)$

$z_9 = 6(\cos 2 + i\sin 2)$

$z_{10} = 4(\cos\pi + i\sin\pi)$

$z_{11} = 5\left(\cos\left(-\frac{3\pi}{4}\right) + i\sin\left(-\frac{3\pi}{4}\right)\right)$

$z_{12} = 7\left(\cos\left(-\frac{\pi}{6}\right) + i\sin\left(-\frac{\pi}{6}\right)\right)$

4 $z_{13} = 5\sqrt{2}\left(\cos\frac{\pi}{4} + i\sin\frac{\pi}{4}\right)$

$z_{14} = 5(\cos 2.2143 + i\sin 2.2143)$

$z_{15} = \sqrt{41}(\cos(-2.2455) + i\sin(-2.2455))$

$z_{16} = 5\sqrt{2}\left(\cos\left(-\frac{\pi}{4}\right) + i\sin\left(-\frac{\pi}{4}\right)\right)$

$z_{17} = 13(\cos 1.1760 + i\sin 1.1760)$

$z_{18} = 5\sqrt{2}(\cos 1.4289 + i\sin 1.4289)$

$z_{19} = 5\sqrt{2}(\cos(-1.4289) + i\sin(-1.4289))$

$z_{20} = 5\sqrt{2}(\cos 2.9997 + i\sin 2.9997)$

$z_{21} = 10\left(\cos\frac{\pi}{6} + i\sin\frac{\pi}{6}\right)$

$z_{22} = 4\left(\cos\frac{\pi}{2} + i\sin\frac{\pi}{2}\right)$

$z_{23} = 4(\cos 0 + i\sin 0)$

$z_{24} = 4(\cos\pi + i\sin\pi)$

$z_{25} = 3\left(\cos\left(-\frac{\pi}{2}\right) + i\sin\left(-\frac{\pi}{2}\right)\right)$

$z_{26} = 3(\cos 0 + i\sin 0)$

5 $z_{27} = \sqrt{2} + \sqrt{2}i, \quad z_{28} = -2\sqrt{3} + 2i,$

$z_{29} = 2 - 2\sqrt{3}i, \quad z_{30} = -3 - 3\sqrt{3}i,$

$z_{31} = 5 + 0i, \quad z_{32} = 0 - i$

Exercise 2B PAGE 17

1 $z_1 = 3 \operatorname{cis} \frac{\pi}{3} \quad z_2 = 5 \operatorname{cis} \frac{2\pi}{3}$

$z_3 = 4 \operatorname{cis} \left(-\frac{5\pi}{6}\right) \quad z_4 = 5 \operatorname{cis} \left(-\frac{\pi}{2}\right)$

$z_5 = 4 \operatorname{cis} 0 \quad z_6 = 5 \operatorname{cis} \frac{\pi}{2}$

$z_7 = 5 \operatorname{cis} \frac{3\pi}{4} \quad z_8 = 3 \operatorname{cis} \left(-\frac{3\pi}{4}\right)$

2 $2 \operatorname{cis} \frac{\pi}{10} \quad 3 \quad 7 \operatorname{cis} \frac{5\pi}{8} \quad 4 \quad 9 \operatorname{cis} \frac{\pi}{6}$

5 $3 \operatorname{cis} \left(-\frac{\pi}{6}\right) \quad 6 \quad 5 \operatorname{cis} \left(-\frac{\pi}{2}\right) \quad 7 \quad 4 \operatorname{cis} \frac{2\pi}{3}$

8 $2 \operatorname{cis} \frac{\pi}{3} \quad 9 \quad 2 \operatorname{cis} \pi \quad 10 \quad 7i$

11 $-5i \quad 12 \quad -1 \quad 13 \quad 3$

14 $5\sqrt{2} + 5\sqrt{2}i \quad 15 \quad -2 + 2\sqrt{3}i$

16 $-2 - 2\sqrt{3}i \quad 17 \quad -6 + 6\sqrt{3}i$

18 $25 \operatorname{cis}(1.8546) \quad 19 \quad 13 \operatorname{cis}(1.9656)$

20 $\sqrt{5} \operatorname{cis}(1.1071) \quad 21 \quad 5 \operatorname{cis} \frac{\pi}{2}$



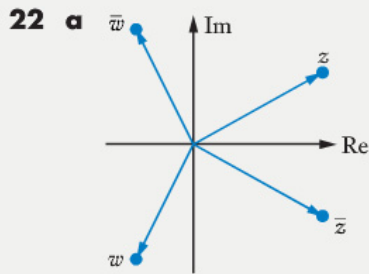

b $\bar{z} = r_1 \text{cis}(-\alpha)$
 $\bar{w} = r_2 \text{cis}(-\beta)$

23 $2 \text{cis}(-30^\circ)$ **24** $7 \text{cis}(-120^\circ)$ **25** $4 \text{cis}(-30^\circ)$

26 $10 \text{cis}(-160^\circ)$ **27** $2 \text{cis}\left(-\frac{\pi}{2}\right)$ **28** $5 \text{cis}\frac{3\pi}{4}$

29 $5 \text{cis}(-0.5)$ **30** $5 \text{cis}\frac{\pi}{2}$

Exercise 2C PAGE 20

1 $16 + 11i$ **2** $-7 + 4i$ **3** $15 \text{cis} 80^\circ$

4 $9 \text{cis}(-90^\circ)$ **5** $9 \text{cis}(-50^\circ)$ **6** $10 \text{cis}\frac{7\pi}{12}$

7 $8 \text{cis}\left(-\frac{\pi}{2}\right)$ **8** $2(\cos 110^\circ + i \sin 110^\circ)$

9 $6(\cos(-40^\circ) + i \sin(-40^\circ))$ **10** $1.2 + 0.6i$

11 $1.2 + 0.6i$ **12** $4 \text{cis} 20^\circ$ **13** $5 \text{cis}(-30^\circ)$

14 $\text{cis} 130^\circ$ **15** $\text{cis}\frac{\pi}{5}$ **16** $2 \text{cis} \pi$

17 $2.5\left(\cos\frac{\pi}{4} + i \sin\frac{\pi}{4}\right)$

18 $0.4(\cos 0 + i \sin 0)$

19 $2 \text{cis} 40^\circ$ **20** $3 \text{cis} 100^\circ$ **21** $2 \text{cis}(-90^\circ)$

22 $2 \text{cis} 120^\circ$ **23** $\text{cis} 160^\circ$ **24** $2 \text{cis}(-140^\circ)$

25 $\text{cis} 120^\circ$ **26** $2 \text{cis} 80^\circ$ **27** $2 \text{cis}(-100^\circ)$

28 a $12 \text{cis} 40^\circ$ **b** $6 \text{cis} 30^\circ$

c $12 \text{cis} 70^\circ$ **d** $12 \text{cis} 70^\circ$

e $6 \text{cis} 130^\circ$ **f** $2 \text{cis} 120^\circ$

g $\frac{1}{3} \text{cis}(-10^\circ)$ **h** $\frac{1}{6} \text{cis}(-40^\circ)$

29 a $32 \text{cis}\left(-\frac{7\pi}{12}\right)$ **b** $32 \text{cis}\left(-\frac{7\pi}{12}\right)$

c $\frac{1}{2} \text{cis}\left(\frac{\pi}{12}\right)$ **d** $2 \text{cis}\left(-\frac{\pi}{12}\right)$

e $8 \text{cis}\left(-\frac{2\pi}{3}\right)$ **f** $4 \text{cis}\left(-\frac{3\pi}{4}\right)$

g $\frac{1}{8} \text{cis}\left(-\frac{2\pi}{3}\right)$ **h** $\frac{1}{4} \text{cis}\left(-\frac{\pi}{4}\right)$

Exercise 2D PAGE 25

1 D

2 A

3 E

4 H

5 K

6 L

7 M

8 P

9

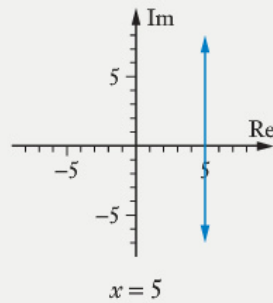

10

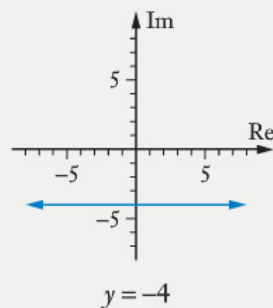

11

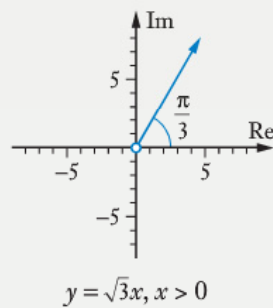

12

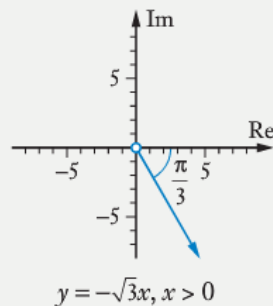

13

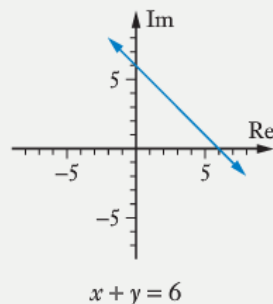

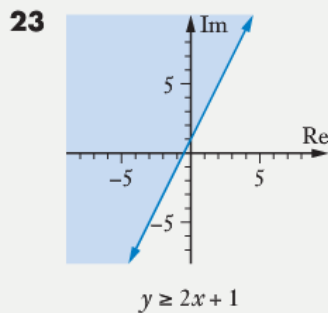
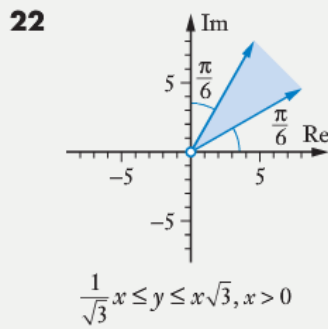
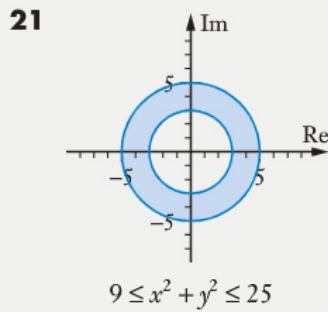
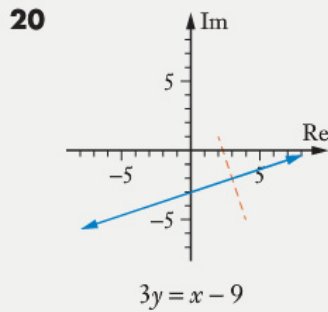
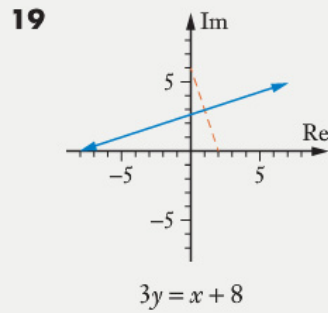
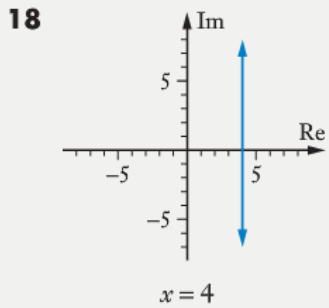
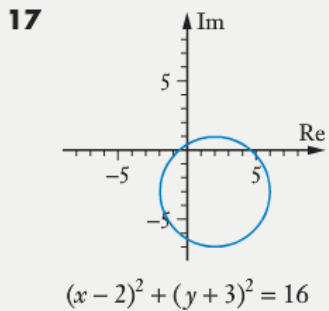
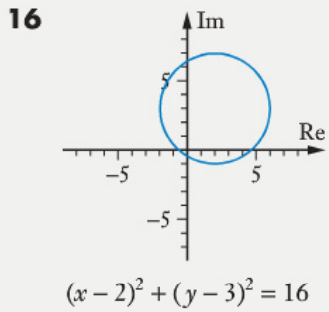
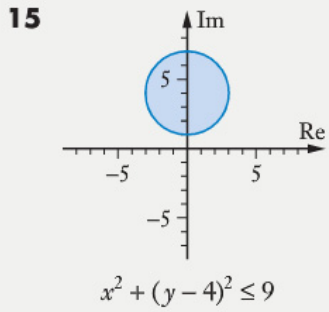
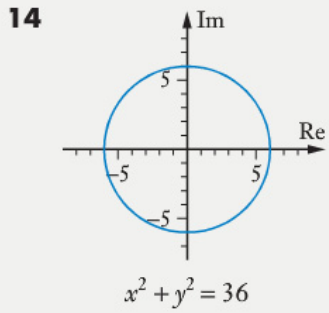

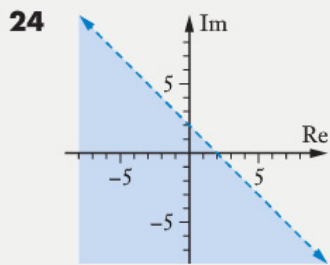

$$y + x < 2$$

(Note the use of the dashed line in question 24 because the question involved $<$ rather than \leq .)

- 25** **a** 1 **b** 5 **c** $3\sqrt{2} - 2$
d $3\sqrt{2} + 2$ **e** $3\sqrt{2} + 2$
- 26** **a** 1 **b** 6 **c** 7
d 3 **e** 0.23 rads **f** 1.06 rads
- 27** Points $z = x + iy$ satisfy the equation $(x - 6)^2 + (y + 5)^2 = 20$, i.e. a circle, centre $(6, -5)$, radius $2\sqrt{5}$.
- 28** Points $z = x + iy$ satisfy the equation $(x - 1)^2 + (y + 4)^2 = 18$, i.e. a circle, centre $(1, -4)$, radius $3\sqrt{2}$.

Exercise 2E PAGE 30

- 1** $1 \operatorname{cis} 0$ (i.e. 1), $1 \operatorname{cis} \left(\frac{\pi}{3}\right)$, $1 \operatorname{cis} \left(\frac{2\pi}{3}\right)$, $1 \operatorname{cis} \pi$, $1 \operatorname{cis} \left(-\frac{\pi}{3}\right)$, $1 \operatorname{cis} \left(-\frac{2\pi}{3}\right)$.
- 2** $1 \operatorname{cis} 0$, $1 \operatorname{cis} 45^\circ$, $1 \operatorname{cis} 90^\circ$, $1 \operatorname{cis} 135^\circ$, $1 \operatorname{cis} 180^\circ$, $1 \operatorname{cis} (-135^\circ)$, $1 \operatorname{cis} (-90^\circ)$, $1 \operatorname{cis} (-45^\circ)$.
- 3** $1 \operatorname{cis} 0$, $1 \operatorname{cis} \left(\frac{2\pi}{7}\right)$, $1 \operatorname{cis} \left(\frac{4\pi}{7}\right)$, $1 \operatorname{cis} \left(\frac{6\pi}{7}\right)$, $1 \operatorname{cis} \left(-\frac{2\pi}{7}\right)$, $1 \operatorname{cis} \left(-\frac{4\pi}{7}\right)$, $1 \operatorname{cis} \left(-\frac{6\pi}{7}\right)$.

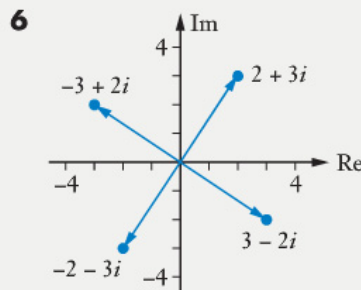
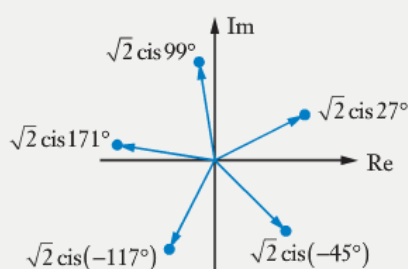
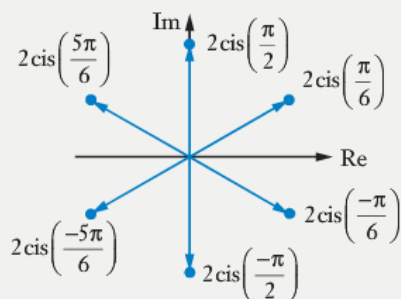

- 7** **a** $3 + 4i$ **b** $-7 + 24i$
c and **d**

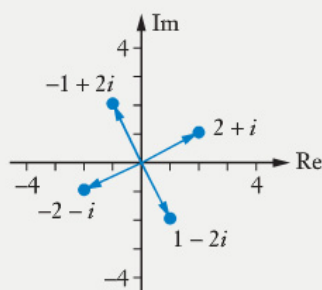

- 8** $k = 32 \operatorname{cis} 100^\circ$. The other solutions are $2 \operatorname{cis} 92^\circ$, $2 \operatorname{cis} 164^\circ$, $2 \operatorname{cis} (-52^\circ)$, $2 \operatorname{cis} (-124^\circ)$
- 9** $-4 + 2i$, $-2 - 4i$, $4 - 2i$

Exercise 2F PAGE 34

- 2** $\cos\left(\frac{2\pi}{3}\right) + i \sin\left(\frac{2\pi}{3}\right)$
- 3** $32 \operatorname{cis}\left(\frac{5\pi}{6}\right)$
- 4** $243 \left(\cos\left(-\frac{\pi}{3}\right) + i \sin\left(-\frac{\pi}{3}\right) \right)$
- 5** $\cos 2\theta = \cos^2 \theta - \sin^2 \theta$, $\sin 2\theta = 2 \sin \theta \cos \theta$
- 6** $\cos 3\theta = \cos^3 \theta - 3 \cos \theta \sin^2 \theta$,
 $\sin 3\theta = 3 \cos^2 \theta \sin \theta - \sin^3 \theta$,
 $\cos 3\theta = 4 \cos^3 \theta - 3 \cos \theta$
- 7** $\cos 5\theta = \cos^5 \theta - 10 \cos^3 \theta \sin^2 \theta + 5 \cos \theta \sin^4 \theta$,
 $\sin 5\theta = 5 \cos^4 \theta \sin \theta - 10 \cos^2 \theta \sin^3 \theta + \sin^5 \theta$
- 8** $8 \operatorname{cis}\left(-\frac{\pi}{2}\right)$ **9** $32 \operatorname{cis}\left(\frac{5\pi}{6}\right)$ **10** $6^4 \operatorname{cis}\left(\frac{2\pi}{3}\right)$
- 11** $2 \operatorname{cis}\left(-\frac{\pi}{9}\right)$, $2 \operatorname{cis}\left(\frac{5\pi}{9}\right)$, $2 \operatorname{cis}\left(-\frac{7\pi}{9}\right)$
- 12** $2 \operatorname{cis}\left(\frac{\pi}{8}\right)$, $2 \operatorname{cis}\left(\frac{5\pi}{8}\right)$, $2 \operatorname{cis}\left(-\frac{7\pi}{8}\right)$, $2 \operatorname{cis}\left(-\frac{3\pi}{8}\right)$
- 13** $2 \operatorname{cis}\left(\frac{3\pi}{16}\right)$, $2 \operatorname{cis}\left(\frac{11\pi}{16}\right)$, $2 \operatorname{cis}\left(-\frac{13\pi}{16}\right)$, $2 \operatorname{cis}\left(-\frac{5\pi}{16}\right)$
- 14** $\sqrt{2} \operatorname{cis}\left(\frac{\pi}{4}\right)$, $\sqrt{2} \operatorname{cis}\left(\frac{3\pi}{4}\right)$, $\sqrt{2} \operatorname{cis}\left(-\frac{3\pi}{4}\right)$, $\sqrt{2} \operatorname{cis}\left(-\frac{\pi}{4}\right)$

15 $z_1 = \sqrt{2} \operatorname{cis}\left(\frac{\pi}{3}\right), z_2 = \sqrt{2} \operatorname{cis}\left(\frac{\pi}{6}\right), \sqrt{2}$

16 a $r \operatorname{cis}(\pi - \theta)$ b $\frac{1}{r} \operatorname{cis}(-\theta)$
 c $\frac{1}{r} \operatorname{cis}(\pi - \theta)$ d $\frac{1}{r^2} \operatorname{cis}(\pi - 2\theta)$

Miscellaneous exercise two PAGE 36

- 1 a $5 - i$ b $1 - 7i$ c $18 + i$
 d $-7 - 24i$ e $-\frac{6}{13} - \frac{17}{13}i$ f $-\frac{6}{25} + \frac{17}{25}i$
- 2 a c b $\frac{1}{4}c$ c $\frac{3}{4}c$
 d $\frac{5}{4}c$ e $a + c$ f $a + \frac{1}{4}c$
 g $a + \frac{1}{2}c$ h $a + \frac{3}{2}c$
- 3 a $6 \operatorname{cis}\left(-\frac{2\pi}{3}\right)$ b $-4\sqrt{3} - 4i$
- 4 a $(0, 2)$ b $(-5, 0)$ c $(-2\sqrt{2}, -2\sqrt{2})$
- 5 $\sqrt{2} \operatorname{cis}\left(\frac{\pi}{4}\right), \sqrt{2} \operatorname{cis}\left(\frac{3\pi}{4}\right), 2 \operatorname{cis} \pi, \operatorname{cis}\left(-\frac{\pi}{2}\right)$
- 7 a $f(-3) = -348, f(3) = 0$
 b $x = 3, x = \frac{3}{4} + \frac{\sqrt{7}}{4}i, x = \frac{3}{4} - \frac{\sqrt{7}}{4}i$

Exercise 3A PAGE 46

- 1 a $\{-1, 1, 3, 5, 7\}$ b $\{-2, 0, 2, 4, 6\}$
 c $\{-9, -5, -1, 3, 7\}$
- 2 a $\{9, 16, 25\}$ b $\{3, 52, 679\}$
 c $\{729, 4096, 15\,625\}$
- 3 a Domain \mathbb{R} Range \mathbb{R}
 b Domain \mathbb{R} Range \mathbb{R}
 c Domain \mathbb{R} Range \mathbb{R}
 d Domain \mathbb{R} Range $\{y \in \mathbb{R}: y = 10\}$
 e Domain \mathbb{R} Range $\{y \in \mathbb{R}: y \geq -25\}$
 f Domain $\{x \in \mathbb{R}: x \neq 5\}$ Range $\{y \in \mathbb{R}: y \neq 1\}$
- 4 a $gf(x)$ b $hf(x)$
 c $fg(x)$ d $fh(x)$
 e $gh(x)$ f $hg(x)$
 g $ff(x)$ h $hh(x)$
 i $fff(x)$

- 5 a $4x - 9$ b $16x + 5$
 c $x^4 + 2x^2 + 2$ d $8x - 1$
 e $8x - 11$ f $2x^2 - 1$
 g $4x^2 - 12x + 10$ h $4x^2 + 5$
 i $16x^2 + 8x + 2$

6 a $4x + 15$ b $9x + 4$ c $\frac{3x + 2}{x + 2}$

d $6x + 7$ e $6x + 16$ f $7 + \frac{4}{x}$

g $\frac{2x + 7}{2x + 5}$ h $4 + \frac{6}{x}$ i $\frac{3(x + 1)}{3x + 1}$

- 7 $\{x \in \mathbb{R}: x \geq 4\}$ 8 $\{x \in \mathbb{R}: x \leq 4\}$
 9 $\{x \in \mathbb{R}: -2 \leq x \leq 2\}$ 10 $\{x \in \mathbb{R}: -4 \leq x \leq 4\}$

- 11 $\{x \in \mathbb{R}: x \geq 2\}$ 12 $\{x \in \mathbb{R}: x \geq 3\}$

- 13 a 12 b 12 c 0.5

d 4 e 0.25

f Domain \mathbb{R} , Range $\{y \in \mathbb{R}: y \geq 3\}$

g Domain $\{x \in \mathbb{R}: x \neq 0\}$, Range $\{y \in \mathbb{R}: y \neq 0\}$

h Domain \mathbb{R} , Range $\{y \in \mathbb{R}: 0 < y \leq \frac{1}{3}\}$

i Domain $\{x \in \mathbb{R}: x \neq 0\}$, Range $\{y \in \mathbb{R}: y > 3\}$

- 14 a 0 b 0 c 2

d 21 e 3

f Domain \mathbb{R} , Range $\{y \in \mathbb{R}: y \leq 25\}$

g Domain $\{x \in \mathbb{R}: x \geq 0\}$, Range $\{y \in \mathbb{R}: y \geq 0\}$

h Domain $\{x \in \mathbb{R}: -5 \leq x \leq 5\}$, Range $\{y \in \mathbb{R}: 0 \leq y \leq 5\}$

i Domain $\{x \in \mathbb{R}: x \geq 0\}$, Range $\{y \in \mathbb{R}: y \leq 25\}$

- 15 a Domain $\{x \in \mathbb{R}: x \neq 1\}$, Range $\{y \in \mathbb{R}: y \neq 0\}$

b Domain $\{x \in \mathbb{R}: x \neq 3\}$, Range $\{y \in \mathbb{R}: y \neq 2\}$

- 16 a Domain $\{x \in \mathbb{R}: x \geq 0\}$, Range $\{y \in \mathbb{R}: y \geq -1\}$

b Domain $\{x \in \mathbb{R}: x \geq 0.5\}$, Range $\{y \in \mathbb{R}: y \geq 0\}$

- 17 a Domain $\{x \in \mathbb{R}: x \neq 0\}$, Range $\{y \in \mathbb{R}: y > 0\}$

b Domain $\{x \in \mathbb{R}: x > 0\}$, Range $\{y \in \mathbb{R}: y > 0\}$

- 20 a Domain $\{x \in \mathbb{R}: x \neq \pm 3\}$,

Range $\{y \in \mathbb{R}: y \leq -\frac{1}{9}\} \cup \{y \in \mathbb{R}: y > 0\}$

where \cup means the two sets are *united* to give the complete range.

- b Domain $\{x \in \mathbb{R}: x \neq 0\}$, Range $\{y \in \mathbb{R}: y > -9\}$

Exercise 3B PAGE 54

- 1 a, b, c, g, h
 2 $x + 2$, Domain \mathbb{R} , Range \mathbb{R}



3 $\frac{x+5}{2}$, Domain \mathbb{R} , Range \mathbb{R}

4 $\frac{x-2}{5}$, Domain \mathbb{R} , Range \mathbb{R}

5 $\frac{1}{x} + 4$, Domain $x \neq 0$, Range $y \neq 4$

6 $\frac{1}{x} - 3$, Domain $x \neq 0$, Range $y \neq -3$

7 $\frac{1+5x}{2x}$, Domain $x \neq 0$, Range $y \neq 2.5$

8 $\frac{1}{x-1} - 2$, Domain $x \neq 1$, Range $y \neq -2$

9 $\frac{1}{3-x} + 1$, Domain $x \neq 3$, Range $y \neq 1$

10 $\frac{1}{x-4} + \frac{1}{2}$, Domain $x \neq 4$, Range $y \neq 0.5$

11 x^2 , Domain $x \geq 0$, Range $y \geq 0$

12 $x^2 - 1$, Domain $x \geq 0$, Range $y \geq -1$

13 $\frac{x^2+3}{2}$, Domain $x \geq 0$, Range $y \geq 1.5$

14 $\frac{x-5}{2}$

15 $\frac{x-1}{3}$

16 $\frac{2}{x-1}$

17 x

18 x

19 $\frac{4}{x-1} + 5$

20 $\frac{x-7}{6}$

21 $\frac{x-7}{6}$

22 $\frac{2x+13}{3}$

23 a A function one-to-one

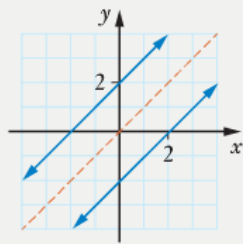

b Not a function

c A function, not one-to-one

d Not a function

e Not a function

f A function, one-to-one

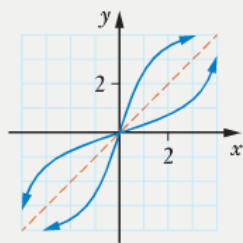

24 For $f(x)$ restricted to $x \geq 0$ then $f^{-1}(x) = \sqrt{x-3}$, domain $x \geq 3$ and range $y \geq 0$.

(Or restrict $f(x)$ to $x \leq 0$ then $f^{-1}(x) = -\sqrt{x-3}$, domain $x \geq 3$ and range $y \leq 0$.)

25 For $f(x)$ restricted to $x \geq -3$ then $f^{-1}(x) = -3 + \sqrt{x}$, domain $x \geq 0$ and range $y \geq -3$

(Or restrict $f(x)$ to $x \leq -3$ then $f^{-1}(x) = -3 - \sqrt{x}$, domain $x \geq 0$ and range $y \leq -3$)

26 For $f(x)$ restricted to $x \geq 3$ then $f^{-1}(x) = 3 + \sqrt{x-2}$, domain $x \geq 2$ and range $y \geq 3$

(Or restrict $f(x)$ to $x \leq 3$ then $f^{-1}(x) = 3 - \sqrt{x-2}$, domain $x \geq 2$ and range $y \leq 3$)

27 For $f(x)$ restricted to $0 \leq x \leq 2$ then $f^{-1}(x) = \sqrt{4-x^2}$, domain $0 \leq x \leq 2$ and range $0 \leq y \leq 2$

(Or restrict $f(x)$ to $-2 \leq x \leq 0$ then $f^{-1}(x) = -\sqrt{4-x^2}$, domain $0 \leq x \leq 2$ and range $-2 \leq y \leq 0$.)

Exercise 3C PAGE 64

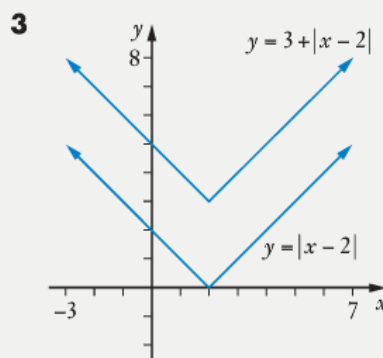
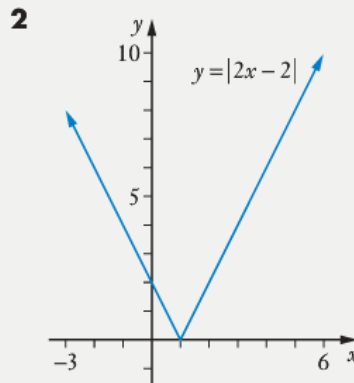
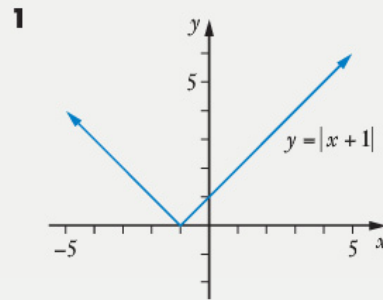

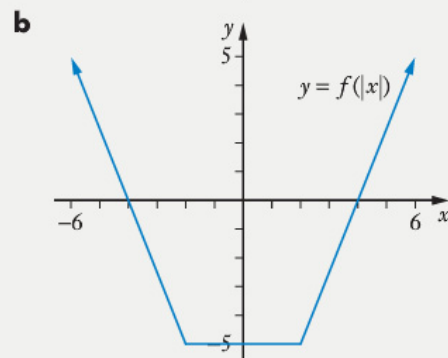
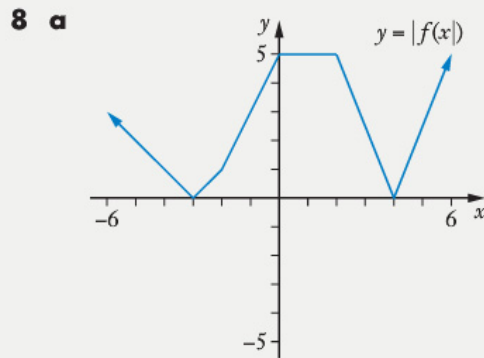
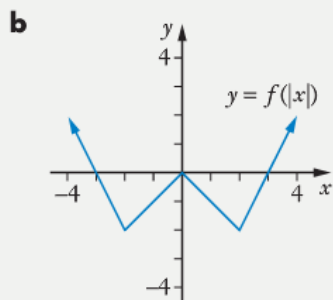
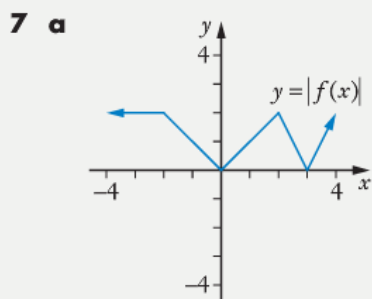
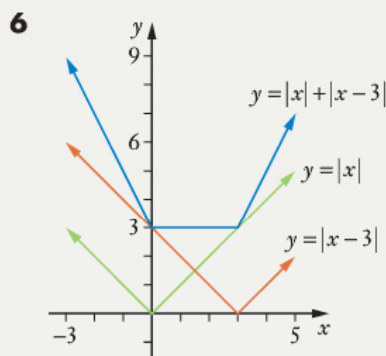
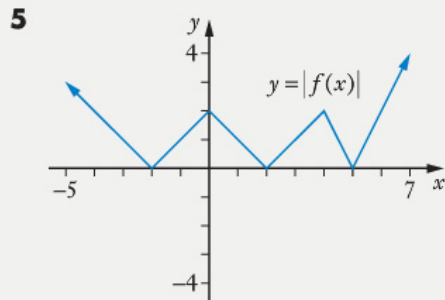
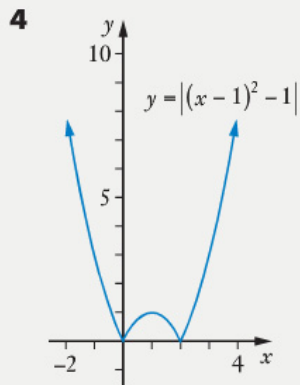

- 9** In the 1st and 4th quadrants (see the diagram below) the graph of $y = g(|x|)$ will be the same as that of $y = g(x)$.

However, in the 2nd and 3rd quadrants the graph of $y = g(|x|)$ will be those parts of $y = g(x)$ that lie in the 1st and 4th quadrants, reflected in the y -axis.

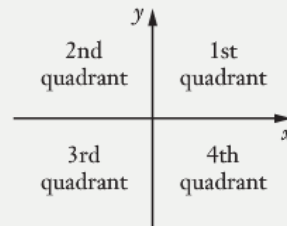

- 10 a** The function $g(x) = (x+1)^2$ has domain \mathbb{R} and range $\{y \in \mathbb{R}: y \geq 0\}$.

The function $f(x) = 2 + \sqrt{x}$ has domain $\{x \in \mathbb{R}: x \geq 0\}$ and range $\{y \in \mathbb{R}: y \geq 2\}$.

Thus $g(x)$ is defined for all real x and the output from $g(x)$ consists of numbers that are all within the domain of $f(x)$. Thus $f[g(x)]$ is defined for all real x .

$$\mathbb{R} \rightarrow \boxed{g(x) = (x+1)^2} \rightarrow y \in \mathbb{R}: y \geq 0$$

$$\rightarrow \boxed{f(x) = 2 + \sqrt{x}} \rightarrow y \in \mathbb{R}: y \geq 2$$

Thus $f[g(x)]$ has domain \mathbb{R} and range $\{y \in \mathbb{R}: y \geq 2\}$.

b $f[g(x)] = 2 + \sqrt{(x+1)^2}$
 $= 2 + |x+1|$

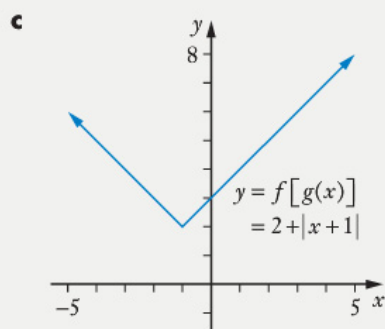

- 11 a** The function $g(x) = (x-2)^2$ has domain \mathbb{R} and range $\{y \in \mathbb{R}: y \geq 0\}$.

The function $f(x) = 1 - \sqrt{x}$ has domain $\{x \in \mathbb{R}: x \geq 0\}$ and range $\{y \in \mathbb{R}: y \leq 1\}$.

Thus $g(x)$ is defined for all real x and the output from $g(x)$ consists of numbers that are all within the domain of $f(x)$. Thus $f[g(x)]$ is defined for all real x .

$$\mathbb{R} \rightarrow \boxed{g(x) = (x-2)^2} \rightarrow y \in \mathbb{R}: y \geq 0$$

$$\rightarrow \boxed{f(x) = 1 - \sqrt{x}} \rightarrow y \in \mathbb{R}: y \leq 1$$

Thus $f[g(x)]$ has domain \mathbb{R} and range $\{y \in \mathbb{R}: y \leq 1\}$.

b $f[g(x)] = 1 - \sqrt{(x-2)^2} = 1 - |x-2|$

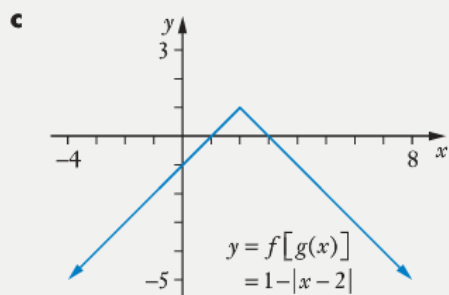

- 12 a** $x = 3, x = 7$ **b** $x = -2, x = 6$
c $x = 4, x = 8$
- 13** Graph not shown here.
a $x = -4, x = 1$ **b** $x = -6, x = 2$
c $x = -4, x = 0$ **d** $x = -3, x = -1$

- 14 a, b and c.**

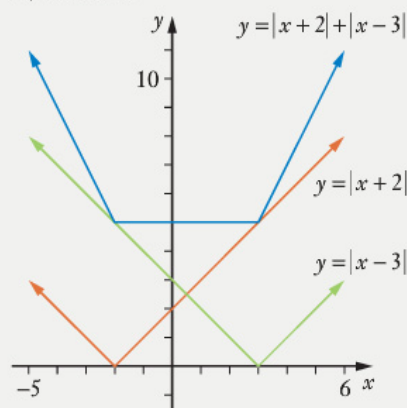

d $-4 \leq x \leq 5$

- 15** $x = -7, x = -5$ **16** No solutions
17 $x = 8$ **18** $x = 3, x = 19$
19 $x = 1$ **20** $x = -5.5, x = 1.5$
21 $-5 \leq x \leq 3$ **22** $x \geq 8$
23 $x \leq -1$ **24** \mathbb{R}
25 $x \leq 3$ **26** \mathbb{R}
27 $>, a = 11, b = -8$ **28** $\leq, a = 7$
29 $<, a = 1$ **30** $a = -0.5, b = 8, c = 3$

Exercise 3D PAGE 75

- 1** $x = 0$ **2** $x = 1$
3 $x = 3$ and $x = 0.5$ **4** $x = 3$
5 Cannot have $y = 0$. **6** Cannot have $y = 2$
7 Cannot have $y = 0$. **8** Cannot have $y = 1$
9 As $x \rightarrow +\infty$, then $y \rightarrow 0^+$
 As $x \rightarrow -\infty$, then $y \rightarrow 0^-$
10 As $x \rightarrow +\infty$, then $y \rightarrow 1^+$
 As $x \rightarrow -\infty$, then $y \rightarrow 1^-$
11 As $x \rightarrow +\infty$, then $y \rightarrow 5^+$
 As $x \rightarrow -\infty$, then $y \rightarrow 5^-$
12 As $x \rightarrow +\infty$, then $y \rightarrow 3^+$
 As $x \rightarrow -\infty$, then $y \rightarrow 3^-$
13 As $x \rightarrow 3^+$, then $y \rightarrow +\infty$
 As $x \rightarrow 3^-$, then $y \rightarrow -\infty$
14 As $x \rightarrow 1^+$, then $y \rightarrow -\infty$
 As $x \rightarrow 1^-$, then $y \rightarrow +\infty$
15 As $x \rightarrow 0^+$, then $y \rightarrow +\infty$
 As $x \rightarrow 0^-$, then $y \rightarrow +\infty$
16 a $y = \frac{1}{(x-3)^2}$ **b** $y = \frac{1}{(x+3)(x-3)}$
c $y = \frac{1}{x-3}$

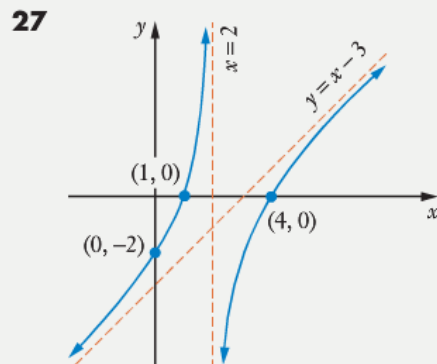
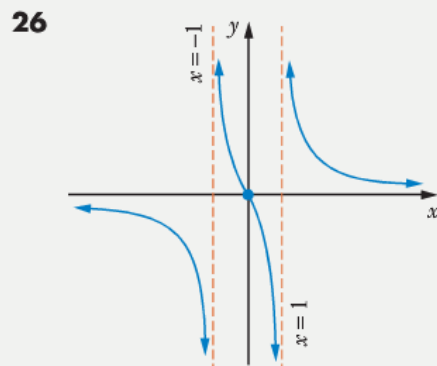
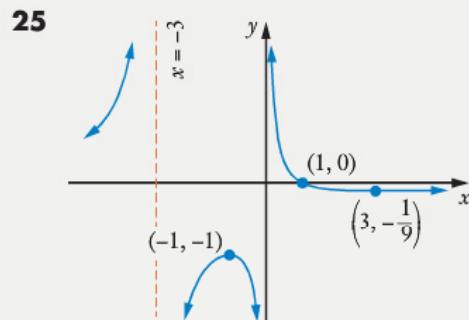
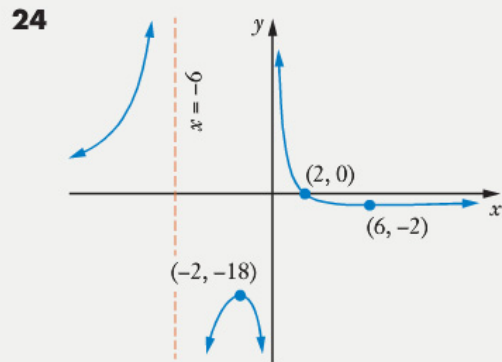
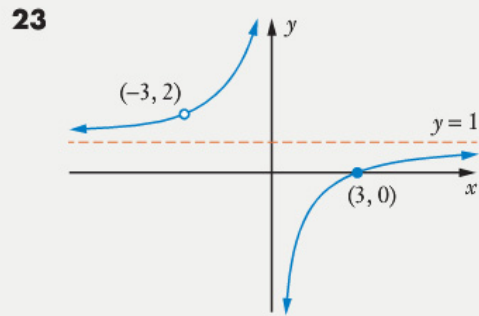
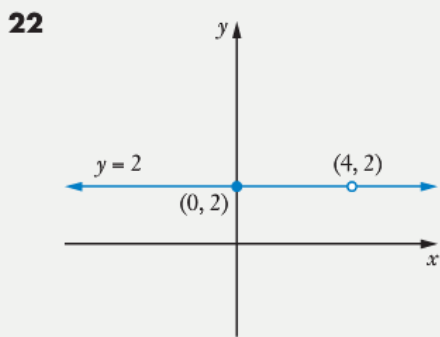
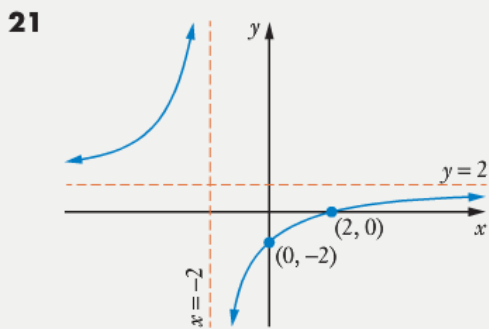
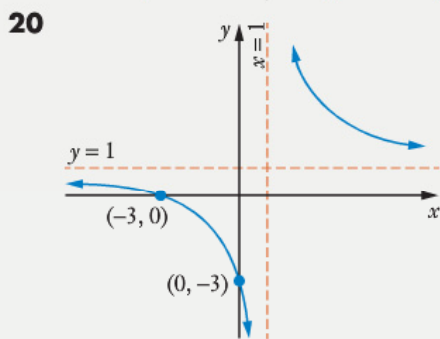
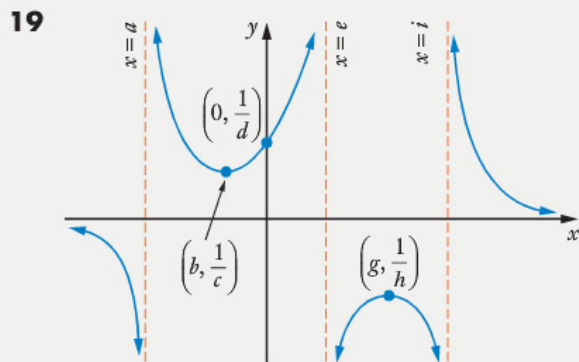
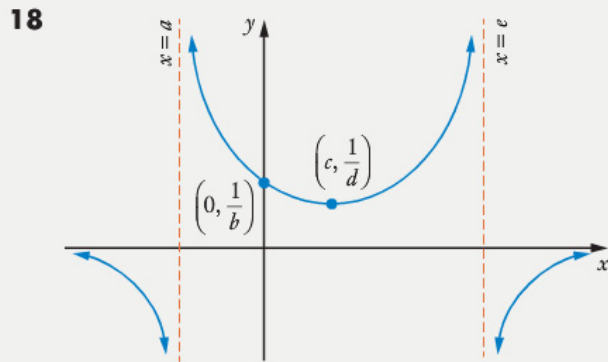

28

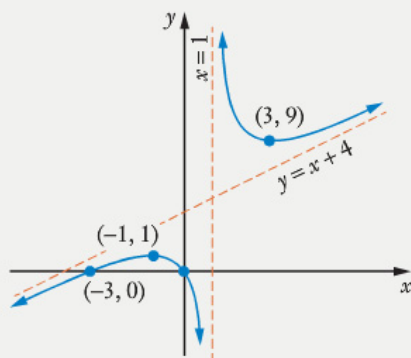

29

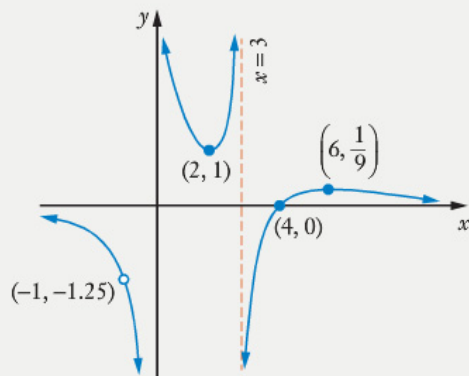

30

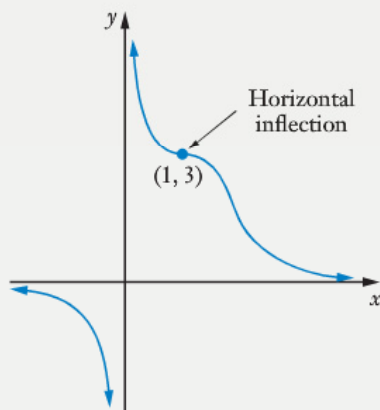

31

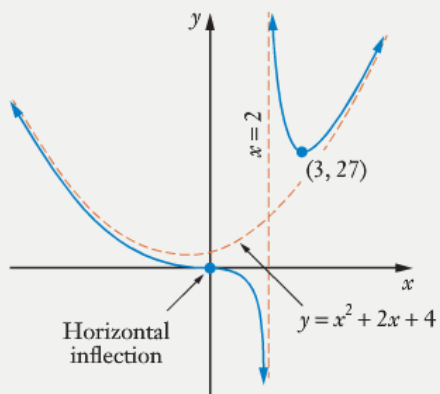

Miscellaneous exercise three PAGE 79

- 1 $x = -1, x = -3 - 2i, x = -3 + 2i$
- 2 $a = -3, b = 1$, C has coordinates $(-1, -0.25)$.
- 3 $x = -f(x)$

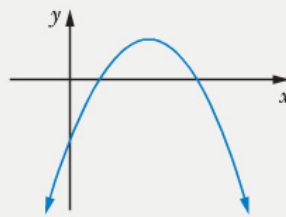

$x = f(-x)$

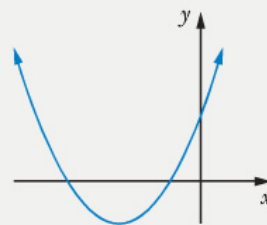

$y = |f(x)|$

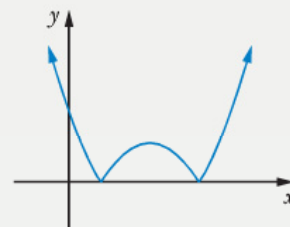

$y = f(|x|)$

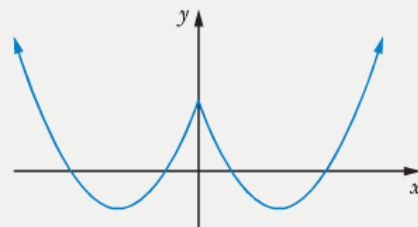

4

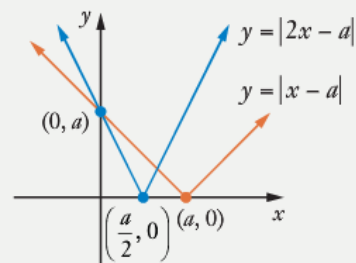

$0 \leq x \leq \frac{2}{3}a$

- 5 a $f(x)$: Domain $2 \leq x \leq 4$, Range $-1 \leq y \leq 3$
 b $f^{-1}(x)$: Domain $-1 \leq x \leq 3$, Range $2 \leq y \leq 4$
 c Sketch of $f(x)$ and $f^{-1}(x)$ shown below.

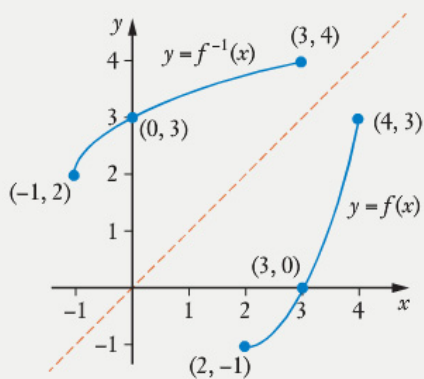

- d $f^{-1}(x) = 2 + \sqrt{x+1}$ for $-1 \leq x \leq 3$
- 6 a $p = q = 0$ b $p = 3, q = 0$
 c $p = -2, q = 1$ d $p = 3, q = -2$
 e $p = 4, q = -1$ f $p = -3, q = 1$
- 7 a $3a - 3b$ b $-3a + 2b$
 c $\frac{3}{2}a - 2b$ d $\frac{1}{2}a - 7b$
- 8 a $1 - \sqrt{3}i$ b $2 \operatorname{cis}\left(-\frac{\pi}{3}\right)$
- 9 $\frac{\sqrt{3}}{8} + i\frac{1}{8}$ 10 $p = iz, q = -z, w = -iz$
- 11 a $2 \operatorname{cis} \frac{5\pi}{12}$ b $2 \operatorname{cis} \frac{\pi}{12}$ c $1 \operatorname{cis} \frac{\pi}{3}$
 d $8 \operatorname{cis} \frac{3\pi}{4}$ e $1 \operatorname{cis}\left(-\frac{\pi}{2}\right)$ f $512 \operatorname{cis} \frac{\pi}{4}$
- 12 $2 \operatorname{cis} \frac{5\pi}{6}, 2^{12} (= 4096)$

Exercise 4A PAGE 86

- 1 $r_A(t) = [(5 + 10t)\mathbf{i} + (4 - t)\mathbf{j}]$ km,
 $r_B(t) = [(6 + 2t)\mathbf{i} + (8t - 8)\mathbf{j}]$ km
 $r_C(t) = [(2 - 4t)\mathbf{i} + (3 + 3t)\mathbf{j}]$ km,
 $r_D(t) = [(19 + 10t)\mathbf{i} + (6t - 4)\mathbf{j}]$ km
 $r_E(t) = [(20 - 4t)\mathbf{i} + (4 + 3t)\mathbf{j}]$ km, $t \geq 1$,
 $r_F(t) = [(12t - 4)\mathbf{i} + (7 - 8t)\mathbf{j}]$ km, $t \geq 0.5$
- 2 a $(10\mathbf{i} + 14\mathbf{j})$ km b $(13\mathbf{i} + 18\mathbf{j})$ km
 c $(19\mathbf{i} + 26\mathbf{j})$ km d 5 km/h
 e $\sqrt{29}$ km
- 3 $(7\mathbf{i} + 24\mathbf{j})$ km a 25 km b 13 km
- 4 a $\sqrt{185}$ km b $\sqrt{65}$ km c $\sqrt{13}$ km
- 5 a 13 km b 17 km

- 6 a $r_A(t) = (28 - 8t)\mathbf{i} + (4t - 5)\mathbf{j}$,
 $r_B(t) = 6t\mathbf{i} + (24 + 2t)\mathbf{j}$
 b At 10 a.m. and again at 10:30 a.m.
- 7 Collision. 1 p.m., $(47\mathbf{i} + 21\mathbf{j})$ km.
 8 No collision.
 9 Collision. 3 p.m., $(3\mathbf{i} + 3\mathbf{j})$ km.
 10 Collision. 2 p.m., $(12\mathbf{i} + 17\mathbf{j})$ km.
 11 No collision.
 12 a Q and R, 10:30 a.m., $(37\mathbf{i} + 5\mathbf{j})$ km
 b 17 km.

Exercise 4B PAGE 92

- 1 $r = (2 + 5\lambda)\mathbf{i} + (3 - \lambda)\mathbf{j}$ 2 $r = (3 + \lambda)\mathbf{i} + (\lambda - 2)\mathbf{j}$
 3 $r = 5\mathbf{i} + (3 - 2\lambda)\mathbf{j}$ 4 $r = 3\lambda\mathbf{i} + (5 - 10\lambda)\mathbf{j}$
 5 $r = \begin{pmatrix} 2 + \lambda \\ -3 + 4\lambda \end{pmatrix}$ 6 $r = \begin{pmatrix} 5\lambda \\ 5 \end{pmatrix}$
- 7 $r = (5\mathbf{i} + 3\mathbf{j}) + \lambda(-3\mathbf{i} - 4\mathbf{j})$
 i.e. $r = (5 - 3\lambda)\mathbf{i} + (3 - 4\lambda)\mathbf{j}$
- 8 $r = (6\mathbf{i} + 7\mathbf{j}) + \lambda(-11\mathbf{i} - 5\mathbf{j})$
 i.e. $r = (6 - 11\lambda)\mathbf{i} + (7 - 5\lambda)\mathbf{j}$
- 9 $r = \begin{pmatrix} -6 \\ 3 \end{pmatrix} + \lambda \begin{pmatrix} 8 \\ 1 \end{pmatrix}$ i.e. $r = \begin{pmatrix} -6 + 8\lambda \\ 3 + \lambda \end{pmatrix}$
- 10 $r = \begin{pmatrix} 1 \\ -3 \end{pmatrix} + \lambda \begin{pmatrix} -4 \\ 4 \end{pmatrix}$ i.e. $r = \begin{pmatrix} 1 - 4\lambda \\ -3 + 4\lambda \end{pmatrix}$
- 11 $r = \begin{pmatrix} 1 \\ 4 \end{pmatrix} + \lambda \begin{pmatrix} 2 \\ -5 \end{pmatrix}$ i.e. $r = \begin{pmatrix} 1 + 2\lambda \\ 4 - 5\lambda \end{pmatrix}$
- 12 $r = \begin{pmatrix} 5 \\ 0 \end{pmatrix} + \lambda \begin{pmatrix} -6 \\ -4 \end{pmatrix}$ i.e. $r = \begin{pmatrix} 5 - 6\lambda \\ -4\lambda \end{pmatrix}$
- 13 a $2\mathbf{i} - 8\mathbf{j}$ b $\sqrt{17}$ units c $2:1$
- 14 a $r = (5 + 7\lambda)\mathbf{i} + (2\lambda - 1)\mathbf{j}$
 b $x = 5 + 7\lambda, y = 2\lambda - 1$
 c $7y = 2x - 17$
- 15 a $r = \begin{pmatrix} 2 - 3\lambda \\ -1 + 4\lambda \end{pmatrix}$ b $x = 2 - 3\lambda, y = -1 + 4\lambda$
 c $4x + 3y = 5$
- 16 a $r = \begin{pmatrix} 7\lambda \\ 3 - 8\lambda \end{pmatrix}$ b $x = 7\lambda, y = 3 - 8\lambda$
 c $8x + 7y = 21$
- 17 a $r = \begin{pmatrix} 2 - 3\lambda \\ -5 + 2\lambda \end{pmatrix}$ b $2x + 3y + 11 = 0$

- 18** **a** $\begin{pmatrix} -1 \\ 3 \end{pmatrix}$ **b** $\begin{pmatrix} 3 \\ -9 \end{pmatrix}$ **c** $3\sqrt{10}$
d 3 : 1 **e** 3 : -1 **f** 3 : 1
- 19** $\mathbf{r} = (7 - 2\lambda)\mathbf{i} + (6\lambda - 2)\mathbf{j}$. B and C lie on the line, D and E do not.
- 20** $\mathbf{r} = \begin{pmatrix} 4 - \lambda \\ -9 + 2\lambda \end{pmatrix}$. H and I lie on the line, G does not.
- 21** $a = -9, b = 21, c = -17, d = -12, e = 11, f = 15$
- 22** $\mathbf{r} = (5 + \lambda)\mathbf{i} - (6 + \lambda)\mathbf{j}$
- 23** $\mathbf{r} = \begin{pmatrix} 6 + 3\lambda \\ 5 - 4\lambda \end{pmatrix}$ **24** $5x + 3y = 46$
- 25** $6\mathbf{i}, 12\mathbf{j}$ **26** $-3\mathbf{i}, -7$
- 27** $\mathbf{r} = (2 + 3\lambda)\mathbf{i} + (3 - 7\lambda)\mathbf{j}, \frac{2}{7}, \frac{37}{3}$
- 28** 8, 19 **29** $7, \frac{4}{3}$
- 30** Set (1). The other two both give the Cartesian equation $2y = x + 4$ but (1) gives $2y = x + 5$.
- 32** $\mathbf{r} = \begin{pmatrix} 4 \\ 3 \end{pmatrix} + \mu \begin{pmatrix} -2 \\ 3 \end{pmatrix}$ **33** 77°

Exercise 4C PAGE 97

- 1** $-\mathbf{i} + 11\mathbf{j}$ **2** $\begin{pmatrix} 2 \\ -1 \end{pmatrix}$ **3** $\begin{pmatrix} -3 \\ 5 \end{pmatrix}$
- 4** Paths of particles do not cross in the *subsequent* motion. (If A was moving with the given velocity prior to $t = 0$ then, when $t = -3$ particle A was at $7\mathbf{i} - 6\mathbf{j}$ and particle B reaches that point when $t = 4$.)
- 5** In the subsequent motion the paths of the particles do meet with both particles reaching the point with position vector $25\mathbf{i} + 10\mathbf{j}$ when $t = 6$. A collision is involved.
- 6** In the subsequent motion the paths of the particles do cross with particle A reaching the point with position vector $15\mathbf{i} + 12\mathbf{j}$ when $t = 7$, particle B being there when $t = 4$. A collision is not involved.

Exercise 4D PAGE 100

- 1** $\mathbf{r} \cdot (3\mathbf{i} + 4\mathbf{j}) = 18$
- 2** $\mathbf{r} \cdot (5\mathbf{i} - \mathbf{j}) = -12$
- 3** Points A, B, E and F lie on the line, C and D do not.
- 4** $u = 2, v = 10, w = 11, x = 8, y = 0, z = -4$
- 5** **a** $\mathbf{r} \cdot (5\mathbf{i} + 2\mathbf{j}) = 7$ **b** $5x + 2y = 7$
- 6** **a** $\mathbf{r} \cdot (2\mathbf{i} + 5\mathbf{j}) = -1$ **b** $2x + 5y = -1$
- 8** $8x + 5y = 7$

Exercise 4E PAGE 105

- 1** **a** $y = 2x - 8$ **b** $y = \frac{1}{x}$
c $y^2 = 4x$ **d** $y = (x^2 + 1)^2, x \geq 0$
- 2** **a** $y = 10 - 2x$ **b** $y = \frac{1}{x+1}$
c $y = x^2 + 2x + 5$ **d** $(x-2)^2 + \left(\frac{y-1}{2}\right)^2 = 1$
- 3** Parametric equations: $\begin{cases} x = 2 \cos \theta \\ y = 3 \sin \theta \end{cases}$
Cartesian equation: $9x^2 + 4y^2 = 36$
- 4** Parametric equations: $\begin{cases} x = -3 \sec \theta \\ y = 2 \tan \theta \end{cases}$
Cartesian equation: $4x^2 - 9y^2 = 36$
- 5** B, D, E.
- 6** **a** $|\mathbf{r}| = 25$
b A lies outside, B lies on, C lies inside, D lies on.
- 7** $x^2 + y^2 = 65^2, a = 39, b = -60$.
- 8** $|\mathbf{r} + 7\mathbf{i} - 4\mathbf{j}| = 4\sqrt{5}$. A lies on.
- 9** **a** $|\mathbf{r} - \mathbf{i} + 5\mathbf{j}| = 9$ **b** $|\mathbf{r} + 3\mathbf{i} - 4\mathbf{j}| = 10$
c $|\mathbf{r} + 12\mathbf{i} - 3\mathbf{j}| = 2\sqrt{3}$ **d** $|\mathbf{r} + 13\mathbf{i} + 2\mathbf{j}| = 4$
- 10** **a** $x^2 + y^2 - 4x - 6y = 12$ **b** $x^2 + y^2 + 8x - 4y = -13$
c $x^2 + y^2 - 8x + 6y = 24$
- 11** **a** $5, 6\mathbf{i} + 3\mathbf{j}$ **b** $6, 2\mathbf{i} - 3\mathbf{j}$ **c** $3, 3\mathbf{i} - 4\mathbf{j}$
d $20, 0\mathbf{i} + 0\mathbf{j}$ **e** $1.25, 0\mathbf{i} + 0\mathbf{j}$ **f** $7, 2\mathbf{i} - 3\mathbf{j}$
g $5, 3\mathbf{i} + 9\mathbf{j}$ **h** $11, -10\mathbf{i} + \mathbf{j}$
- 12** 13
- 13** $\mathbf{r} = (2 + 3\lambda)\mathbf{i} + (-5 + 7\lambda)\mathbf{j}$
- 14** 10. The circles have just one point in common because the distance between the centres equals the sum of the radii.
- 15** $2\sqrt{26}$. The circles have no points in common because the distance between the centres exceeds the sum of the radii.
- 16** $\begin{pmatrix} -3 \\ 12 \end{pmatrix}, \begin{pmatrix} 4 \\ 9 \end{pmatrix}$ **17** $-2\mathbf{i} + 6\mathbf{j}$

Exercise 4F PAGE 109

- 1** $\sqrt{5}$ km at 10:36 a.m. **2** $2\sqrt{5}$ m, 2.25
- 3** Approximately 1.8 metres. The snake probably catches the mouse.
- 4** $5\sqrt{13}$ cm, 5 **5** $3\sqrt{13}$ km
- 6** $\sqrt{17}$ m **7** $3\sqrt{29}$ units
- 8** 5 units **9** $4\sqrt{2}$ units

Miscellaneous exercise four PAGE 111

- 2 a $y = |x + 3|$ b $y = |x - 3|$
 c $y = |3x - 6|$ d $y = |2x + 4|$
 3 a 5, (7, -1) b 6, (7, 1)
 c $3\sqrt{2}$, (0, 0) d $5\sqrt{3}$, (1, -8)
 e 10, (-1, 7) f 15, (-5, 7)

4 a

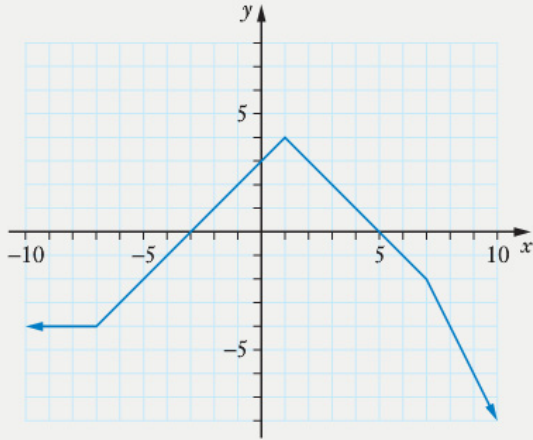

b

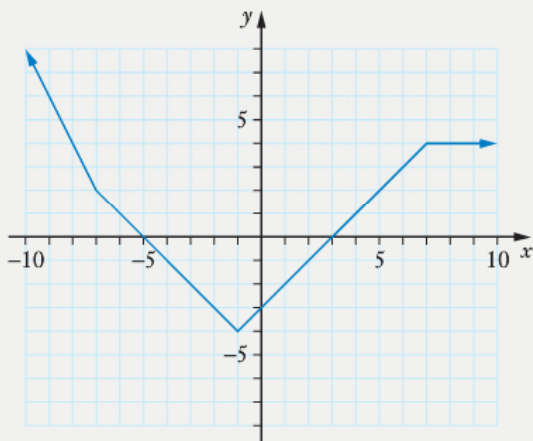

c

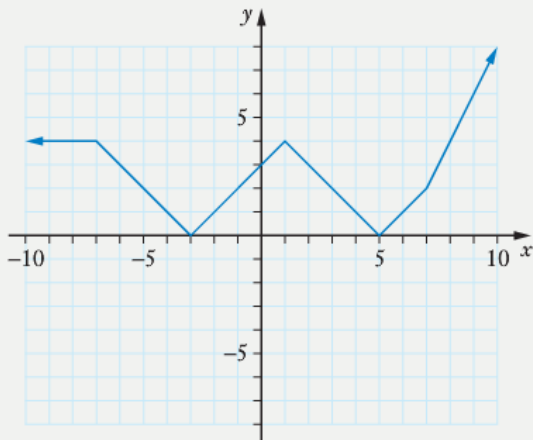

d

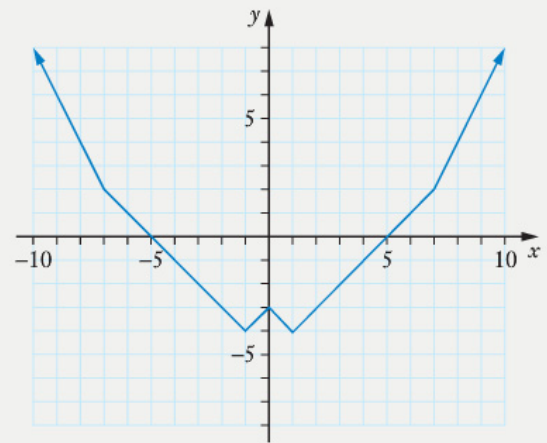

- 5 a $a = 3, b = 5, c = -2$ b $\frac{5}{3}, 1 + 2i, 1 - 2i$
 6 a 0.8 b 0.5
 c $\{x \in \mathbb{R}: x < 4\}$ d $\{y \in \mathbb{R}: y < 1\}$
 e $f^{-1}(x) = 4 - \frac{1}{(1-x)^2}$, domain $\{x \in \mathbb{R}: x < 1\}$,
 range $\{y \in \mathbb{R}: y < 4\}$.
 7 a $\sqrt{3} + i$ b $2 \operatorname{cis}\left(-\frac{2\pi}{3}\right)$
 c $4 \operatorname{cis}\left(-\frac{\pi}{2}\right), -4i$ d $\operatorname{cis}\left(\frac{5\pi}{6}\right), -\frac{\sqrt{3}}{2} + \frac{1}{2}i$
 8 a Line cuts circle in two places,
 position vectors $20\mathbf{i} + 30\mathbf{j}$ and $40\mathbf{i} + 34\mathbf{j}$.
 b Line neither touches not cuts the circle.
 c Line is a tangent to the circle,
 point of contact $-2\mathbf{i} + 4\mathbf{j}$.

Exercise 5A PAGE 120

1 a

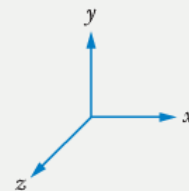

b

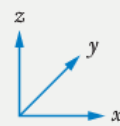

c

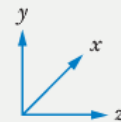

- 2 a $5\mathbf{i} + 14\mathbf{j} + 2\mathbf{k}$ b $-\mathbf{i} - 2\mathbf{j} + 4\mathbf{k}$
 c $7\mathbf{i} + 20\mathbf{j} + 5\mathbf{k}$ d $10\mathbf{i} + 28\mathbf{j} + 4\mathbf{k}$
 e 51 f 51
 g 7 h 15



$$3 \text{ a } \begin{pmatrix} 1 \\ 4 \\ 7 \end{pmatrix} \quad \text{b } \begin{pmatrix} -3 \\ 4 \\ -1 \end{pmatrix} \quad \text{c } \begin{pmatrix} 0 \\ 8 \\ 10 \end{pmatrix} \quad \text{d } \begin{pmatrix} 2 \\ 8 \\ 14 \end{pmatrix}$$

$$\text{e } 10 \quad \text{f } 10 \quad \text{g } \sqrt{26} \quad \text{h } \sqrt{66}$$

$$4 \text{ a } \langle 2, 2, -3 \rangle \quad \text{b } \langle 3, 0, -3 \rangle$$

$$\text{c } \langle 1, 10, -6 \rangle \quad \text{d } \langle 0, 6, -3 \rangle$$

$$\text{e } 7 \quad \text{f } 42$$

$$\text{g } 17 \quad \text{h } \sqrt{17}$$

$$5 \text{ a } \mathbf{i} - \mathbf{j} + 5\mathbf{k} \quad \text{b } -8\mathbf{i} - 3\mathbf{j}$$

$$\text{c } 7\mathbf{i} + 4\mathbf{j} - 5\mathbf{k} \quad \text{d } -7\mathbf{i} - 4\mathbf{j} + 5\mathbf{k}$$

$$6 \text{ a } \begin{pmatrix} 7 \\ 1 \\ 4 \end{pmatrix} \quad \text{b } \begin{pmatrix} 6 \\ -1 \\ 4 \end{pmatrix} \quad \text{c } 57$$

$$7 \text{ a } 7 \quad \text{b } 15 \quad \text{c } 8$$

$$\text{d } 85.6^\circ \text{ (to 1 dp)}$$

$$8 \text{ } 101^\circ \quad 9 \text{ } 80^\circ \quad 10 \text{ } 73^\circ$$

$$11 \text{ a } \frac{1}{7}(2\mathbf{i} - 3\mathbf{j} + 6\mathbf{k}) \quad \text{b } \frac{5}{7}(2\mathbf{i} - 3\mathbf{j} + 6\mathbf{k})$$

$$\text{c } \frac{7}{5}(3\mathbf{i} + 4\mathbf{k}) \quad \text{d } 31^\circ$$

$$12 \text{ a } \text{Parallel} \quad \text{b } \text{Neither}$$

$$\text{c } \text{Neither} \quad \text{d } \text{Perpendicular}$$

$$\text{e } \text{Perpendicular} \quad \text{f } \text{Neither}$$

$$\text{g } \text{Perpendicular}$$

$$13 \text{ } 21 \text{ N}$$

$$14 \text{ } 3\mathbf{i} - 8\mathbf{k}$$

$$15 \text{ a } = \begin{pmatrix} 5 \\ 2 \\ -1 \end{pmatrix}, \text{ b } = \begin{pmatrix} 2 \\ -1 \\ 3 \end{pmatrix}$$

$$16 \text{ } p = 2, q = -4, r = 6$$

$$17 \text{ a } -2\mathbf{i} + 9\mathbf{k} \quad \text{b } 4\mathbf{j} + 7\mathbf{k} \quad \text{c } \sqrt{93} \text{ m} \quad \text{d } 4.5$$

$$19 \text{ } \begin{pmatrix} 1 \\ 6 \\ 2 \end{pmatrix}$$

$$20 \text{ } 5\mathbf{i} - 4\mathbf{j} + 3\mathbf{k}$$

$$21 \text{ } 8\mathbf{i} + 4\mathbf{j} - 6\mathbf{k}$$

$$23 \text{ To 1 dp: } 57.7^\circ, 36.7^\circ, 74.5^\circ$$

$$24 \text{ d } = \mathbf{a} - \mathbf{b} + 2\mathbf{c}, \text{ e } = \mathbf{a} - 2\mathbf{b} + \mathbf{c}, \text{ f } = -2\mathbf{a} - \mathbf{b} + \mathbf{c}$$

$$25 \text{ a } \overrightarrow{DC} = 10\mathbf{i}, \overrightarrow{DB} = 10\mathbf{i} + 4\mathbf{k}, \overrightarrow{DI} = 3\mathbf{j} + \mathbf{k}$$

$$\text{b } 83^\circ$$

$$26 \text{ To 1 dp: } \quad \text{a } 60.8^\circ \quad \text{b } 73.0^\circ$$

$$27 \text{ a } \overrightarrow{AB} = \begin{pmatrix} 6 \\ 2 \\ 1 \end{pmatrix}, \overrightarrow{BC} = \begin{pmatrix} -1 \\ -2 \\ 3 \end{pmatrix}, \overrightarrow{AC} = \begin{pmatrix} 5 \\ 0 \\ 4 \end{pmatrix}$$

$$\text{c } 41$$

$$\text{d } \text{To nearest degree: } \angle A = 34^\circ, \angle B = \angle C = 73^\circ$$

Exercise 5B PAGE 126

$$2 \text{ a } \times \mathbf{b} = 6\mathbf{i} - \mathbf{j} + 9\mathbf{k} \quad 3 \text{ c } \times \mathbf{d} = -\mathbf{i} - 4\mathbf{j} + 5\mathbf{k}$$

$$4 \text{ p } \times \mathbf{q} = 6\mathbf{j} + 9\mathbf{k} \quad 5 \text{ i } \times \mathbf{j} = \mathbf{k}$$

$$6 \text{ a } \mathbf{a} \times \mathbf{b} = 2\mathbf{j} + 4\mathbf{k}, |\mathbf{a} \times \mathbf{b}| = 2\sqrt{5}$$

$$\text{b } |\mathbf{a} \times \mathbf{b}| = 2\sqrt{5}$$

$$7 \text{ } \frac{1}{\sqrt{3}}(\mathbf{i} + \mathbf{j} + \mathbf{k}) \text{ [or } -\frac{1}{\sqrt{3}}(\mathbf{i} + \mathbf{j} + \mathbf{k})]$$

$$8 \text{ } \frac{1}{\sqrt{17}}(2\mathbf{i} + 2\mathbf{j} + 3\mathbf{k}) \text{ [or } -\frac{1}{\sqrt{17}}(2\mathbf{i} + 2\mathbf{j} + 3\mathbf{k})]$$

Exercise 5C PAGE 134

$$1 \text{ a } \mathbf{r} = 3\mathbf{i} + 2\mathbf{j} - \mathbf{k} + \lambda(2\mathbf{i} - \mathbf{j} + 2\mathbf{k})$$

$$\text{b } x = 3 + 2\lambda, y = 2 - \lambda, z = -1 + 2\lambda$$

$$2 \text{ a } \mathbf{r} = 4\mathbf{i} + 2\mathbf{j} + 3\mathbf{k} + \lambda(\mathbf{i} + \mathbf{j} + 2\mathbf{k})$$

$$\text{b } x = 4 + \lambda, y = 2 + \lambda, z = 3 + 2\lambda$$

$$3 \text{ r} \cdot (3\mathbf{i} - \mathbf{j} + 5\mathbf{k}) = 19$$

$$4 \text{ r} \cdot \begin{pmatrix} 5 \\ 1 \\ 3 \end{pmatrix} = 2$$

$$5 \text{ r } = 2\mathbf{i} + 3\mathbf{j} - 2\mathbf{k} + \lambda(2\mathbf{i} + \mathbf{j}) + \mu(3\mathbf{i} - 4\mathbf{j} + 6\mathbf{k})$$

$$6 \text{ r } = \begin{pmatrix} -3 \\ 2 \\ -1 \end{pmatrix} + \lambda \begin{pmatrix} 2 \\ 0 \\ -3 \end{pmatrix} + \mu \begin{pmatrix} 1 \\ -3 \\ 2 \end{pmatrix}$$

$$7 \text{ } a = -7, b = 4$$

$$8 \text{ } 3x + 2y - z = 21$$

$$9 \text{ r} \cdot (2\mathbf{i} - 3\mathbf{j} + 7\mathbf{k}) = 5$$

$$11 \text{ Point of intersection has position vector } \begin{pmatrix} -2 \\ 2 \\ 4 \end{pmatrix}.$$

$$12 \text{ Point of intersection has position vector } -4\mathbf{i} + 13\mathbf{j} + 13\mathbf{k}.$$

$$13 \text{ b } 3\mathbf{i} + 6\mathbf{j} - 7\mathbf{k}, 90^\circ$$

$$15 \text{ Collision occurs when } t = 7, \text{ at point with position}$$

$$\text{vector } \begin{pmatrix} 25 \\ -50 \\ 30 \end{pmatrix}.$$

16 Can be written in many ways.

$$\text{One possibility is } \mathbf{r} = \begin{pmatrix} 1 \\ 2 \\ 0 \end{pmatrix} + \lambda \begin{pmatrix} 1 \\ 0 \\ 1 \end{pmatrix} + \mu \begin{pmatrix} 1 \\ -3 \\ -5 \end{pmatrix}.$$

Cartesian equation: $x + 2y - z = 5$

Scalar product form: $\mathbf{r} \cdot \begin{pmatrix} 1 \\ 2 \\ -1 \end{pmatrix} = 5$

17 $9\mathbf{i} - 8\mathbf{j} + 15\mathbf{k}$

18 3.25

19 $(720\mathbf{i} + 600\mathbf{j} - 6\mathbf{k})$ km/h

20 **b** The planes are 9 units apart.

21 Minimum separation distance is 7 metres and it occurs when $t = 10$.

Exercise 5D PAGE 138

1 Centre $(0, 0, 0)$, radius 16

2 Centre $(0, 0, 0)$, radius 10

3 Centre $(1, 1, 1)$, radius 25

4 Centre $(2, -3, 4)$, radius 18

5 Centre $(3, -1, 2)$, radius $\sqrt{10}$

6 Centre $(-4, 1, 0)$, radius 5

7 Centre $(0, 4, 0)$, radius $5\sqrt{2}$

8 Centre $(1, -3, 0)$, radius 5

9 Centre $(0, 3, -1)$, radius 11

10 Centre $(-4, 1, -1)$, radius 5

11 Outside 12 On

13 Outside 14 Inside

15 Outside 16 On

17 Inside 18 On

19 $a = 4, b = 6, c = 4$ 20 $\begin{pmatrix} 2 \\ 6 \\ 3 \end{pmatrix}$ and $\begin{pmatrix} 6 \\ -4 \\ 7 \end{pmatrix}$

21 $10\mathbf{i} - \mathbf{j}$ and $6\mathbf{i} - 2\mathbf{j} + 9\mathbf{k}$

22 $7\mathbf{i} - \mathbf{j} + \mathbf{k}$ 23 $\begin{pmatrix} 4 \\ -2 \\ 5 \end{pmatrix}$

Exercise 5E PAGE 141

1 $\frac{2\sqrt{42}}{7}$ 2 $\frac{\sqrt{195}}{15}$ 3 $\frac{3\sqrt{26}}{26}$

Miscellaneous exercise five PAGE 142

1 **a** $f(3) = 7$ **b** $f(-3) = -11$ **c** $g(3) = 7$

d $g(-3) = 7$ **e** $f(5) = 13$ **f** $g(-5) = 13$

g Graph of $y = f(x)$, i.e. $y = 3x - 2$

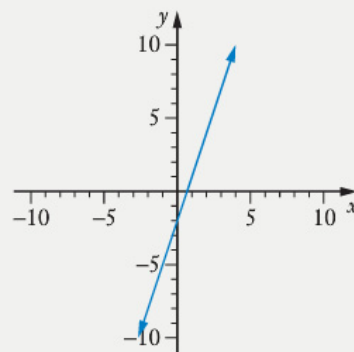

Graph of $y = f(|x|)$, i.e. $y = 3|x| - 2$

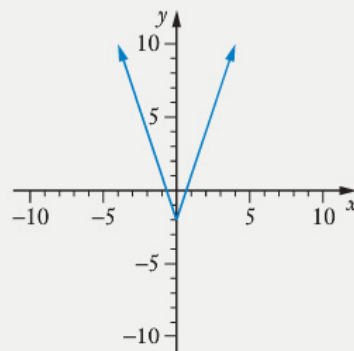

2 **a** P has coordinates $(5, -1)$.

b The circle has a radius of 5 units.

c The vector equation of the circle is $|\mathbf{r} - (5\mathbf{i} - \mathbf{j})| = 5$

3 **a** $7, (3, -2)$

b $11, (2, 7)$

c $4, (3, -2)$

d $2\sqrt{5}, (-1, -7)$

e $5, (4, 2)$

f $10, (-3, 7)$

4 75°

5 **a** $\{y \in \mathbb{R}: y \geq 0\}$

b $\{y \in \mathbb{R}: y \geq 3\}$

c $\{y \in \mathbb{R}: y \geq 0\}$

d $\{y \in \mathbb{R}: y \geq 0\}$

e $\{y \in \mathbb{R}: y \geq 3\}$

f $\{y \in \mathbb{R}: y \geq 0\}$

6 $a < 26$

7 $f \circ g(x) = \frac{3}{2x-1}$, Domain $\{x \in \mathbb{R}: x \neq 0.5\}$,

Range $\{y \in \mathbb{R}: y \neq 0\}$

$g \circ f(x) = \frac{6}{x} - 1$, Domain $\{x \in \mathbb{R}: x \neq 0\}$,

Range $\{y \in \mathbb{R}: y \neq -1\}$

8 $f \circ g(x) = \sqrt{x^2 + 4}$, Domain \mathbb{R} , Range $\{y \in \mathbb{R}: y \geq 2\}$

$g \circ f(x) = x + 4$, Domain $\{x \in \mathbb{R}: x \geq -3\}$,

Range $\{y \in \mathbb{R}: y \geq 1\}$

9 a $8 \operatorname{cis}\left(-\frac{\pi}{6}\right)$ b $8\sqrt{3} \operatorname{cis} 0$ c $8 \operatorname{cis}\left(\frac{\pi}{2}\right)$

d $64 \operatorname{cis} 0$ e $1 \operatorname{cis}\left(\frac{\pi}{3}\right)$

10 a 1 b 7 c $4\sqrt{2} - 3$
d $4\sqrt{2} + 3$ e $4\sqrt{2} + 3$

11 a $6 \operatorname{cis}\left(\frac{5\pi}{6}\right)$ b $6 \operatorname{cis}\left(-\frac{2\pi}{3}\right)$ c $6 \operatorname{cis}\left(\frac{\pi}{6}\right)$

d $1.5 \operatorname{cis}\left(\frac{\pi}{2}\right)$ e $3 \operatorname{cis}\left(-\frac{2\pi}{3}\right)$ f $2 \operatorname{cis}\left(\frac{\pi}{3}\right)$

g $3 \operatorname{cis}\left(-\frac{5\pi}{6}\right)$ h $6 \operatorname{cis}\left(-\frac{\pi}{6}\right)$ i $6 \operatorname{cis}\left(-\frac{\pi}{6}\right)$

j $72 \operatorname{cis}\left(-\frac{\pi}{3}\right)$

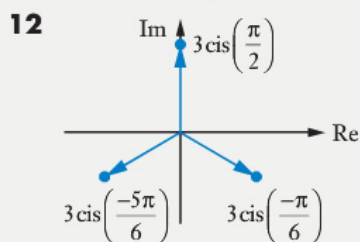

13 $\frac{5^4}{2^4} \operatorname{cis}\left(\frac{2\pi}{3}\right)$, $\frac{3^4}{2^4} \operatorname{cis}\left(\frac{2\pi}{3}\right)$

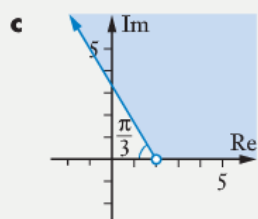
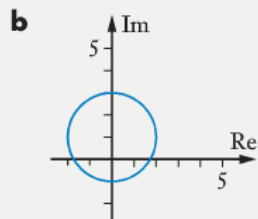
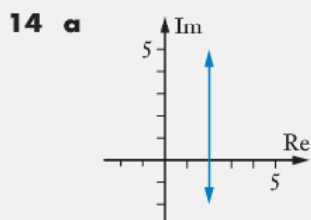

15 $9j + k$

- 16 a The lines are parallel. b The lines are skew.
c The lines intersect. d The lines are parallel.

17 13, 52 m

19 $-56 \text{ m}, (-192i + 216j + 16k) \text{ m/s}$

Exercise 6A PAGE 155

1 $x = 3, y = -2, z = 5$

2 $x = 4, y = 7, z = -2$

3 $x = -1, y = 5, z = 1$

4 $x = 1, y = 4, z = -3$

5 $x = 3, y = 4, z = 6$

6 $x = 1, y = -2, z = -3$

7 $\begin{bmatrix} 3 & 2 & 10 \\ 1 & -4 & 8 \end{bmatrix}$

8 $\begin{bmatrix} -1 & 5 & 12 \\ 2 & 3 & 2 \end{bmatrix}$

9 $\begin{bmatrix} 1 & 4 & 3 & 18 \\ 3 & 1 & 2 & 11 \\ 5 & 2 & 1 & 12 \end{bmatrix}$

10 $\begin{bmatrix} 2 & 0 & 3 & 14 \\ 4 & 1 & -1 & 0 \\ 2 & 1 & 6 & 26 \end{bmatrix}$

11 $\begin{bmatrix} 3 & 2 & 0 & 8 \\ 1 & 0 & 2 & 8 \\ 0 & 2 & -1 & -1 \end{bmatrix}$

12 $\begin{bmatrix} 1 & 3 & -5 & 2 \\ 2 & 1 & 7 & 37 \\ -1 & 0 & 1 & 3 \end{bmatrix}$

13 $x = 7, y = 9$

14 $x = 5, y = -2$

15 $x = 3, y = 1, z = 2$

16 $x = 4, y = 3, z = -1$

17 $x = 7, y = 0, z = -2$

18 $x = 3, y = -1, z = -2$

19 $x = 5, y = 1, z = -8$

20 $x = 3, y = 1, z = 3$

21 $x = 2, y = -3, z = 4$

22 $x = 3, y = 1, z = -2$

23 $x = -5, y = 11, z = 0$

24 $w = 1, x = -3, y = 2, z = 1$

25 $5x + 3y = 270, x + 2y = 110, x = 30, y = 40$

26 $5p + 10q + 4r = 160, 2p + q + 4r = 94, p + 2q + 2r = 56$
4 P tablets, 6 Q tablets and 20 R tablets.

27 a $5x + 3y + 8z = 6100, x + 5y + z = 1800,$
 $4x + 2y + z = 2100$

b $x = 300, y = 200, z = 500$

Exercise 6B PAGE 165

1 0 2 2 3 -0.5

4 -3 5 1.5 6 $k \neq 2$

7 2 8 -1 9 3

10 -5 11 3 12 6

13 0 14 -0.5 15 -2

16 0 17 0

18 Infinite solutions for all values of k . Thus k can take any value.

19 -1 20 3

21 a $p = 1.5, q = 10$ b $p = 1.5, q \neq 10$

c $p \neq 1.5$, no restriction on q .

22 a $p = 6, q = 9$ b $p = 6, q \neq 9$

c $p \neq 6$, no restriction on q .

- 23** $p = 9, q = 1$ **24** $p = -1, q = 5$
25 $p \neq -1$ **26** $p \neq 5$
27 Infinite solutions
28 a $k \neq 0.5$, no restriction on m
b $k = 0.5, m \neq -1$ **c** $k = 0.5, m = -1$
29 a no solution **b** infinite solutions
c unique solution: $x = 3, y = -1, z = 4$
30 a $k \neq 2$, no restriction on m
b $k = 2, m \neq -\frac{4}{3}$ **c** $k = 2, m = -\frac{4}{3}$

Miscellaneous exercise six PAGE 167

- 2 a** $-8 < a < 2$ **b** -8 or 2
3 a $P_1(0, a), P_2(0, b)$ **b** $a > b$
c $P_4(a, 0), P_6(2b, 0)$
d $P_3(2a - 2b, 2b - a), P_5\left(\frac{2a + 2b}{3}, \frac{2b - a}{3}\right)$
e A, E, G **f** C
g B, F **h** D

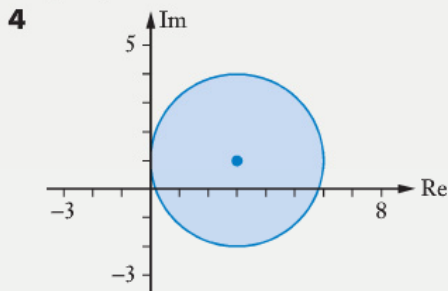

- 5 a** $10 \operatorname{cis} \frac{-5\pi}{6}$ **b** $-3\sqrt{2} + 3\sqrt{2}i$
7 a $z = \sqrt{2} \operatorname{cis}\left(-\frac{\pi}{4}\right)$ **b** $128i$

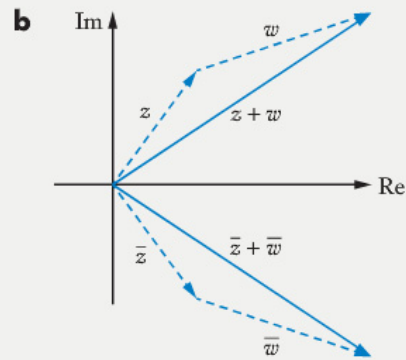
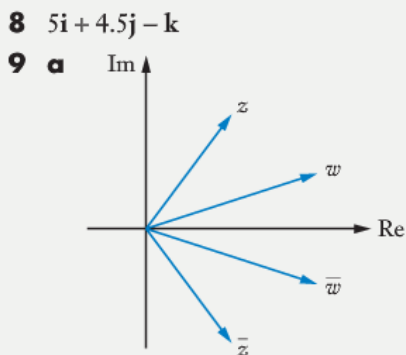

$\overline{z + w}$ is the reflection of $(z + w)$ in the real axis.

But, from the diagram, $\overline{z} + \overline{w}$ is a reflection of $(z + w)$ in the real axis.

Hence $\overline{z + w} = \overline{z} + \overline{w}$.

- c** Justification not shown here. Compare your answer to those of others in your class.
10 $16 \operatorname{cis} 160^\circ, 2 \operatorname{cis} 130^\circ, 2 \operatorname{cis} (-50^\circ), 2 \operatorname{cis} (-140^\circ)$
11 a Domain $\{x \in \mathbb{R}: x > 3\}$, Range $\{y \in \mathbb{R}: y > 4\}$.
b $f^{-1}(x) = \frac{1}{(x - 4)^2} + 3$, Domain $\{x \in \mathbb{R}: x > 4\}$,
 Range $\{y \in \mathbb{R}: y > 3\}$.
12 $\cos 4\theta = \cos^4 \theta - 6\cos^2 \theta \sin^2 \theta + \sin^4 \theta$,
 $\sin 4\theta = 4\cos^3 \theta \sin \theta - 4\cos \theta \sin^3 \theta$
13 The planes are 8 units apart.
14 The shortest distance from the line to the origin
 is $\frac{\sqrt{26}}{2}$ units.
15 10

Exercise 7A PAGE 175

- 1 a** j m **b** $(54i + 3j)$ m/s
c $15\sqrt{13}$ m/s **d** $36i$ m/s²
2 a 10 m/s **b** 12 m
3 a $\sqrt{5}$ **b** $\frac{5t - 1}{\sqrt{5t^2 - 2t + 1}}$
4 a $-0.25i + 2j$ **b** 0.25i
c $2.5i + 5j$
5 a 7 **b** 2.5
6 a $2i + ej$ **b** $0.1ej$
c $20i + 10ej$
7 a 15 m **b** $(8i + 6j)$ m/s
c 10 m/s **d** 37°
8 a $4\sqrt{13}$ m/s **b** $(18i + 4j)$ m/s²
c 176 **d** 15.3°

- 9 a $\sqrt{10}$ m/s b $\sqrt{146}$ m/s
 c $(2\mathbf{i} + 12\mathbf{j})$ m/s² d $(17\mathbf{i} + 124\mathbf{j} - 9\mathbf{k})$ m
- 10 a 8 b 3 c 1.5
- 11 $(3\mathbf{i} + 4\mathbf{j} + 6\mathbf{k})$ m, $2\mathbf{j}$ m/s, $2\mathbf{k}$ m/s²
- 12 a $[2\mathbf{i} + (2t - 8)\mathbf{j}]$ m/s
 b $[(2t + 1)\mathbf{i} + (t^2 - 8t + 20)\mathbf{j}]$ m
 c $\sqrt{74}$ m
 d $2\sqrt{5}$ m/s
 e 4, 4 m
 f $4y = x^2 - 18x + 97$
- 13 a 2
 b Does not cross the y -axis.
- 14 $[-2\pi\mathbf{i} + \pi^2\mathbf{j} + (e^\pi - \pi - 1)\mathbf{k}]$ m
- 15 a $\frac{\pi}{6}$
 b $(6\cos 3t\mathbf{i} - 6\sin 3t\mathbf{j})$ m/s, $(-18\sin 3t\mathbf{i} - 18\cos 3t\mathbf{j})$ m/s²
- 16 8 m

Exercise 7B PAGE 179

- 1 velocity = $(u + at)\mathbf{i}$ m/s,
 position vector = $\left(ut + \frac{1}{2}at^2\right)\mathbf{i}$ m
- 2 $[14t\mathbf{i} + (35t - 4.9t^2)\mathbf{j}]$ m, 87.5 m, $y = \frac{5}{2}x - \frac{1}{40}x^2$
- 3 a $-10\mathbf{j}$ m/s²
 b $(40\mathbf{i} + 40\sqrt{3}\mathbf{j})$ m/s
 c $[40t\mathbf{i} + (40\sqrt{3}t - 5t^2)\mathbf{j}]$ m
 d $8\sqrt{3}$ s
 e $320\sqrt{3}$ m
- 4 a $[42t\cos\theta\mathbf{i} + (42t\sin\theta - 4.9t^2)\mathbf{j}]$ m
 b $20.9^\circ, 69.1^\circ$
- 5 a $[u\cos\theta^\circ\mathbf{i} + (u\sin\theta^\circ - gt)\mathbf{j}]$ m/s
 b $\left[ut\cos\theta^\circ\mathbf{i} + \left(ut\sin\theta^\circ - \frac{1}{2}gt^2\right)\mathbf{j}\right]$ m
 c $\frac{2u\sin\theta^\circ}{g}$ seconds
 d $\frac{u^2\sin 2\theta^\circ}{g}$ metres
 e 45
- 6 a $\mathbf{v}(t) = -\sin(0.5t)\mathbf{i} + \cos(0.5t)\mathbf{j}$,
 $\mathbf{a}(t) = -0.5\cos(0.5t)\mathbf{i} - 0.5\sin(0.5t)\mathbf{j}$
 b 1
 c 0, velocity always perpendicular to acceleration.
 d 0.25

e With $k > 0$, the acceleration is always directed towards $(0, 0)$, the centre of the circle.

7 a $-5\sin\left(\frac{\pi}{2}t\right)\mathbf{i} + 5\cos\left(\frac{\pi}{2}t\right)\mathbf{j}$

b $5\mathbf{i}$

c

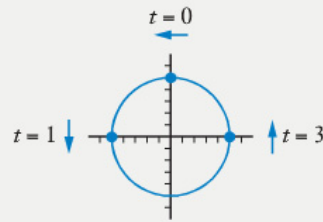

d $(5\mathbf{i} - 5\mathbf{j})$ m. This is the vector from $\mathbf{r}(0)$ to $\mathbf{r}(3)$.

It is the displacement vector for $t = 0$ to $t = 3$.

$5\sqrt{2}$ m.

This is the magnitude of the displacement from $t = 0$ to $t = 3$.

$\frac{15\pi}{2}$.

This is the distance travelled from $t = 0$ to $t = 3$,

i.e. three quarters of the circumference.

8 a

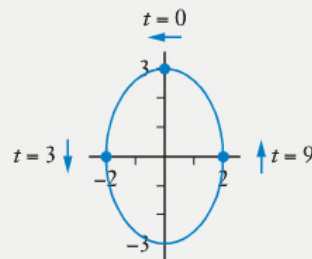

b $9x^2 + 4y^2 = 36$

c 1.20 rads

d Acceleration is always towards $(0, 0)$. $k = \frac{\pi^2}{36}$

9 $\frac{49}{20}t(10\sqrt{3} - t)\mathbf{i} + \frac{49}{20}t(10 - \sqrt{3}t)\mathbf{j}$

10 a $(t - \sin t)\mathbf{i} + (1 - \cos t)\mathbf{j}$

b 2 m

c i $\mathbf{r} = 0\mathbf{i} + 0\mathbf{j}$, $\mathbf{v} = 0\mathbf{i} + 0\mathbf{j}$

ii $\mathbf{r} = (0.5\pi - 1)\mathbf{i} + \mathbf{j}$, $\mathbf{v} = \mathbf{i} + \mathbf{j}$

iii $\mathbf{r} = \pi\mathbf{i} + 2\mathbf{j}$, $\mathbf{v} = 2\mathbf{i} + 0\mathbf{j}$

iv $\mathbf{r} = (1.5\pi + 1)\mathbf{i} + \mathbf{j}$, $\mathbf{v} = \mathbf{i} - \mathbf{j}$

Miscellaneous exercise seven PAGE 182

1 $2\operatorname{cis}\frac{5\pi}{6}$

2 $-3\sqrt{2} + 3\sqrt{2}\mathbf{j}$

3 $f^{-1}(x) = \begin{cases} 4x & \text{for } x \leq 0 \\ \sqrt{x} & \text{for } 0 < x < 9 \\ x + 3 & \text{for } x \geq 9 \end{cases}$

4 All of them.

5 $f^{-1}(x) = (x - 3)^2 - 1$, Domain $\{x \in \mathbb{R}: x \geq 3\}$,
Range $\{y \in \mathbb{R}: y \geq -1\}$.

6 a $\mathbf{p} = 2\mathbf{i} + 3\mathbf{j} - 2\mathbf{k}$

b $\mathbf{q} = -2\mathbf{i} + 4\mathbf{j} + 3\mathbf{k}$

c 85° (to nearest degree)

d 61° (to nearest degree)

e 42° (to nearest degree)

7 $\frac{2}{3}\mathbf{i} + \frac{2}{3}\mathbf{j} - \frac{1}{3}\mathbf{k}$ 8 $\begin{pmatrix} 2 \\ -10 \\ -13 \end{pmatrix}$

9 Domain $\{x \in \mathbb{R}: 0 \leq x \leq 0.64\}$,
Range $\{y \in \mathbb{R}: 0 \leq y \leq 2\}$.

10 $(6\mathbf{i} + 8\mathbf{j})$ m/s, 10 m/s, $2\mathbf{j}$ m/s²

11 (Graph not shown here – check with a graphic calculator display.) $-7 \leq x \leq 7$

12 a $2a$ b $2ib$ c $a^2 + b^2$

d $\frac{a^2 - b^2}{a^2 + b^2} + i \frac{2ab}{a^2 + b^2}$

13 $\begin{pmatrix} -3 \\ 2 \\ 1 \end{pmatrix}$

14 $f \circ g(x) = x - 9$, Domain $\{x \in \mathbb{R}: x \geq 9\}$,
Range $\{y \in \mathbb{R}: y \geq 0\}$.

$g \circ f(x) = \sqrt{x^2 - 9}$, Domain $\{x \in \mathbb{R}: |x| \geq 3\}$,
Range $\{y \in \mathbb{R}: y \geq 0\}$.

15 $f \circ g(x) = 9 - x$, Domain $\{x \in \mathbb{R}: x \leq 9\}$,
Range $\{y \in \mathbb{R}: y \geq 0\}$.

$g \circ f(x) = \sqrt{9 - x^2}$, Domain $\{x \in \mathbb{R}: -3 \leq x \leq 3\}$,
Range $\{y \in \mathbb{R}: 0 \leq y \leq 3\}$.

16 a

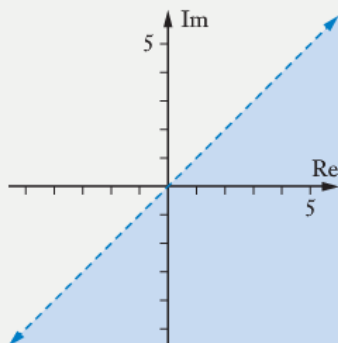

(Note the use of the dashed line to imply the line itself is not included.)

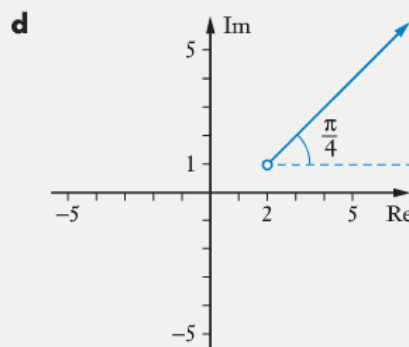
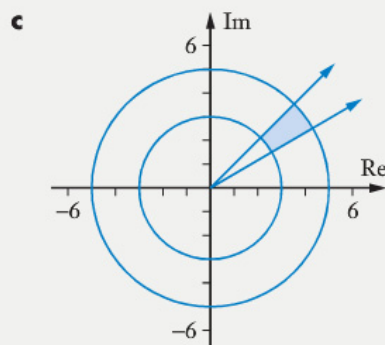
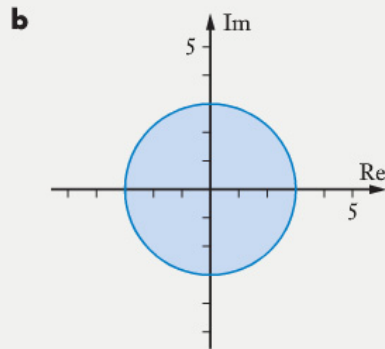

17 Points $z = x + iy$ satisfy the equation

$$\left(x + \frac{1}{3}\right)^2 + \left(y - \frac{4}{3}\right)^2 = \frac{8}{9},$$

i.e. a circle, centre $\left(-\frac{1}{3}, \frac{4}{3}\right)$ radius $\frac{2\sqrt{2}}{3}$.

18 Many possible answers, for example $\frac{1}{\sqrt{17}} \begin{pmatrix} 0 \\ -1 \\ 4 \end{pmatrix}$,

$\frac{1}{9} \begin{pmatrix} 1 \\ 4 \\ -8 \end{pmatrix}$, but all must be of the form

$$\frac{1}{\sqrt{a^2 + b^2 + c^2}} \begin{pmatrix} a \\ b \\ c \end{pmatrix} \text{ with } -8a + 4b + c = 0.$$

19 **a** 1 **b** 16 **c** 17
d 9 **e** 0.082 **f** 0.708

20 L_1 and L_2 do not intersect.

21 $a = 3, b = 5, c = 3, A(3, 1), B\left(5, \frac{5}{3}\right)$.

22 $\mathbf{r} = \begin{pmatrix} 5 \\ -1 \\ 1 \end{pmatrix}$

23 $a = 9, b = -4, c = 7, d = 12, e = 9, f = -10$

24 $-\mathbf{a} + 2\mathbf{b} - 3\mathbf{c}$

25 $\mathbf{r}_F = \mathbf{i} + 3\mathbf{j} - 2\mathbf{k}, c = 0, d = 9, e = 4$

26 **a** 1.07 radians

b $3\mathbf{i} + 3\mathbf{j} - 2\mathbf{k}$

c $\mathbf{r} \cdot (\mathbf{i} + 2\mathbf{j} - 2\mathbf{k}) = 13$

28 $8\cos^4\theta - 8\cos^2\theta + 1$

29 $-b + ai, -a - bi, b - ai$

30 Full method should be shown, leading to

a $x = 3, y = 0, z = 4$ **b** $x = 3, y = 1, z = -1$

31 $4x^2 - y^2 = 16$ (For $x \geq 2$.)

32 $(-40\mathbf{i} - 16\mathbf{j} - 12\mathbf{k})$ m/s, 670 m

33 **a** **i** $q = 0$ **ii** $q \neq 0$

b $x = 2q + 0.5, y = 0.5, z = -q$

c $x = 1, y = \frac{3}{8}, z = -\frac{1}{8}$

34 **a** $2\mathbf{i} + (3\pi - 1)\mathbf{j}$

b 3 m/s, $[4\mathbf{i} + (0.75\pi - 1)\mathbf{j}]$ m

36 The shortest distance from the line to the given point is 3 units.

37 **a** $\left[ut \cos \theta \mathbf{i} + \left(ut \sin \theta - \frac{gt^2}{2} \right) \mathbf{j} \right]$ m

b 34.9° or 76.9°

38 Student's conclusion is incorrect. The last equation, $0x + 0y + 0z = 0$, is true for all values of x, y and z , perhaps suggesting infinite solutions. However, looking to the other lines we still have three other equations involving three unknowns so a unique solution may still be possible. Indeed from these we obtain $x = 1, y = -1$ and $z = 3$ (and of course these values also fit $0x + 0y + 0z = 0$). The conclusion the student should have made is that the system has a unique solution of $x = 1, y = -1$ and $z = 3$.

39 **a** $[30\mathbf{i} + (24 - 10t)\mathbf{j}]$ m/s **b** $[30t\mathbf{i} + (24t - 5t^2)\mathbf{j}]$ m

c 2.4 s

d 4.5 s

e 28.8 m

f 6.75

41 $-6\sqrt{6}$

42 If looking for x, y and z values that satisfy all of the equations, the first equation, $x + 3y - z = 3$, and second equation, $-x - 3y + z = 3$ (i.e. $x + 3y - z = -3$) are contradictory. Hence no solution. The two equations represent distinct parallel planes, hence no points in common.

43 **a** $p = -4, q = -1$

b $p = -4, q \neq -1$

c $m = -1, n = 2, p = -2, q = 5$

44 No. Closest distance to light is $\sqrt{42}$ m which is greater than 6 m.



ANSWERS

UNIT FOUR

Exercise 8A PAGE 199

- 1 $-\frac{y+8}{x+2}$ 2 $\frac{6x-y+4}{x+1}$
- 3 $\frac{2(1+3xy)}{3(y^2-x^2)}$ 4 $\frac{6x^2y+5}{2(y-x^3)}$
- 5 $\frac{2x+2y-3}{2(5y-x)}$ 6 $\frac{2x+2y-1}{2(3y-x)}$
- 7 $\frac{9-2x}{2y}$ 8 $\frac{2x}{9-2y}$
- 9 $\frac{9y-2x}{2y-9x}$ 10 $\frac{9y+1-2x}{2y-9x-1}$
- 11 $\frac{\cos x}{\sin y}$ 12 $\frac{2(x \cos y - 5y)}{10x + x^2 \sin y}$
- 13 8 14 0.125
- 15 -1.2 16 -3.2
- 17 $y = x$ 18 $\frac{489}{212}$
- 19 $2xy + x^4y$ 20 (1, 1.5), (1, -3)
- 21 (1, -3), (3, -3)
- 22 $\frac{dy}{dx} = \frac{2x+1}{1-3y^2}$. At (1, 0), $\frac{dy}{dx} = 3$.
 $\frac{d^2y}{dx^2} = \frac{2(1-3y^2)^2 + 6y(2x+1)^2}{(1-3y^2)^3}$. At (1, 0), $\frac{d^2y}{dx^2} = 2$.
- 23 $6y = 4\sqrt{3}x + \pi - 4\sqrt{3}$
- 24 $\frac{dy}{dx} = \frac{\sin x}{2y-3}$, $\frac{d^2y}{dx^2} = \frac{(2y-3)^2 \cos x - 2 \sin^2 x}{(2y-3)^3}$

- 25 $\frac{dy}{dx} = \frac{x+1}{\cos y}$. At $(-2, \frac{\pi}{6})$, $\frac{dy}{dx} = -\frac{2\sqrt{3}}{3}$.
 $\frac{d^2y}{dx^2} = \frac{\cos^2 y + (x+1)^2 \sin y}{\cos^3 y}$.
 At $(-2, \frac{\pi}{6})$, $\frac{d^2y}{dx^2} = \frac{10\sqrt{3}}{9}$.
- 26 $(\frac{\sqrt{3}}{2}, \frac{3\sqrt{3}}{2})$ and $(-\frac{\sqrt{3}}{2}, -\frac{3\sqrt{3}}{2})$

Exercise 8B PAGE 201

- 1 a $6 \cos 2t$ b $-10 \sin 5t$ c $-\frac{5 \sin 5t}{3 \cos 2t}$
- 2 a $2 \sin t \cos t$ b $-3 \sin 3t$ c $-\frac{3 \sin 3t}{\sin 2t}$
- 3 $\frac{2t}{3}$ 4 $\frac{3}{2t}$ 5 $\frac{2(t+1)}{15t^2}$
- 6 $-\frac{1}{6(t+1)^3}$ 7 $\frac{t-1}{t}$ 8 $\frac{2(t-1)^2}{(t+1)^2}$
- 9 -1.5 10 -36
- 11 (14, -16), (2, 16)
- 12 a $\frac{\cos 2t}{\cos t}$ b $(2, \sqrt{3}), \frac{1}{\sqrt{3}}$
- c $\frac{\pi}{4}, \frac{3\pi}{4}, \frac{5\pi}{4}, \frac{7\pi}{4}$
- 13 a $\frac{t^2-2}{2t^2+1}$ b $\frac{10t^3}{(2t^2+1)^3}$

Exercise 8C PAGE 206

- 1** 200 **2** 1.5 **3** 2
4 a 0.5 **b** 36
5 0.15 **6** 0.25 **7** 0.36
8 -8 **9** $0.25 \text{ cm}^2/\text{s}$ **10** $\frac{1}{\sqrt{2}} \text{ cm}^2/\text{s}$
11 Decreasing at 0.075 cm/s
12 $0.16 \text{ cm}^2/\text{s}$ **13** $6 \text{ cm}^2/\text{s}$
14 $60\sqrt{3} \text{ cm}^2/\text{min}$
15 $0.4\pi r^2 \text{ cm}^3/\text{s}$ **a** $10\pi \text{ cm}^3/\text{s}$ **b** 10 cm
16 a $12 \text{ cm}^2/\text{s}$ **b** $30 \text{ cm}^3/\text{s}$
17 a $80 \text{ cm}/\text{min}$ **b** $40 \text{ cm}/\text{min}$
c $16 \text{ cm}/\text{min}$
18 a $3r^2 \text{ cm}^3/\text{s}$ **b** $4.8r \text{ cm}^2/\text{s}$
19 a 1.6 cm/s **b** 0.8 cm/s
20 a $4x(2x^2 - 3) \text{ m/s}^2$ **b** $5 \text{ m/s}, 40 \text{ m/s}^2$
21 $2\sqrt{3} \text{ cm}^2/\text{s}$
22 a i 4 cm/s **ii** 1 cm/s
b 22 mm/s
23 a $\frac{1}{32\pi} \text{ m}/\text{min}$ **b** $\frac{1}{4\pi} \text{ m}/\text{min}$
24 1090
25 a $\pi \text{ cm}^2/\text{s}$ **b** $2.5\pi \text{ cm}^3/\text{s}$
26 a $4.8\pi \text{ cm}^2/\text{s}$ **b** $14\pi \text{ cm}^3/\text{s}$
27 $\frac{25}{6} \text{ cm/s}$ **28** $27 \text{ mm}/\text{min}$
29 a shortening at 0.6 m/s **b** 2 m/s
30 a lengthening at 1 m/s **b** 3 m/s
31 $-\frac{1}{2\sqrt{3}} \text{ cm/s}$ **32** $\frac{180}{13} \text{ m/s}$ ($\approx 13.8 \text{ m/s}$)
33 4 m/s **34** $\frac{89\pi}{2} \text{ m/s}$ ($\approx 139.8 \text{ m/s}$)

Exercise 8D PAGE 212

- 1** $0.7, f(5.01) - f(5) = 0.701501$
2 $0.015, f\left(\frac{\pi}{9} + 0.01\right) - f\left(\frac{\pi}{9}\right) = 0.0146$ (to 4 decimal places)
3 $0.01125, f\left(\frac{\pi}{3} + 0.001\right) - f\left(\frac{\pi}{3}\right) = 0.0112659$
 (to 7 decimal places)
4 $\frac{10}{\sqrt{x}}$
a \$2 per unit **b** \$1 per unit
c \$0.50 per unit

- 5** $750 - 30x + \frac{3x^2}{10}$
a \$120 per tonne **b** \$30 per tonne
c \$750 per tonne
6 \$10 per unit. It will cost approximately \$10 to produce the 11th item.
7 a 12 cm^2 **b** 15 cm^3

Exercise 8E PAGE 213

- 3 a** $x^x(1 + \ln x)$ **b** $2x^{2x}(1 + \ln x)$
c $\frac{x^{\cos x}(\cos x - x \sin x \ln x)}{x}$
d $-\frac{3}{\sqrt{(3x+1)(3x-1)^3}}$

Miscellaneous exercise eight PAGE 214

- 1 a** $\frac{8}{(3-2x)^2}$ **b** $6 \sin^2(2x+1) \cos(2x+1)$
c $\frac{5-6xy}{3(x^2+y^2)}$ **d** $\frac{4t^3}{2t+3}$
2 $4y = -3x + 25$
3 a $2y^3$ **b** $\frac{2y^3(5-y^3)}{(2y^3+5)^3}$
4 a $\frac{40}{3} \text{ m}/\text{sec} \uparrow, \frac{4\sqrt{3}}{9} \text{ m}/\text{s}^2 \uparrow$.
b $40 \text{ m}/\text{sec} \uparrow, 4\sqrt{3} \text{ m}/\text{s}^2 \uparrow$.

Exercise 9A PAGE 219

- 1** $5(x^2 - 3)^6 + c$ **2** $-(-1 - 2x)^4(1 + 8x) + c$
3 $\frac{2}{63}(3x+1)^6(18x-1) + c$ **4** $\frac{1}{4}(2x^2-1)^6 + c$
5 $\frac{1}{3}(3x^2+1)^6 + c$ **6** $\frac{1}{7}(x-2)^6(3x+1) + c$
7 $-(4x+3)(3-x)^4 + c$ **8** $-\frac{1}{42}(5-2x)^6(12x+5) + c$
9 $\frac{1}{4}(2x+3)^4(8x-3) + c$ **10** $\frac{4}{15}(3x+1)^3(9x-2) + c$
11 $2\sqrt{3x^2+5} + c$ **12** $-(x+1)\sqrt{1-2x} + c$
13 $\frac{2}{3} \sin^6 2x + c$ **14** $-\frac{9}{8} \cos^8 3x + c$
15 $-3 \cos(x^2+4) + c$ **16** $\frac{1}{84}(2x+1)^6(24x+19) + c$

Exercise 9B PAGE 220

- 1** $\frac{1}{2}x^2 - \frac{1}{3}\cos 3x + c$ **2** $2x + c$
3 $-\frac{1}{8}\cos 8x + c$
4 $\frac{1}{2}\sin 2x + c$ (or $\frac{1}{2}(\cos x + \sin x)^2 + c$)
5 $\frac{2}{5}x^{\frac{5}{2}} + \frac{2}{3}x^{\frac{3}{2}} + c$ **6** $-2\cos(x^2) + c$
7 $-4\cos(x^2 - 3) + c$ **8** $\frac{16}{3}(1+3x)^{\frac{3}{2}} + c$
9 $\frac{2}{9}(1+3x)^{\frac{3}{2}}(9x-2) + c$ **10** $\frac{1}{10}\sin^5 2x + c$
11 $\frac{1}{28}(2x+7)^6(12x-7) + c$
12 $\frac{1}{2}(2x+7)^6 + c$ **13** $x^3 - 2x + c$
14 $\frac{1}{12}(3x^2 - 2)^8 + c$ **15** $\sin x - \frac{1}{2}\cos 2x + c$
16 $\frac{1}{54}(3x-2)^8(12x+1) + c$
17 $\frac{1}{2}x^2 + c$ **18** $6\sqrt{1+2x} + c$
19 $2(x-1)\sqrt{1+2x} + c$ **20** $\frac{1}{9}(x^2+x+1)^9 + c$
21 $-12\cos(x^2+3) + c$ **22** $\frac{3}{28}(x-5)^{\frac{4}{3}}(8x+37) + c$
23 $\frac{1}{3}(\sqrt{x}+5)^6 + c$ **24** $\frac{(2x-1)^6}{3} + c$
25 $\frac{1}{42}(2x-1)^6(12x+1) + c$
26 $-\frac{\cos^4 6x}{24} + c$ **27** $6\sqrt{x^2-3} + c$
28 $-\frac{\cos 4x}{8} + c$ or $\frac{\sin^2 2x}{4} + c$
29 $\frac{1}{168}(2x-1)^6(84x^2+12x+1) + c$

Exercise 9C PAGE 222

- 1** 160 **2** 113.6
3 125 **4** 2
5 9.28 **6** $12\frac{2}{3}$
7 8 square units **8** 72.9 square units

Exercise 9D PAGE 225

- 1** $\frac{1}{18}\sin 9x + \frac{1}{2}\sin x + c$
2 $\frac{1}{12}\sin 6x - \frac{1}{16}\sin 8x + c$
3 $\frac{1}{5}\sin^5 x + c$ **4** $\frac{3}{2}\sin^4 x + c$
5 $-\cos x + \frac{1}{3}\cos^3 x + c$ **6** $\sin x - \frac{1}{3}\sin^3 x + c$
7 $\sin x - \frac{2}{3}\sin^3 x + \frac{1}{5}\sin^5 x + c$
8 $\frac{x}{2} + \frac{\sin 2x}{4} + c$ **9** $\frac{x}{2} - \frac{\sin 2x}{4} + c$
10 $3x - 2\sin 2x + \frac{1}{4}\sin 4x + c$
11 $x + c$ **12** $\frac{1}{2}\sin 2x + c$
13 $-\cos x + \frac{1}{3}\cos^3 x + \frac{\sin 2x}{4} + \frac{x}{2} + c$
14 $-\frac{\cos 2x}{2} + c$ (or $\sin^2 x + c$ or $-\cos^2 x + c$)
15 $-\frac{1}{3}\cos^3 x + \frac{1}{5}\cos^5 x + c$ **16** $\frac{1}{3}\sin^3 x - \frac{1}{5}\sin^5 x + c$
17 $\frac{1}{3}\tan 3x - x + c$ **18** $\tan x + c$
19 $\tan x - x + c$ **20** $\frac{1}{5}\tan^5 x + c$
21 $2\pi^2$ square units
22 **a** $\mathbf{r} = (3 + 2t - \sin 2t)\mathbf{i} + (1 - t + \tan t)\mathbf{j}$
b $\mathbf{r}\left(\frac{\pi}{4}\right) = \left(2 + \frac{\pi}{2}\right)\mathbf{i} + \left(2 - \frac{\pi}{4}\right)\mathbf{j}$

Exercise 9E PAGE 231

- 1** $7\ln|x| + c$ **2** $x^3 - 4\ln|x| + c$
3 $4\ln(x^2+6) + c$ **4** $-\frac{1}{2}\ln|\cos 2x| + c$
5 $x + 2\ln|x| + c$ **6** $x - 2\ln|x+2| + c$
7 $2x - 3\ln|x| + c$ **8** $\frac{x}{2} + \frac{3}{4}\ln|2x-3| + c$
9 $\frac{x^2}{2} + x - 2\ln|x+3| + c$ **10** $3\ln|x| + 2\ln|x+1| + c$
11 $3\ln|x+2| + \ln|x-3| + c$
12 $3\ln|x-1| + \ln(x^2+6) + c$
13 $5\ln|x+1| + \ln|x^2+x-1| + c$

$$14 \quad 3\ln|x+1| + 2\ln|x-1| + \frac{4}{x-1} + c$$

$$15 \quad 2\ln|2x+1| + 2\ln|x-3| + \frac{5}{x-3} + c$$

Exercise 9F PAGE 233

$$1 \quad \frac{32\pi}{5} \text{ units}^3 \quad 2 \quad \frac{9\pi}{5} \text{ units}^3 \quad 3 \quad \frac{15\pi}{2} \text{ units}^3$$

$$4 \quad \frac{109\pi}{3} \text{ units}^3$$

$$5 \quad \text{a} \quad \frac{\pi}{2} \text{ units}^3 \quad \text{b} \quad \frac{\pi}{6} \text{ units}^3$$

$$6 \quad \frac{78\pi}{5} \text{ units}^3 \quad 7 \quad 18\pi \text{ units}^3 \quad 8 \quad 2\pi \text{ units}^3$$

$$9 \quad \frac{\pi^2}{2} \text{ units}^3 \quad 10 \quad \frac{2\pi}{15} \text{ units}^3 \quad 11 \quad \frac{24\pi}{5} \text{ units}^3$$

$$12 \quad 4\pi^2 \text{ units}^3 \quad 13 \quad \frac{4}{3}\pi r^3 \quad 14 \quad \frac{1}{3}\pi r^2 h$$

$$15 \quad 2\pi \text{ units}^3 \quad 16 \quad \frac{7\pi}{15} \text{ units}^3 \quad 17 \quad 108\pi \text{ cm}^3$$

$$18 \quad \frac{7\pi}{2} \text{ units}^3 \quad 19 \quad \frac{\pi^2}{16} \text{ m}^3, \frac{\pi^2}{16} \text{ m}^3$$

$$20 \quad 160\pi \text{ units}^3$$

$$21 \quad 2\pi \int_a^b xy \, dx \quad \text{a} \quad \frac{15\pi}{2} \text{ units}^3 \quad \text{b} \quad \frac{199\pi}{5} \text{ units}^3$$

$$22 \quad 2\pi \int_a^b xy \, dy \quad \text{a} \quad 2\pi \text{ units}^3 \quad \text{b} \quad \frac{7\pi}{3} \text{ units}^3$$

Miscellaneous exercise nine PAGE 239

$$1 \quad 6(2x+1)^2 \quad 2 \quad -12\sin 3x + 12\cos 4x$$

$$3 \quad \frac{\sin^3 x(4x \cos x - \sin x)}{x^2} \quad 4 \quad \frac{2 + \sin x + 2 \cos x}{(1 + \cos x)^2}$$

$$5 \quad \frac{2 \cos 2x}{(1 + \sin 2x)^2} \quad 6 \quad \frac{6x - 5y}{5x + 6y^2}$$

$$7 \quad \frac{-12t^2}{6t - 5} \quad 8 \quad \frac{\cos y - y \cos x}{\sin x + x \sin y}$$

$$9 \quad a = 1, b = 6, \ln|x-1| + 6\ln|x+1| + c$$

$$10 \quad \text{a} \quad \frac{1}{2} \sin 8x + c$$

$$\text{b} \quad \frac{1}{6}(3+x^2)^6 + c$$

$$\text{c} \quad \frac{3}{28}(x+3)^3(41-12x) + c$$

$$\text{d} \quad \frac{1}{12} \sin^6 2x + c$$

$$\text{e} \quad \frac{1}{2}x - \frac{1}{2} \sin x + c$$

$$\text{f} \quad 2 \sin \frac{x}{2} - \frac{2}{3} \sin^3 \frac{x}{2} + c$$

$$\text{g} \quad \frac{1}{6} \cos^3 2x - \frac{1}{2} \cos 2x + c$$

$$\text{h} \quad -4 \cos^3 x + c$$

$$\text{i} \quad -4 \cos^3 x + 6 \cos x + c$$

$$11 \quad \text{a} \quad y = 1.75x - 0.5 \quad \text{b} \quad 9y + 4x = 35$$

$$12 \quad (\pi \ln 4) \text{ units}^3 \quad 13 \quad 24 \text{ cm}^2/\text{s}$$

$$15 \quad -0.5 + \ln 3 \quad 16 \quad \frac{4}{5\pi} \text{ cm/sec}$$

$$17 \quad \text{a} \quad \frac{13}{3} \text{ m/s} \quad \text{b} \quad \frac{13}{3} \text{ m/s} \quad \text{c} \quad \frac{5}{3} \text{ m/s}$$

Exercise 10A PAGE 246

$$1 \quad y = 4x^2 - 5x + c \quad 2 \quad y = 4x^{\frac{3}{2}} + c$$

$$3 \quad 4y^2 = 2x^2 - x + c \quad 4 \quad \frac{3y^2}{2} = -\frac{5}{x} + c$$

$$5 \quad 7y^2 = -\frac{1}{x} + c \quad 6 \quad 2 \cos 2y = \frac{5}{x} + c$$

$$7 \quad y^2 - 3y = 4x^2 + x + c \quad 8 \quad 2y^2 - 5y = x^2 - x^3 + c$$

$$9 \quad \sin y = -\frac{1}{x} + c \quad 10 \quad (y^2 + 1)^6 = 3x^2 + c$$

$$11 \quad y = 3x^2 + 1 \quad 12 \quad y^2 = \frac{13}{3} - \frac{5}{3x}$$

$$13 \quad 2y + \sin y = x^2 + 3x + \pi - 3$$

$$14 \quad y^2 + 3y = x^4 + 4x^2 + 5$$

$$15 \quad \text{When } s = 3, v = 4\sqrt{7}$$

$$16 \quad \text{a} \quad a = 1$$

$$\text{b} \quad b = \sqrt{3 + \sqrt{3}}, \text{ gradient } -\frac{1}{2\sqrt{3 + \sqrt{3}}}$$

$$17 \quad \text{a} \quad \text{When } t = 20 \text{ the volume is } 30 \text{ cm}^3.$$

$$\text{b} \quad \text{Pumping ceases when } t = 48.$$

Exercise 10B PAGE 248

$$1 \quad \text{a} \quad 448 \quad \text{b} \quad 180804$$

$$2 \quad \text{a} \quad 17452 \quad \text{b} \quad 2590064$$

$$3 \quad \text{a} \quad 81873 \quad \text{b} \quad 60653$$

$$4 \quad \text{Approximately } 680 \text{ grams.}$$

$$5 \quad \text{Approximately } 7.36 \text{ kg.}$$

- 6 ~1733 years
 7 a 0.5 kg b 0.25 kg c 0.397 kg
 8 98.6% 9 ~22%
 10 Approximately 4200 years.
 11 Approximately 117 years.
 12 b Easier to divide into 72 mentally as it is an integer with many factors.
 13 12.9 minutes, i.e. approximately 13 minutes.
 Compare your answer regarding the forensic possibilities of this idea with that of others in your class.

Exercise 10C PAGE 252

- 1 a 0.885
 b Approximately 18.122 million.
 2 Approximately 53 500.
 3 Various ways of writing the answer, two of which are shown below.

$$y = \frac{150e^{0.6x}}{1 + 0.5e^{0.6x}} = \frac{300}{1 + 2e^{-0.6x}}$$

- 4 a According to the model, the limiting value of L is 200.

This means that when fully grown the length of the animal is 2 metres (or as near as makes no difference.)

- b Various ways of writing the answer, three of which are shown below.

$$\begin{aligned} L &= \frac{10\,200e^{0.4t}}{149 + 51e^{0.4t}} \\ &= \frac{10\,200}{51 + 149e^{-0.4t}} \\ &\approx \frac{200}{1 + 2.9216e^{-0.4t}}, \end{aligned}$$

the last of these being in the $\frac{K}{1 + Ce^{-at}}$ form.

- c Approximately 189.8 cm
 5 a $P = \frac{2500}{1 + 14.625e^{-0.2t}}$
 b 2500
 c Approximately 839
 6 Approximately 17 175

Exercise 10D PAGE 255

- 1 $\frac{dy}{dx} = 1$, Graph F. 2 $\frac{dy}{dx} + 2 = 0$, Graph J.
 3 $\frac{dy}{dx} = 4 - 2x$, Graph D. 4 $\frac{dy}{dx} = x(x - 3)$, Graph I.

- 5 $\frac{dy}{dx} = (x + 1)(3 - x)$, Graph E.
 6 $\frac{dy}{dx} = \sqrt{x}$, Graph G.
 7 $\frac{dy}{dx} = 2^x$, Graph H.
 8 $\frac{dy}{dx} = \frac{x}{2}$, Graph C.

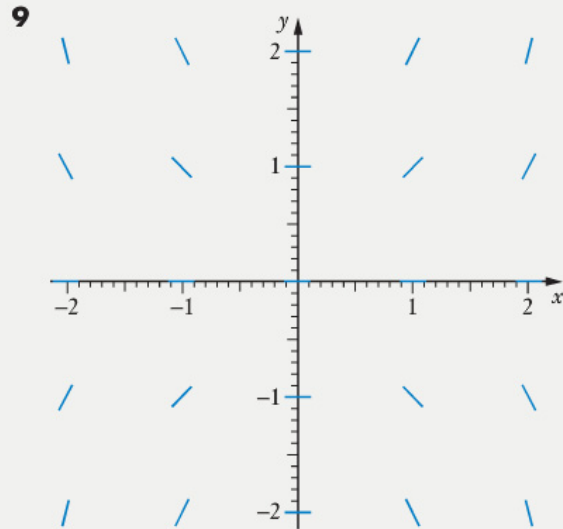

Miscellaneous exercise ten PAGE 260

- 1 $\frac{dy}{dx} = y - x$, slope field B.
 $\frac{dy}{dx} = \frac{x}{y}$, slope field C.
 $\frac{dy}{dx} = y - 1$, slope field A.
 3 $\delta y \approx 0.055$
 4 a $2 \cos x$ b $2 \sin x \cos x$
 c $\cos(\sin x) \cdot \cos x$ d $\frac{19}{(5 - 3x)^2}$
 e $6(2x + 3)^2$ f $\frac{3 \cos x - 2y}{2x + 3y^2}$
 g $\frac{2x^2 - y}{x(\ln x - 6y)}$ h $\frac{(5 - 3y)(1 + 2y)}{3(2xy + x - 2)}$
 5 $2y^2 = e^{2x} + 17$
 6 $y = -\frac{11}{3}x - \frac{10}{3}$ [at the point (1, -7)]
 and $y = -\frac{4}{3}x + \frac{10}{3}$ [at the point (1, 2)].



- 7 $6\pi \text{ units}^3$
- 8 a $\frac{(3x^2 - 5)^8}{48} + c$
 b $\frac{(8x + 5)(x - 5)^8}{72} + c$
 c $8\sqrt{x^2 - 3} + c$
 d $\frac{4}{75}(5x - 2)^{\frac{3}{2}}(15x + 4) + c$
 e $-4\cos(x^2 - 5) + c$
 f $\frac{(1 + e^x)^5}{5} + c$
 g $\frac{8}{3}\sqrt{x - 3}(x + 6) + c$
 h $-\frac{5 + 4x}{2(x + 2)^2} + c$
- 9 $\pi^2 \text{ cm}^3/\text{s}$ a $100\pi \text{ cm}^3/\text{s}$ b 16 cm
- 10 0.006 rad/s
- 11 $\frac{27}{16\pi} \text{ cm/s}$
- 13 a ~ 76.6 million tonnes b ~ 17.9 years

Exercise 11A PAGE 267

- 1 a 24 m/s^2 b 130 m
- 2 0.3 m/s
- 3 a -1 m/s b 0 m/s^2
- 4 a 4 m/s^2 b 7 m
- 5 a 4.5 m/s b $\left(5 + \frac{4\pi}{3} - \frac{\sqrt{3}}{4}\right) \text{ m}$
- 6 12 m/s^2
- 7 8 m/s
- 8 a 0.5 b $0.1e^2$
- 9 a $\frac{1}{(2t + 3)^2} \text{ m/s}, -\frac{4}{(2t + 3)^3} \text{ m/s}^2$
 b 0.4 m, 0.04 m/s, -0.032 m/s^2
- 10 7, 41 m/s
- 11 a 24 m/s b 8, 64 m
 c 40 m d 13 m
- 12 -10 m/s
- 13 a 2 m/s b $(4\cos 2t) \text{ m/s}^2$
 c 4 m/s^2 d $(1 - \cos 2t) \text{ m}$
 e 2 m

- 14 a $(9x + 6) \text{ m/s}^2$ b $14 \text{ m/s}, 42 \text{ m/s}^2$
- 15 $0.5 \ln(8.5) \text{ metres}$

Exercise 11B PAGE 275

- 1 a 5 m, π seconds b 4 m, 0.4π seconds
 c 2 m, 0.5π seconds
- 2 a π seconds b 2π seconds
 c 0.4π seconds
- 3 a $x = \sin 0.5t$ b $x = -\sin 0.5t$
 c $x = 3 \sin 2t$ d $x = -0.5 \sin \pi t$
- 4 a $x = 2 \cos 2t$ b $x = 1.5 \cos 4t$
 c $x = 0.5 \cos 4\pi t$
- 5 a $x = \pm 2.5 \sin 2t$ b 2.5 m/s
- 6 a $\sqrt{34} \text{ m}, 0.4\pi \text{ s}$ b $\sqrt{58} \text{ m}, \pi \text{ s}$
- 7 b 20 seconds, 4 m c 2.35 m
- 8 b 6 seconds, 2 m c $(4 - \sqrt{3}) \text{ m}$
- 9 b π seconds, 3 m c 2.76 m
- 10 a $x = 4 \sin\left(\pi t + \frac{5\pi}{6}\right)$ b $4\pi \text{ m/s}$
- 11 a $x = 2 \sin\left(5t + \frac{\pi}{4}\right)$ b 10 m/s
 c 50 m/s^2
- 12 a $\frac{3\sqrt{3}}{10} \text{ m}$ b $\frac{3\sqrt{3}}{10} \text{ m}$
 c i $\frac{\pi}{12}$ ii $\frac{5\pi}{12}$ iii $\frac{7\pi}{12}$
- 13 a $-\frac{3\sqrt{3}}{2} \text{ m}$ b $-\frac{3\pi}{2} \text{ m/s}$
 c $\frac{3\pi}{2} \text{ m/s}$ d $\frac{2}{3}$
- 14 a 0.96 seconds
 b 0.19 seconds
 c 0.42 seconds
 d 0.84 seconds, 2.30 seconds
- 15 0.72 seconds
- 16 a $x = 2 \sin 2t$ b $x = 4 \cos 2t$
- 17 a 2 cm b $\frac{\pi}{4}$ seconds
 c $\frac{\pi}{16}$ seconds d 16 cm/s
 e $\frac{\pi}{48}$ seconds
- 18 a 4 m b 2
 c 14.98 m

- 19 **b** 2 seconds, 4 m **c** 3 m
d 7 m
- 20 **b** π seconds, 3 m **c** 5 m
d 2 m
- 21 **a** 0.21 m **b** 0.27 m
- 22 π seconds, 25 m
- 23 $\frac{2\pi}{3}$ seconds, 0.65 m

Miscellaneous exercise eleven PAGE 279

- 1 **a** $6xy$ **b** $\frac{15 - 4y + 8 \cos 2x}{4x + 5y^4}$
- 2 Approx 34.7 years
- 3 **a** 0 m/s **b** $(3 \sin 2t) \text{ m/s}^2$
c $\frac{\pi}{4}$ **d** $(1.5t - 0.75 \sin 2t) \text{ m}$
e $\frac{2\pi - 3\sqrt{3}}{8} \text{ m}$
- 4 **a** $6x(3x^2 - 2) \text{ m/s}^2$ **b** 1 m/s, 6 m/s²
- 5 $y^3 = x^2 - 3$
- 6 0.04 rad/s, 1.6 m/s
- 7 $128\pi \text{ units}^3$ **8** $\frac{2}{3} \text{ units}^2$
- 9 **a** $\frac{28}{3} \text{ units}^2$ **b** $\frac{824\pi}{15} \text{ units}^3$
c $24\pi \text{ units}^3$
- 10 10 m/s
- 11 **a** $\frac{\pi}{2}$ seconds, 0, 0 m **b** $\frac{2\pi}{3}$ seconds, 5, 0 m
c π seconds, 2, 0 m **d** $\frac{2\pi}{5}$ seconds, 1, 1 m
- 12 $c = 5, d = 6, k_1 = 2, k_2 = 0.5$ Time period for A is π seconds and for B is 4π seconds.

Exercise 12A PAGE 293

- 1 The sample means will be approximately normally distributed with a mean of 3.5 and a standard deviation of 0.24 (i.e. $\frac{1.71}{\sqrt{50}}$).

If instead a sample size of 150 were used the distribution would still be approximately normal with a mean of 3.5 but with a smaller standard deviation than before, now 0.14 (i.e. $\frac{1.71}{\sqrt{150}}$).

- 2 The sample means will be approximately normally distributed with a mean of 2.375 and a standard deviation of 0.09 (i.e. $\frac{0.696}{\sqrt{60}}$).

If instead a sample size of 100 were used the distribution would still be approximately normal with a mean of 2.375 but with a smaller standard deviation than before, now 0.07 (i.e. $\frac{0.696}{\sqrt{100}}$).

- 3 The 100 sample means will be approximately normally distributed with a mean of 7 and a standard deviation of 0.40 (i.e. $\frac{2.415}{\sqrt{36}}$).

If instead a sample size of 120 were involved the sample means would still be approximately normally distributed with mean of 7 but with a smaller standard deviation than before, now 0.22 (i.e. $\frac{2.415}{\sqrt{120}}$).

- 4 0.946 5 0.040 6 0.685

- 7 **a** Y will be normally distributed with mean 5 and standard deviation 0.2 i.e. $Y \sim N(5, 0.2^2)$.

- b** 0.006

- 8 $Y \sim N(30, 0.24)$, i.e. normally distributed with mean 30 and standard deviation $\sqrt{0.24}$.

- 9 **a** 0.4% **b** 25% **c** 0.402

- 10 **a** 0.006 **b** 0.202 **c** 0.938

- 11 We would expect the mean length of samples of ten adult male lizards of this species to be normally distributed with mean 17.4 and standard deviation $\frac{2.1}{\sqrt{10}}$ cm, i.e. a standard deviation of approximately 0.664 cm. Thus a sample mean of 19.4 cm is just over three standard deviations above the mean. Whilst not impossible this is very unlikely. We would expect less than 0.13% of such samples to have a mean length this high. Hence, whilst it is possible that the sample of ten could be a 'freakish' sample we would be wise to consider other possible reasons for the surprising sample mean. Was the sample really a random sample? Perhaps the lizards were caught in a region where larger than normal lizards of this species were found. Perhaps the scientists' confidence in the assumption of a normal distribution or in the given population mean and standard deviation was misplaced. Were all of the lizards in the sample really adult males of this species? Etc.

- 12 **a** $\frac{1}{3}$ **b** $\sqrt{3}$ **c** 0.023

- 13 a** Sample means are normally distributed with mean 513, standard deviation $\frac{26}{8}$.

1.96 standard deviations either side of 513 gives interval of 506.63 \rightarrow 519.37.

505 is not in this interval.

Significant difference at the 5% level.

- b** Sample means are normally distributed with mean 513, standard deviation $\frac{26}{10}$.

1.96 standard deviations either side of 513 gives interval of 507.90 \rightarrow 518.10

510 is in this interval.

There is not a significant difference at the 5% level.

Exercise 12B PAGE 300

- The 90% confidence interval has the smaller width. (If you want to be more confident of catching the population mean you need a bigger net.)
- The 95% confidence interval has the smaller width.
- The bigger size sample will give the narrower 95% confidence interval.
- $565 \text{ cm} \leq \mu \leq 581 \text{ cm}$
- $25.12 \text{ kg} \leq \mu \leq 27.16 \text{ kg}$
- $16.51 \text{ cm} \leq \mu \leq 17.89 \text{ cm}$
- Note that we can assume that the sample mean is from a normal distribution of sample means because, though the sample is small, the population the sample is taken from is normally distributed. The 95% confidence interval is $73.73 \text{ cm} \leq \mu \leq 75.47 \text{ cm}$.
We can be 95% confident that the mean length of 12 month old baby girls lies between 73.73 cm and 75.47 cm (because 95% of the 95% confidence intervals constructed in this way will contain the population mean).
- $17.18 \text{ cm} \leq \mu \leq 18.42 \text{ cm}$
We can be 90% confident that the mean length of three month old seedlings of the particular plant type will lie between 17.18 cm and 18.42 cm (because 90% of the 90% confidence intervals constructed in this way will contain the population mean).
- $17.93 \text{ cm} \leq \mu \leq 18.67 \text{ cm}$, $17.99 \text{ cm} \leq \mu \leq 18.61 \text{ cm}$

Exercise 12C PAGE 303

- 110
- 372
- 23 (Okay to have a sample less than 30 as sample is taken from a normally distributed variable so sample means will be normally distributed.)
- 48
- 200
- 35

Miscellaneous exercise twelve PAGE 304

- 7
 - $\frac{x^2}{4} - 24x + 800$
- $-\frac{x(3x+4y)}{2x^2+3y^2}$
- $\frac{x^3-y}{x+y^3}$
 - $\frac{7}{3}$
- Slope field A, $y' = y$. Slope field B, $y' = x$. Slope field C, $y' = (x-3)(y-2)$.
- $3x + \ln|x+1| + \ln|x^2-2| + c$
- $\sin^3 k \text{ units}^2$
 - $(2 - \sin^3 k) \text{ units}^2$
- 0.32 m/s^2
 - $50\sqrt{e} - 30$
- $3e^{2t} + 1$
 - $3e + 1$
 - 0.06
- 6.93 years
 - 13.86 years
 - 20.79 years
- $52.19 \leq \text{population mean} \leq 54.29$
 - $51.99 \leq \text{population mean} \leq 54.49$
 - $51.59 \leq \text{population mean} \leq 54.89$
- 217.4 hours to 228.6 hours
We can be 95% confident that the mean life time of the population of triple A batteries of this brand will lie between 217.4 hours and 228.6 hours (because 95% of such 95% confidence intervals will contain the population mean).
- 8.40 a.m. to 6 p.m.
- 0.044
- 0.4 m/s
- $\frac{4}{41} \text{ rad/sec}$
- 0.0334
 - 0.5889
 - 0.3085
- $36 \text{ cm}, \frac{1}{2\pi} \text{ cm/s}$
- About 5 minutes to 8 that morning. (The mathematics suggests 7.54 a.m.)

- 19 a** 62 (or more).
b If we use the standard deviation of the population as 65 we could be 95% confident that the population mean lies in the interval 1787 hours to 1813 hours (i.e. 1800 ± 13). The claimed mean of 1850 hours is well outside this range and casts very serious doubt about the legitimacy of the claimed mean value.

20 $2x + \ln|x+1| + 3\ln|x+2| - \ln|x-3| + c$

21 a $N = \frac{6250}{1 + 24e^{-0.4t}}$

b As $t \rightarrow \infty$, $e^{-0.4t} \rightarrow 0$ and so $N \rightarrow 6250$.

c i 1970 **ii** 5220

23 a $\sin^{-1}x + c$

b $\sin^{-1}\left(\frac{x}{5}\right) + c$

c $\frac{1}{2}\sin^{-1}\left(\frac{2x}{3}\right) + c$

d $\frac{1}{2}\sin^{-1}x + \frac{1}{2}x\sqrt{1-x^2} + c$

e $2\sin^{-1}\left(\frac{x}{2}\right) + \frac{1}{2}x\sqrt{4-x^2} + c$

f $\frac{x}{2}\sqrt{4-x^2} - 2\cos^{-1}\left(\frac{x}{2}\right) + c$



INDEX

A

abbreviated form for $\cos\theta + i\sin\theta$ 16
absolute value functions 56–67
 extension activity 77
absolute values ix, 56–67
 extension activity 77
 solving equations involving 58–61
 solving inequalities involving 62–4
 of x as $\sqrt{x^2}$ 57
addition, complex numbers xvi, xviii
addition, vectors xii, xviii
algebraic expressions x
algebraic fractions 5
amplitude (simple harmonic motion) 269
angle between two lines 118–19
angle between vectors xv
antidifferentiation xxi, 191, 193
argand diagrams xvii–xviii, 13–14
 cube roots of one 27–8
 and regions in the complex plane 22–6
argument of a complex number 13
 addition and subtraction 18
augmented matrix approach 150–3, 158–61, 163

C

Cartesian equations 105–6
 of a circle 102–3
 of a curve 101
 of a straight line 89–90
 of the plane 129
Cartesian form of a complex number 14
central limit theorem 289
chain rule 200, 202
change of variable method 217–21
 and definite integrals 221–2
circles
 equations of xviii
 vector equations 101–4, 105–6
circular motion with constant angular speed 180
 $\text{cis}\theta$ 16–17
closest approach 107–10
co-domain 39
coefficient matrix 150

coefficients ix, 149
collision *see* interception/collision
column matrix xiii
combining functions 40–1
completing the square xi
complex conjugate of z xvii, 17–18
complex numbers xvi–xviii, 3–4
 de Moivre's theorem 31–35
 n th root of a non zero complex number 28–31
 in polar form 13–35
 multiplying and dividing 18–21
complex plane xvii
 locus of points 22
 regions in 22–6
composite functions x, 42–8
confidence intervals 296–301
 and sample size 302
conjugate of a complex number xvii, 17–18
cross product *see* vector product
cube roots of one 27–8
cubic functions x

D

De Moivre's theorem 31–5
definite integrals 193
 and change of variable method 221–2
derivatives xix–xx, xxi
determinant xxiii, 124
difference of two squares x
differential equations 243–59, 270
 Euler's method for finding approximate graphical solutions
 258–9
 finding relationships between x and y without integrating 254–9
 of the form $\frac{dA}{dt} = kA$, or $\dot{x} = kx$ 247–9
 general solution 244
 logistic model for growth 250–3
 particular solution 244–5
 slope fields 254–7
differentiation xix–xx, 191
 implicitly defined functions 195–9
 logarithmic 213
 parametrically defined functions 200–1
 rates of change 202–12
 techniques and applications 195–213
 vector functions 171–3



direction fields 254
 displacement equation, $x = a \sin(kt + \alpha)$ 270–1
 displacement vectors xiv
 distance from a point to a line
 in two dimensions 109–10
 in three dimensions 140–1
 distribution of sample means 284–5, 289
 dividing
 complex numbers xvii
 complex numbers expressed in polar form 18, 19, 20–1
 domain ix, 39, 41
 functions of the form $f \circ g(x)$ 43–8
 inverse functions 49
 natural 39, 43
 dot product xv

E

elementary row operations 150
 ellipses, vector equations 105
 elliptical motion 181
 equation of a circle xviii, 101–4
 equation of the plane 128–30, 158
 given three points that lie in the plane 131–2
 Euler's method 258–9
 expanding algebraic expressions x
 explicitly defined functions 195

F

factor theorem 6
 factorising algebraic expressions x
 fractions (algebraic)
 improper 5, 69
 partial 229–30
 proper 5
 function of a function x
 functions ix–x, 39–78
 absolute value 56–7, 77
 combining 40–1
 composite x, 42–8
 graphical relationship between a function and its inverse 51
 horizontal line test 40
 inverse 49–55
 many-to-one 39, 40, 51
 one-to-one 39, 40, 51
 rational 69–76, 78
 using the output from one function as the input of another
 x, 42–3
 vertical line test 40

G

Gaussian elimination 151
 gradient xix
 gradient fields 254
 gradient formula xix, xx
 gradient function xix, xx, xxi
 graphs
 sketching xx
 $y = \frac{1}{f(x)}$ 67–9
 $y = \frac{f(x)}{g(x)}$ for $f(x)$ and $g(x)$ polynomials 69–76

H

horizontal line test 40
 horizontal and vertical components (vectors) xiii
 hyperbolas, vector equations 105

I

implicitly defined functions 195
 differentiation 195–8
 improper algebraic fractions 5, 69
 inconsistent equations 157
 incremental formula 211, 258
 infinitely many solutions
 (systems of linear equations) 159–60, 163–6
 instantaneous rate of change xix
 integration xxi, 191, 193
 by parts 238
 by substitution (change of variable) 217–21
 definite integrals and change of variable 221–2
 numerical 236–7
 techniques and applications 217–38
 to give logarithmic functions 227–9
 using partial fractions 229–31
 using trigonometric identities 223–6
 vector functions 174–7
 volumes of revolution 232–5
 interception/collision
 three dimensions 133, 135–6
 x–y plane 83, 84–7
 inverse functions 49–50
 conditions for the inverse to exist as a function 51–5
 graphical relationship between a function and its inverse 51



L

limit of a sum 193
 linear equations, systems of 147–66
 linear functions *x*
 linear inequalities *xi*
 locus of points in a complex plane 22
 logarithmic differentiation 213
 logarithmic functions, integration to give 227–9
 logistic equation 250
 logistic model for growth 250–3

M

magnitude of a complex number 13
 magnitude of a vector *xiii*
 many-to-one functions 39, 40, 51
 marginal rates of change 211–12
 matrices *xxii–xxiii*
 matrix of coefficients 150
 mean 283
 mean of sample means 285, 289
 modulus of a complex number 13, 14
 multiplication/division 18
 modulus of a vector *xiii*
 motion
 circular, with constant angular speed 180
 elliptical 181
 point on the rim of a rolling wheel 181
 particle projected from a point on a horizontal plane 178, 179–80
 projectile up an inclined plane 181
 rectilinear, with constant acceleration 179
 multiplying
 complex numbers *xvi–xvii*
 complex numbers in polar form 18, 19, 20–1
 geometrical interpretation 19

N

natural domain *ix*, 39, 43
 90% confidence interval 296, 297
 95% confidence interval 296, 297, 301
 99% confidence interval 296, 297
 no solutions (systems of linear equations) 157–8, 160–1, 163–6
 normal distribution 283, 289, 290
 n th root of a non zero complex number 28–31
 number *viii*
 numerical integration 236–7

O

one-to-many relationships 39, 51
 one-to-one functions 39, 40, 51
 order of the differential equation 244
 order of the polynomial *x*
 ordered pair (complex numbers) *xvii*, 14
 ordered pair (vectors) *xiii*

P

parallel vectors *xii*
 parallelogram law *xii*
 parametric equations 90, 101, 105, 127
 parametrically defined functions, differentiation 200–1
 partial fractions 229–30
 period (simple harmonic motion) 271
 point of intersection of two straight lines 95–7
 polar form of a complex number 13–35
 abbreviated form for $\cos \theta + i \sin \theta$ 16–17
 complex conjugates 17–18
 multiplying and dividing 18, 19, 20–1
 polynomial functions *ix–x*
 population 283
 population mean 283, 289
 and confidence intervals 296–301
 and sample mean 296, 297
 estimating and sample size 302–3
 population parameters 283
 inferring from sample statistics 296–300
 population standard deviation 297
 position vectors *xiv*
 primitives *xxi*
 principal argument of a complex number 13–14
 projectile up an inclined plane 181
 projection of **a** onto **b** (vectors) *xv*
 proper algebraic fractions 5
 Pythagorean identities *xxii*

Q

quadratic functions *x*

R

random sample 284
 range ix, 39, 41
 functions of the form $f \circ g(x)$ 43–8
 inverse functions 49
 rates of change
 instantaneous xix
 marginal 211–2
 related 202–10
 small changes 211
 rational functions 69–76, 78
 real valued functions 39
 reciprocal trigonometric functions xxii
 rectangular form a complex number 14
 rectilinear motion 265–9
 with constant acceleration 179
 regions in the complex plane 22–6
 related rates 202–210
 relative velocity xiv, 108
 remainder theorem 6
 resolved part of \mathbf{a} in the direction of \mathbf{b} xv
 resultant xii
 rotation about the x -axis 232, 233–5
 rotation about the y -axis 232, 234, 235
 row echelon form 150, 151

S

sample means
 distribution of 284–5, 289
 increasing the number of samples 285–6
 increasing the sample size 286–7
 and population mean 296, 297
 significant difference at the 5% level 292
 that are unusually high or unusually low 292–3
 sample size
 and central limit theorem 289–91
 and confidence intervals 302–3
 choosing 302–3
 increasing 286–7
 sample standard deviation 297
 sample statistic 283
 inferring population parameters from 296–300
 sampling 283–4
 scalar multiples xii, xiii
 scalar product xv, 95, 124, 140
 scalar product and vector equation of a plane 128–9
 scalar product form of the equation of a straight line in the x - y
 plane 98–100
 scalars xi
 separating the variables 245, 247

simple harmonic motion (SHM) 269–78
 displacement equation $x = a \sin(kt + \alpha)$ 270, 271
 solving the differential equation $\ddot{x} = -k^2x$ 270
 time period $\frac{2\pi}{k}$ 271

Simpson's rule 236
 sketching graphs xx
 $y = \frac{1}{f(x)}$ 67–9
 $y = \frac{f(x)}{g(x)}$ for $f(x)$ and $g(x)$ polynomials 69–76
 skew lines 118–9
 slope fields 254–7
 small changes formula 211, 258
 solving equations xi
 involving absolute values 58–61
 solving inequalities, involving absolute values 62–4
 spheres, vector equations 137–9
 standard deviation of sample means 285, 289
 standard error of the mean 285
 standard normal distribution 292, 296
 statistics 191
 substitution, integration by 217–21
 subtraction, complex numbers xvi
 systems of linear equations 147–66
 having infinitely many solutions 159–60, 163–6
 having no solutions 157–8, 160–1, 163–6
 having a unique solution 157, 161–2, 163–4, 166
 solving with/without an augmented matrix 149–56, 160–4

T

three dimensional vectors 115–41
 time period (simple harmonic motion) 271
 trapezium rule 236
 trapezoidal rule 236
 trigonometric identities xxii, 192
 in integration 223–6

U

unique solution (system of linear equations) 157, 161–2, 163–4, 166



V

- vector addition xii, xviii
- vector calculus 171–81
 - differentiating vector functions 171–3
 - integrating vector functions 174
 - types of motion 178–81
- vector equation of a line in the x - y plane 88–95
 - closest approach 107–8
 - distance from a point to a line 109–10
 - interception/collision 83, 84–7
 - point of intersection of two straight lines 95–7
 - scalar product form 98–100
- vector equation of a line (three dimensions) 126–7, 134–6
- vector equation of the plane 128–30, 134–6
- vector equations
 - of circles in the x - y plane 101–4, 105–6
 - of curves in the x - y plane 101, 105
 - of ellipses 105
 - of hyperbolas 105
 - of spheres 137–9
- vector functions 171
 - differentiating 171–3
 - integrating 174
- vector normal to a plane 124
- vector product 124–6, 141
- vector subtraction xiii
- vector triangle xii
- vectors in two dimensions xi–xv
 - horizontal and vertical components xiii
- vectors in three dimensions 115–41
 - angle between two lines 118–9
 - distance from a point to a line 140–1
 - interception/collision 133, 135–6
 - vector equation of a line 126–7, 134–6
 - vector equation of a plane 128–32, 134–6
 - vector equation of a sphere 137–9
- velocity of A relative to B xiv
- vertical line test 40
- volumes of revolution 232–5

Z

- 'z' scores 292, 296
- zero vector xiii

Western Australia's leading senior mathematics series for over 25 years has had a makeover, introducing a new colourful page design.

Written by **Alan Sadler**, these textbooks cover the three new senior mathematics ATAR courses for WA and the Australian Curriculum.

This new series caters to students of Mathematics Applications, Mathematics Methods and **Mathematics Specialist** across Units 1 to 4.



Mathematics Specialist Units 1 & 2
ISBN: 9780170390477



Mathematics Specialist Units 3 & 4
ISBN: 9780170395274

This new format contains the same text as in the original format, so that both formats can be used in the classroom concurrently.

Features **Preliminary Work** at the start of each unit and **Miscellaneous Exercises** at the end of each chapter.



Includes the **NelsonNetBook** version of this book with hotlinks to additional worksheets, plus student and teacher websites (*access conditions apply*).

For more information contact the relevant state Education Consultant at **www.nelsonsecondary.com.au** or visit **www.nelsonnet.com.au**



Mathematics Applications Unit 1 Student Book
ISBN: 9780170390194

Mathematics Applications Unit 2 Student Book
ISBN: 9780170390262

Mathematics Applications Unit 3 Student Book
ISBN: 9780170394994

Mathematics Applications Unit 4 Student Book
ISBN: 9780170395069

Mathematics Methods Unit 1 Student Book
ISBN: 9780170390330

Mathematics Methods Unit 2 Student Book
ISBN: 9780170390408

Mathematics Method Unit 3 Student Book
ISBN: 9780170395137

Mathematics Method Unit 4 Student Book
ISBN: 9780170395205

